

# DATA SHEET

**BFG135**

**NPN 7GHz wideband transistor**

Product specification  
File under discrete semiconductors, SC14

1995 Sep 13

## NPN 7GHz wideband transistor

## BFG135

## DESCRIPTION

NPN silicon planar epitaxial transistor in a plastic SOT223 envelope, intended for wideband amplifier applications. The small emitter structures, with integrated emitter-ballasting resistors, ensure high output voltage capabilities at a low distortion level.

The distribution of the active areas across the surface of the device gives an excellent temperature profile.

## PINNING

PIN	DESCRIPTION
1	emitter
2	base
3	emitter
4	collector

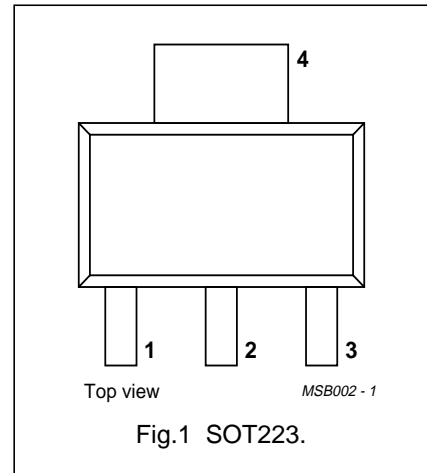

## QUICK REFERENCE DATA

SYMBOL	PARAMETER	CONDITIONS	MIN.	TYP.	MAX.	UNIT
$V_{CB0}$	collector-base voltage	open emitter	–	–	25	V
$V_{CE0}$	collector-emitter voltage	open base	–	–	15	V
$I_C$	DC collector current		–	–	150	mA
$P_{tot}$	total power dissipation	up to $T_s = 145\text{ °C}$ (note 1)	–	–	1	W
$h_{FE}$	DC current gain	$I_C = 100\text{ mA}$ ; $V_{CE} = 10\text{ V}$ ; $T_j = 25\text{ °C}$	80	130	–	
$f_T$	transition frequency	$I_C = 100\text{ mA}$ ; $V_{CE} = 10\text{ V}$ ; $f = 1\text{ GHz}$ ; $T_{amb} = 25\text{ °C}$	–	7	–	GHz
$G_{UM}$	maximum unilateral power gain	$I_C = 100\text{ mA}$ ; $V_{CE} = 10\text{ V}$ ; $f = 500\text{ MHz}$ ; $T_{amb} = 25\text{ °C}$	–	16	–	dB
		$I_C = 100\text{ mA}$ ; $V_{CE} = 10\text{ V}$ ; $f = 800\text{ MHz}$ ; $T_{amb} = 25\text{ °C}$	–	12	–	dB
$V_o$	output voltage	$d_{im} = -60\text{ dB}$ ; $I_C = 100\text{ mA}$ ; $V_{CE} = 10\text{ V}$ ; $R_L = 75\text{ }\Omega$ ; $T_{amb} = 25\text{ °C}$ ; $f_{(p+q-r)} = 793.25\text{ MHz}$	–	850	–	mV

## LIMITING VALUES

In accordance with the Absolute Maximum System (IEC 134).

SYMBOL	PARAMETER	CONDITIONS	MIN.	MAX.	UNIT
$V_{CB0}$	collector-base voltage	open emitter	–	25	V
$V_{CE0}$	collector-emitter voltage	open base	–	15	V
$V_{EBO}$	emitter-base voltage	open collector	–	2	V
$I_C$	DC collector current		–	150	mA
$P_{tot}$	total power dissipation	up to $T_s = 145\text{ °C}$ (note 1)	–	1	W
$T_{stg}$	storage temperature		–65	150	°C
$T_j$	junction temperature		–	175	°C

## Note

- $T_s$  is the temperature at the soldering point of the collector tab.

## NPN 7GHz wideband transistor

BFG135

## THERMAL CHARACTERISTICS

SYMBOL	PARAMETER	CONDITIONS	THERMAL RESISTANCE
$R_{th\ j-s}$	thermal resistance from junction to soldering point	up to $T_s = 145\text{ °C}$ (note 1)	30 K/W

## Note

- $T_s$  is the temperature at the soldering point of the collector tab.

## CHARACTERISTICS

$T_j = 25\text{ °C}$  unless otherwise specified.

SYMBOL	PARAMETER	CONDITIONS	MIN.	TYP.	MAX.	UNIT
$I_{CBO}$	collector cut-off current	$I_E = 0$ ; $V_{CB} = 10\text{ V}$	–	–	1	$\mu\text{A}$
$h_{FE}$	DC current gain	$I_C = 100\text{ mA}$ ; $V_{CE} = 10\text{ V}$	80	130	–	
$C_c$	collector capacitance	$I_E = i_e = 0$ ; $V_{CB} = 10\text{ V}$ ; $f = 1\text{ MHz}$	–	2	–	pF
$C_e$	emitter capacitance	$I_C = i_c = 0$ ; $V_{EB} = 0.5\text{ V}$ ; $f = 1\text{ MHz}$	–	7	–	pF
$C_{re}$	feedback capacitance	$I_C = 0$ ; $V_{CE} = 10\text{ V}$ ; $f = 1\text{ MHz}$	–	1.2	–	pF
$f_T$	transition frequency	$I_C = 100\text{ mA}$ ; $V_{CE} = 10\text{ V}$ ; $f = 1\text{ GHz}$ ; $T_{amb} = 25\text{ °C}$	–	7	–	GHz
$G_{UM}$	maximum unilateral power gain	$I_C = 100\text{ mA}$ ; $V_{CE} = 10\text{ V}$ ; $f = 500\text{ MHz}$ ; $T_{amb} = 25\text{ °C}$	–	16	–	dB
		$I_C = 100\text{ mA}$ ; $V_{CE} = 10\text{ V}$ ; $f = 800\text{ MHz}$ ; $T_{amb} = 25\text{ °C}$	–	12	–	dB
$V_o$	output voltage	note 1	–	900	–	mV
		note 2	–	850	–	mV
$d_2$	second order intermodulation distortion	$I_C = 90\text{ mA}$ ; $V_{CE} = 10\text{ V}$ ; $V_O = 50\text{ dBmV}$ ; $T_{amb} = 25\text{ °C}$ ; $f_{(p+q)} = 450\text{ MHz}$ ; $f_p = 50\text{ MHz}$ ; $f_q = 400\text{ MHz}$	–	–58	–	dB
		$I_C = 90\text{ mA}$ ; $V_{CE} = 10\text{ V}$ ; $V_O = 50\text{ dBmV}$ ; $T_{amb} = 25\text{ °C}$ ; $f_{(p+q)} = 810\text{ MHz}$ ; $f_p = 250\text{ MHz}$ ; $f_q = 560\text{ MHz}$	–	–53	–	dB

## Notes

- $d_{im} = -60\text{ dB}$  (DIN 45004B);  $I_C = 100\text{ mA}$ ;  $V_{CE} = 10\text{ V}$ ;  $R_L = 75\ \Omega$ ;  $T_{amb} = 25\text{ °C}$ ;  
 $V_p = V_o$  at  $d_{im} = -60\text{ dB}$ ;  $f_p = 445.25\text{ MHz}$ ;  
 $V_q = V_o - 6\text{ dB}$ ;  $f_q = 453.25\text{ MHz}$ ;  
 $V_r = V_o - 6\text{ dB}$ ;  $f_r = 455.25\text{ MHz}$ ;  
measured at  $f_{(p+q-r)} = 443.25\text{ MHz}$ .
- $d_{im} = -60\text{ dB}$  (DIN 45004B);  $I_C = 100\text{ mA}$ ;  $V_{CE} = 10\text{ V}$ ;  $R_L = 75\ \Omega$ ;  $T_{amb} = 25\text{ °C}$ ;  
 $V_p = V_o$  at  $d_{im} = -60\text{ dB}$ ;  $f_p = 795.25\text{ MHz}$ ;  
 $V_q = V_o - 6\text{ dB}$ ;  $f_q = 803.25\text{ MHz}$ ;  
 $V_r = V_o - 6\text{ dB}$ ;  $f_r = 805.25\text{ MHz}$ ;  
measured at  $f_{(p+q-r)} = 793.25\text{ MHz}$ .

## NPN 7GHz wideband transistor

BFG135

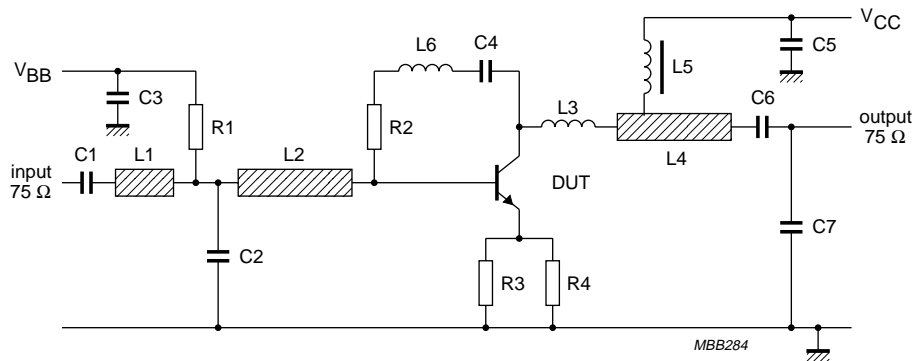

Fig.2 Intermodulation distortion and second order intermodulation distortion test circuit.

## List of components (see test circuit)

DESIGNATION	DESCRIPTION	VALUE	UNIT	DIMENSIONS	CATALOGUE NO.
C1, C3, C5, C6	multilayer ceramic capacitor	10	nF		2222 590 08627
C2, C7	multilayer ceramic capacitor	1	pF		2222 851 12108
C4 (note 1)	miniature ceramic plate capacitor	10	nF		2222 629 08103
L1	microstripline	75	$\Omega$	length 7 mm; width 2.5 mm	
L2	microstripline	75	$\Omega$	length 22mm; width 2.5 mm	
L3 (note 1)	1.5 turns 0.4 mm copper wire			int. dia. 3 mm; winding pitch 1 mm	
L4	microstripline	75	$\Omega$	length 19 mm; width 2.5 mm	
L5	Ferroxcube choke	5	$\mu$ H		3122 108 20153
L6 (note 1)	0.4 mm copper wire	$\approx$ 25	nH	length 30 mm	
R1	metal film resistor	10	k $\Omega$		2322 180 73103
R2 (note 1)	metal film resistor	200	$\Omega$		2322 180 73201
R3, R4	metal film resistor	27	$\Omega$		2322 180 73279

## Note

- Components C4, L3, L6 and R2 are mounted on the underside of the PCB.  
The circuit is constructed on a double copper-clad printed circuit board with PTFE dielectric ( $\epsilon_r = 2.2$ ); thickness  $\frac{1}{16}$  inch; thickness of copper sheet  $\frac{1}{32}$  inch.

NPN 7GHz wideband transistor

BFG135

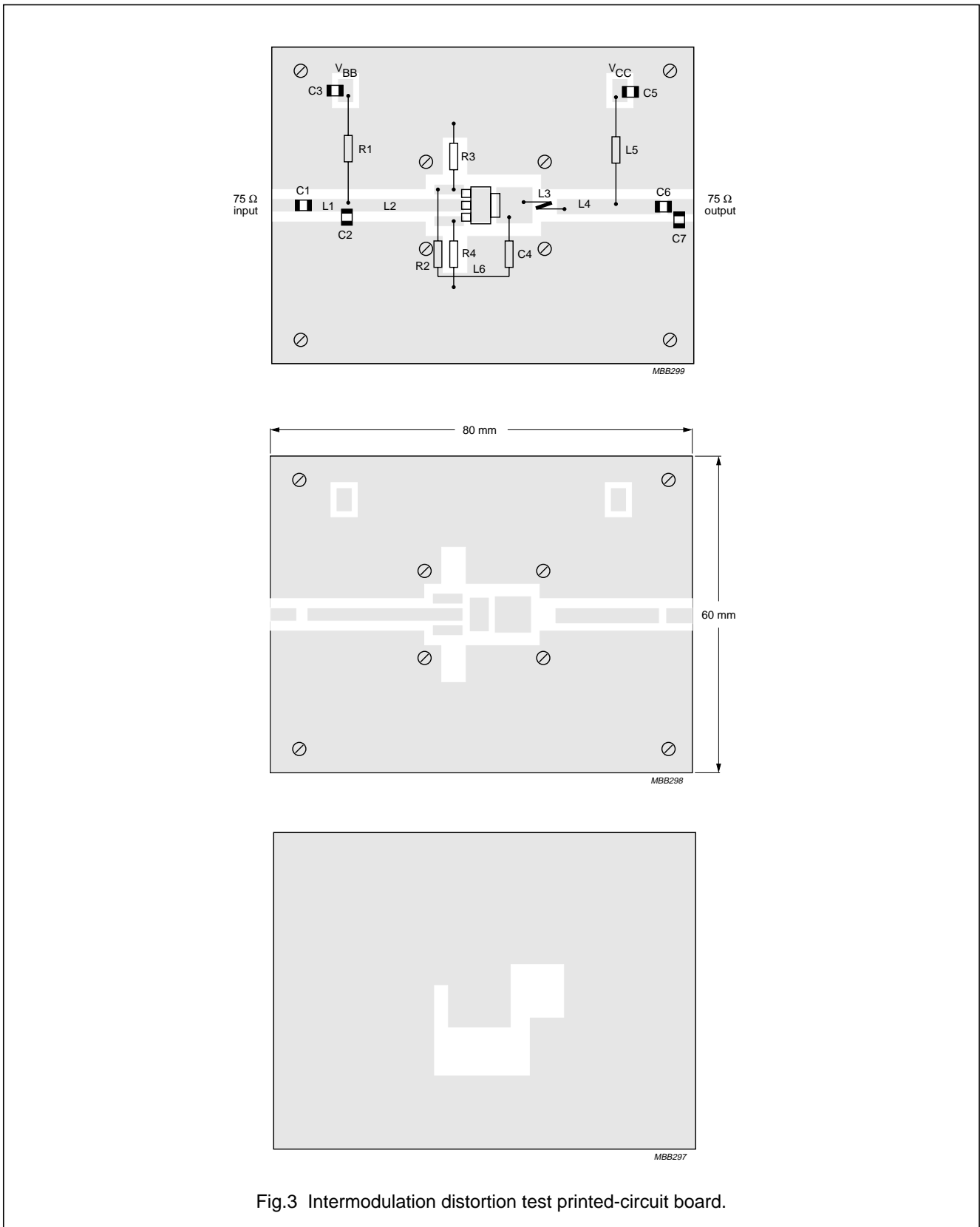
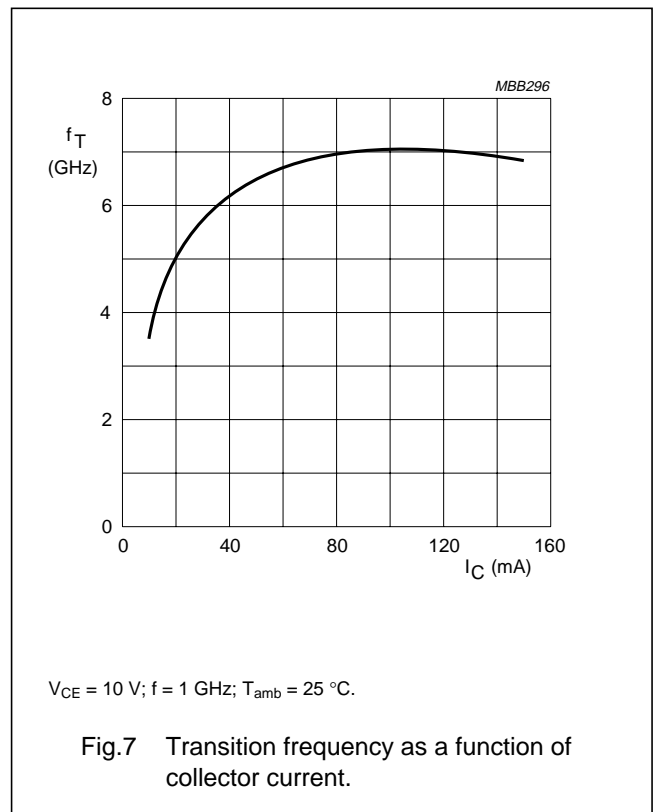
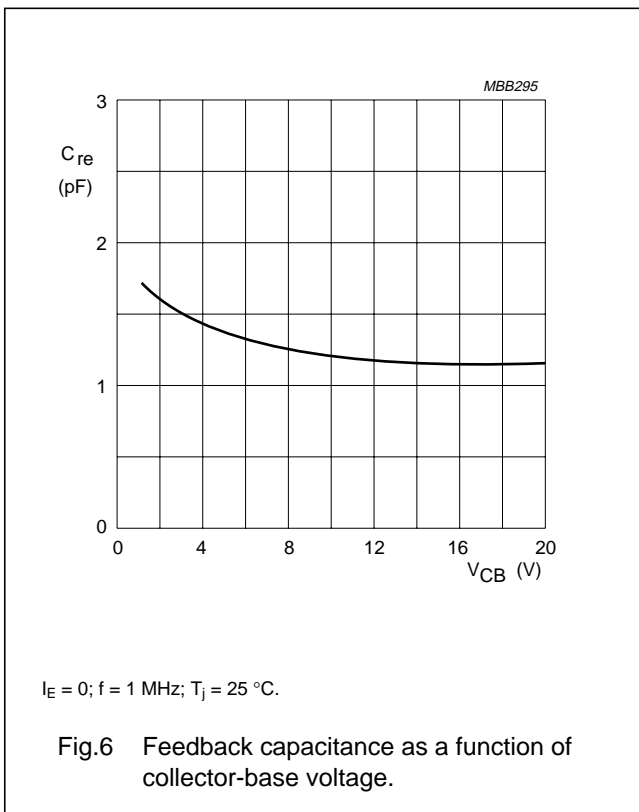
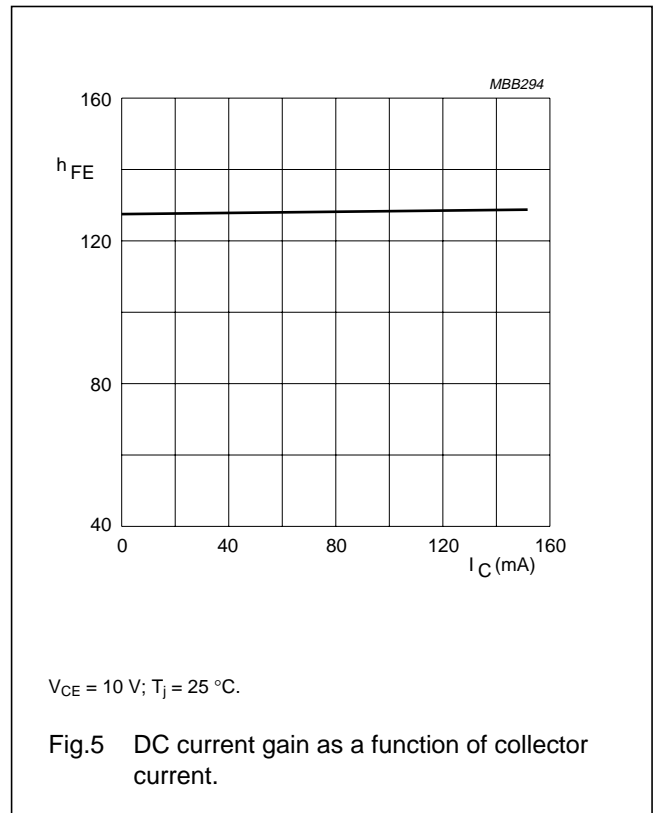
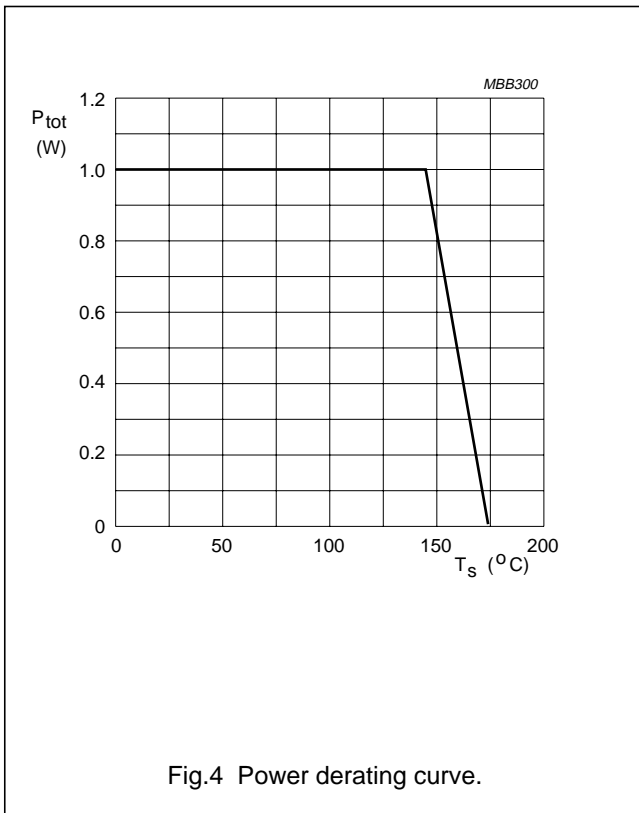

Fig.3 Intermodulation distortion test printed-circuit board.

NPN 7GHz wideband transistor

BFG135



NPN 7GHz wideband transistor

BFG135

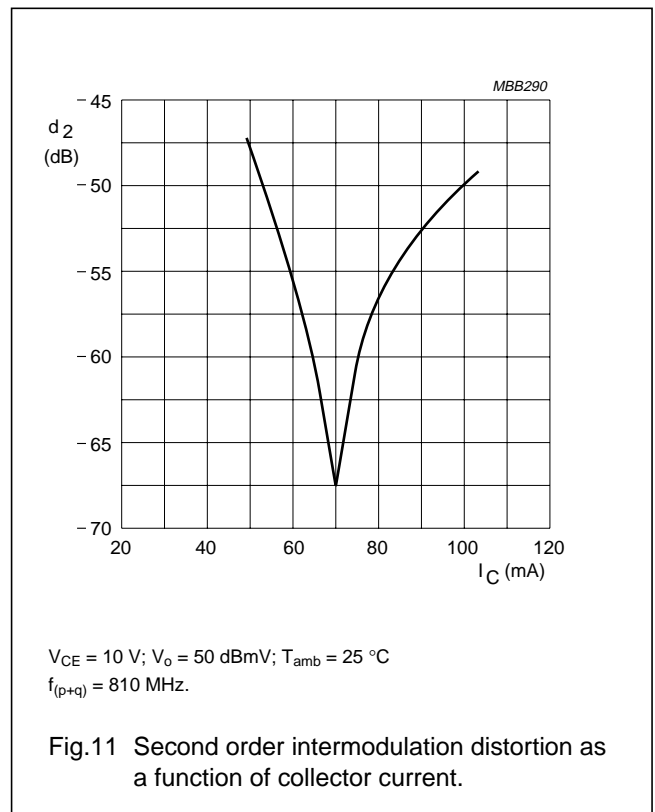
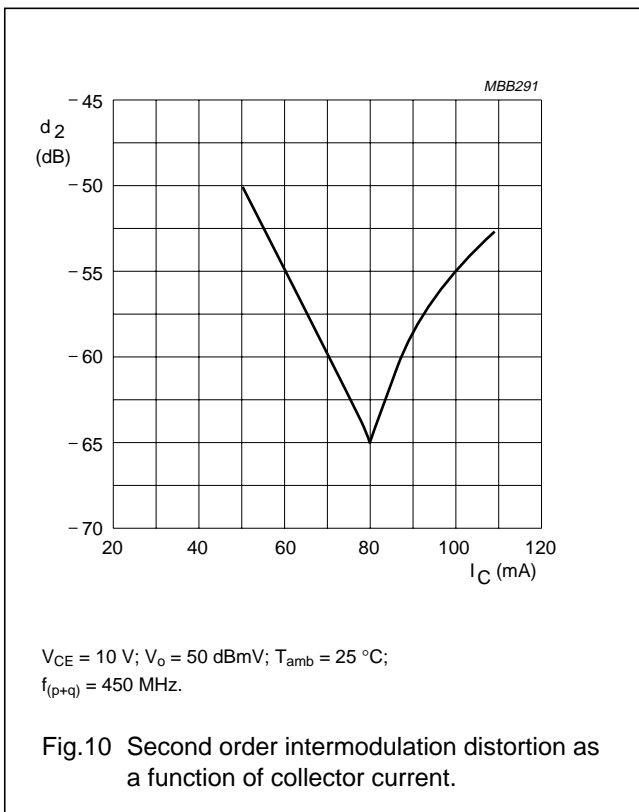
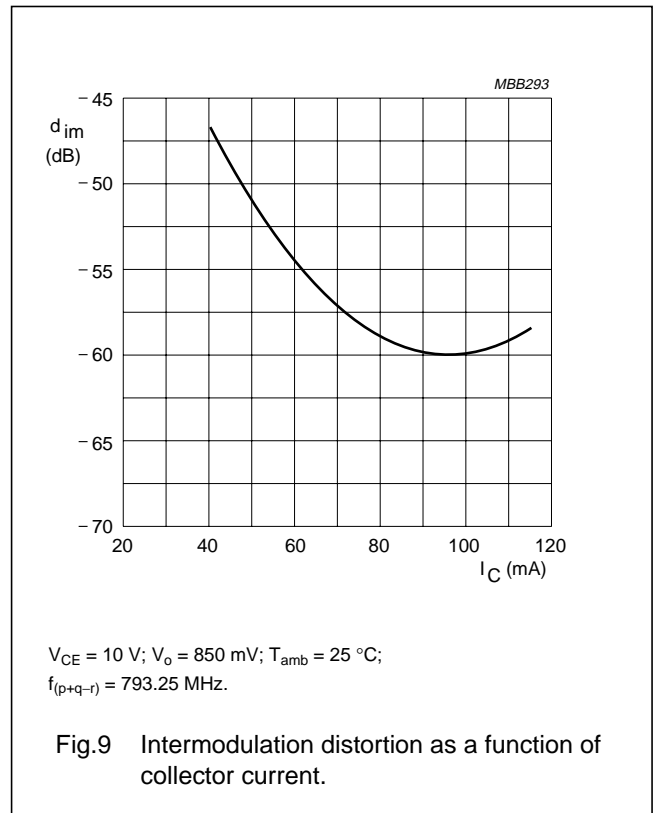
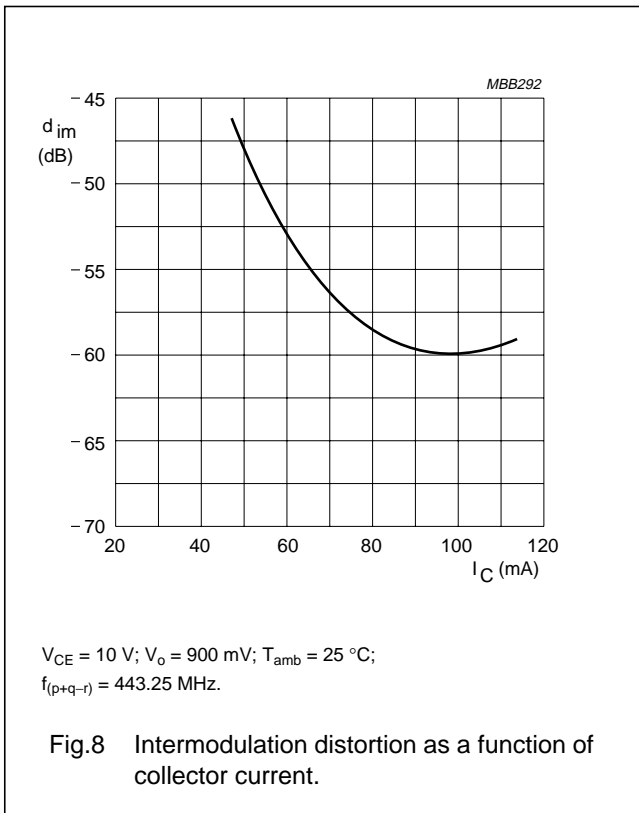

NPN 7GHz wideband transistor

BFG135

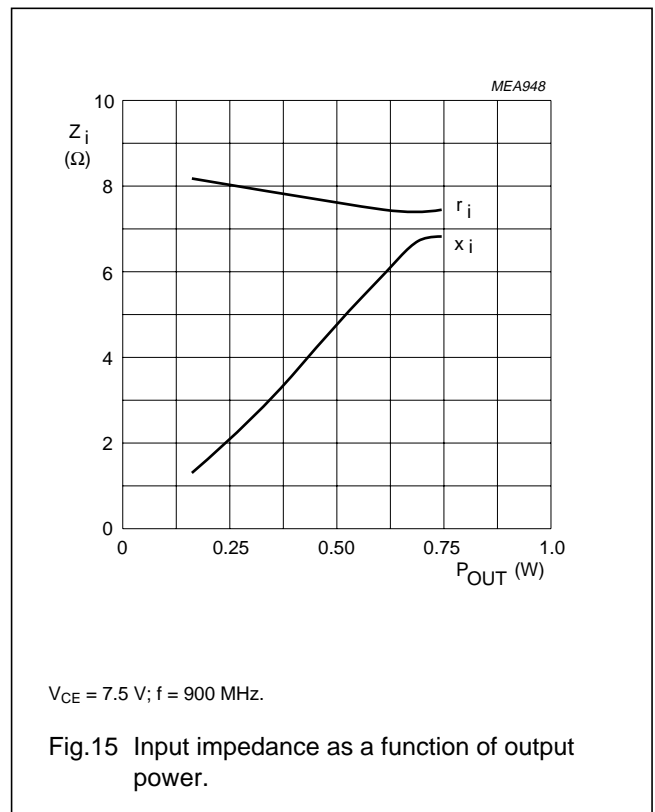
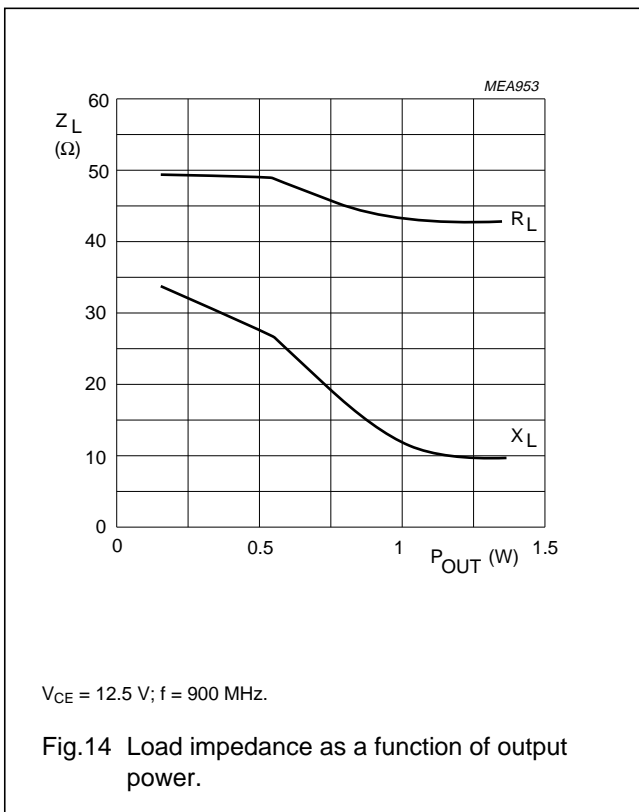
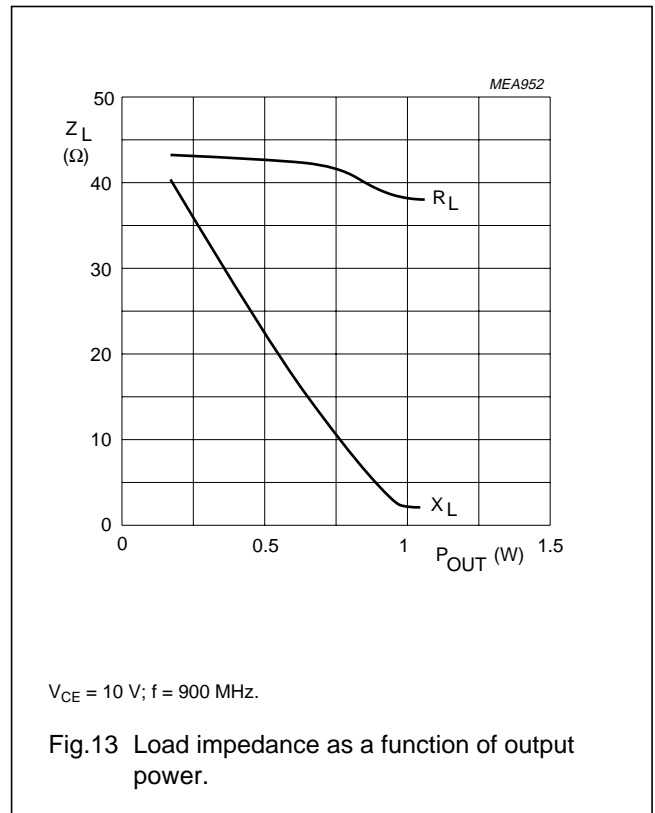
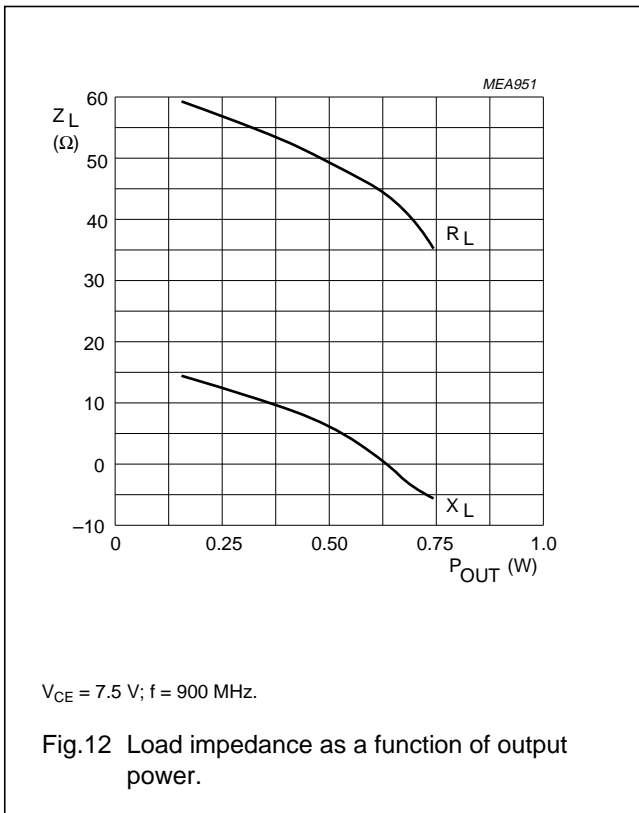



NPN 7GHz wideband transistor

BFG135

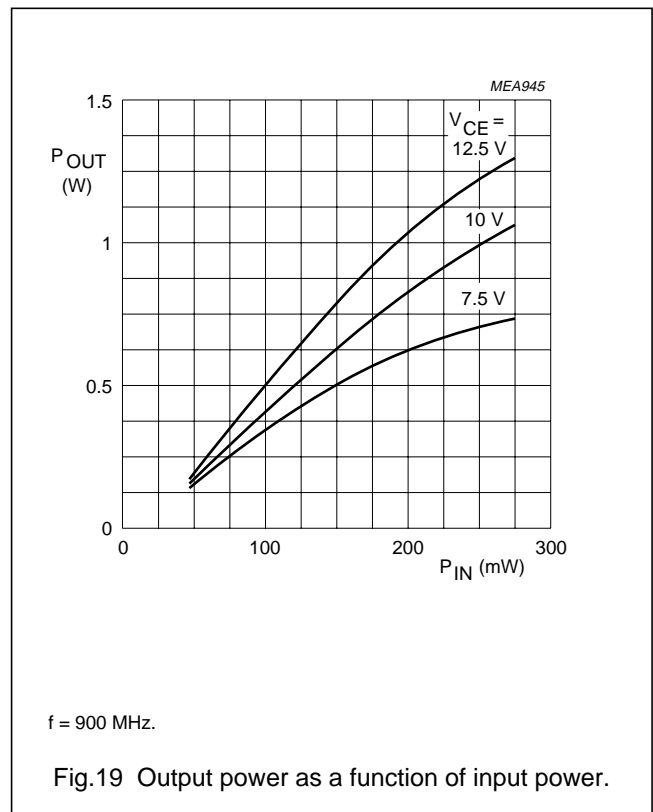
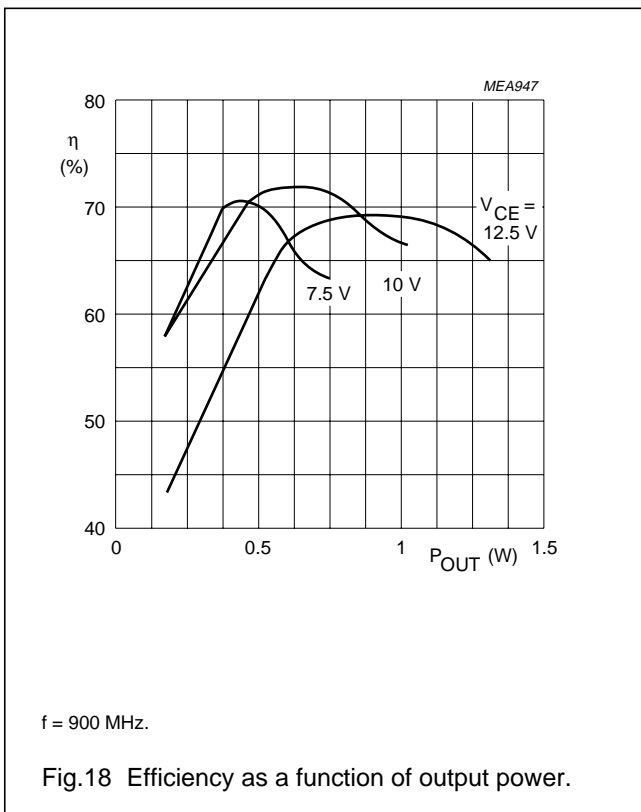
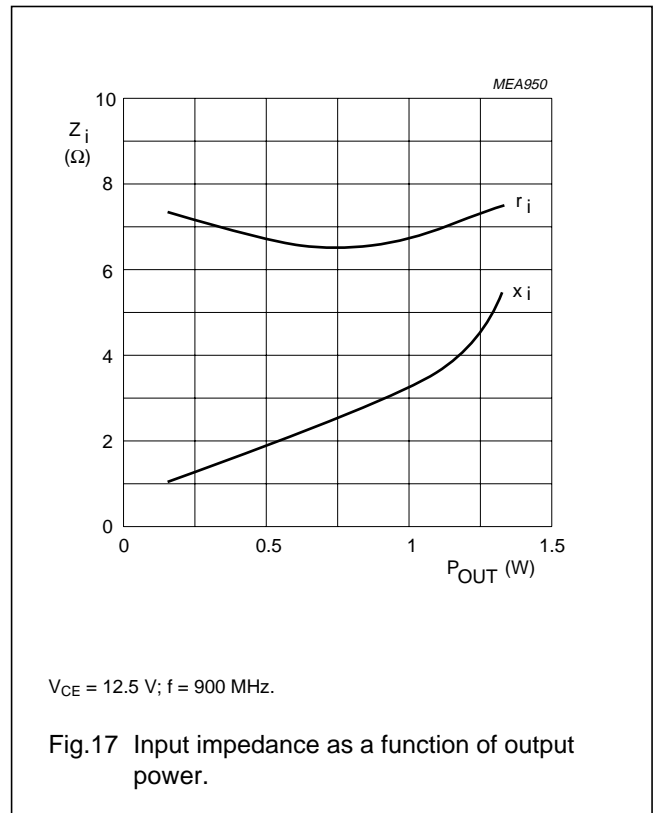
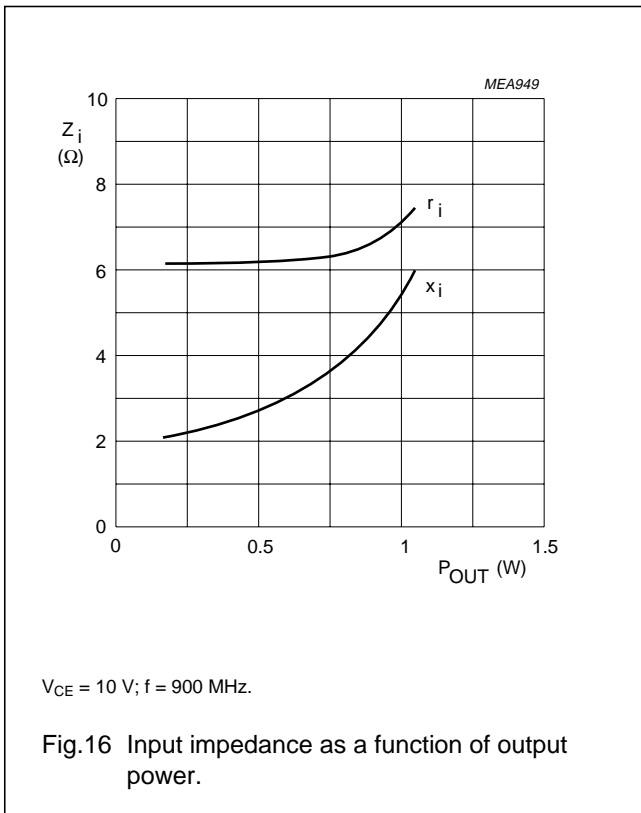

NPN 7GHz wideband transistor

BFG135

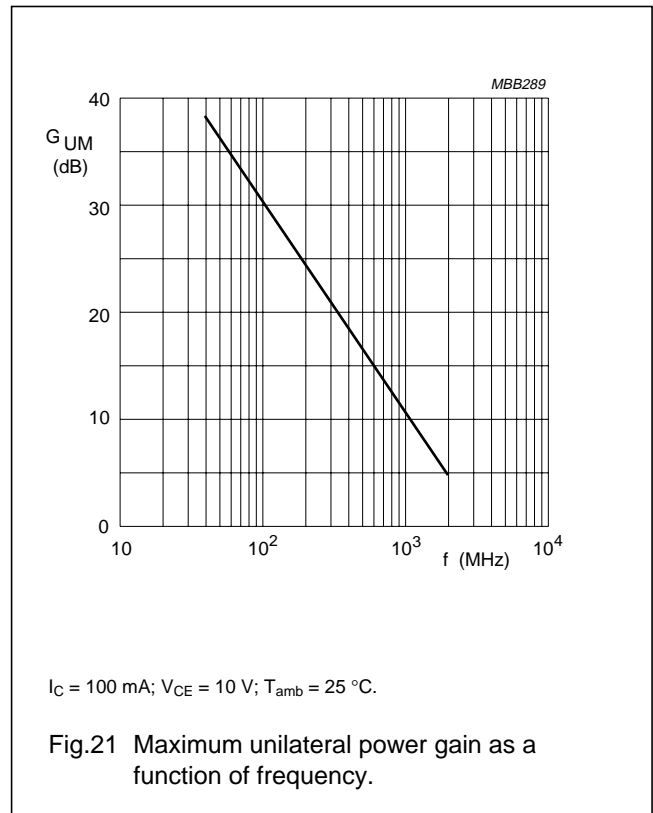
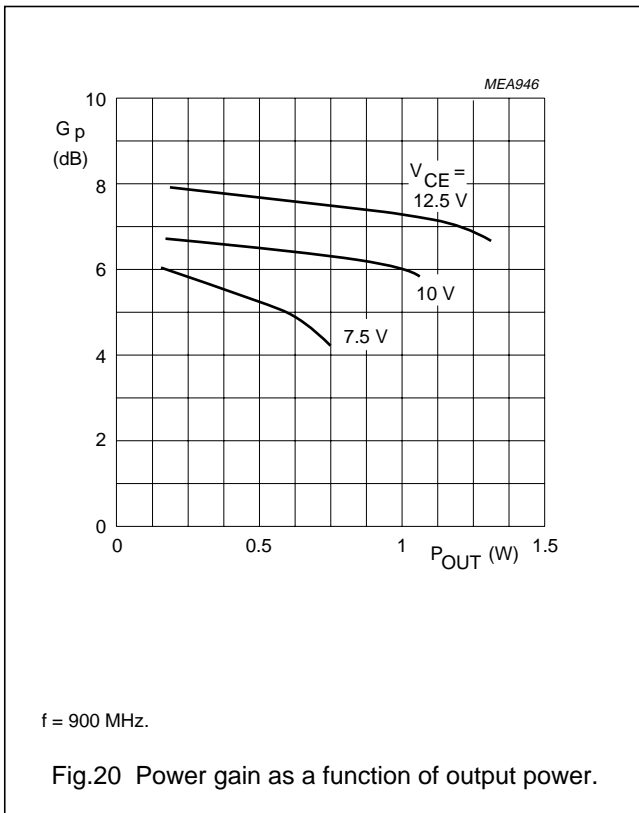

NPN 7GHz wideband transistor

BFG135

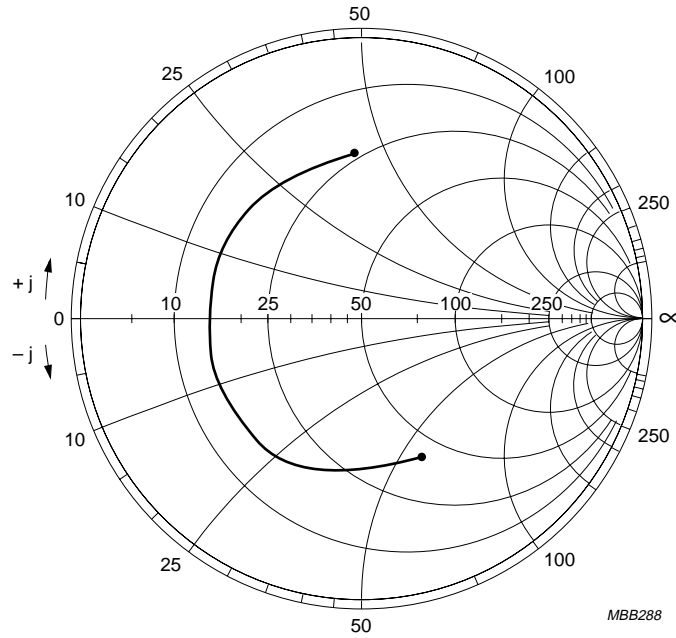

$I_C = 100 \text{ mA}; V_{CE} = 10 \text{ V}; T_{amb} = 25 \text{ }^\circ\text{C}; Z_o = 50 \text{ } \Omega$ .

Fig.22 Common emitter input reflection coefficient ( $S_{11}$ ).

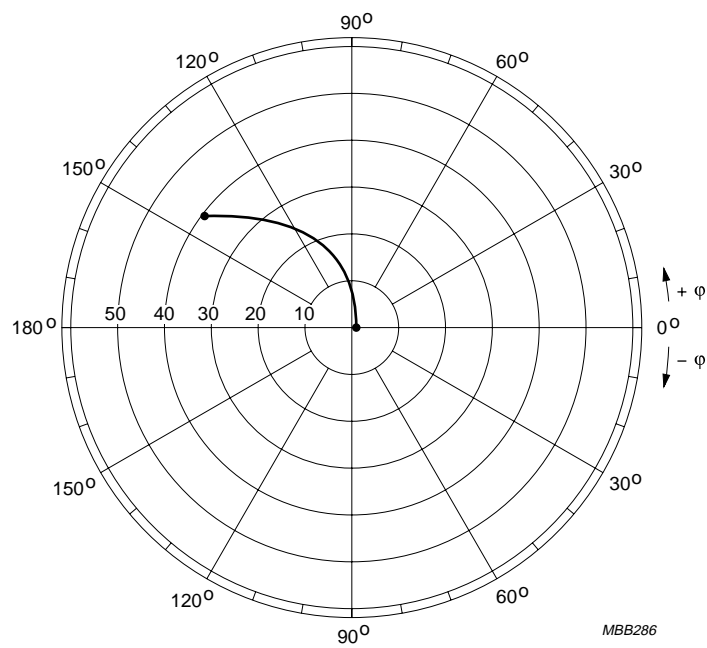

$I_C = 100 \text{ mA}; V_{CE} = 10 \text{ V}; T_{amb} = 25 \text{ }^\circ\text{C}$ .

Fig.23 Common emitter forward transmission coefficient ( $S_{21}$ ).

NPN 7GHz wideband transistor

BFG135

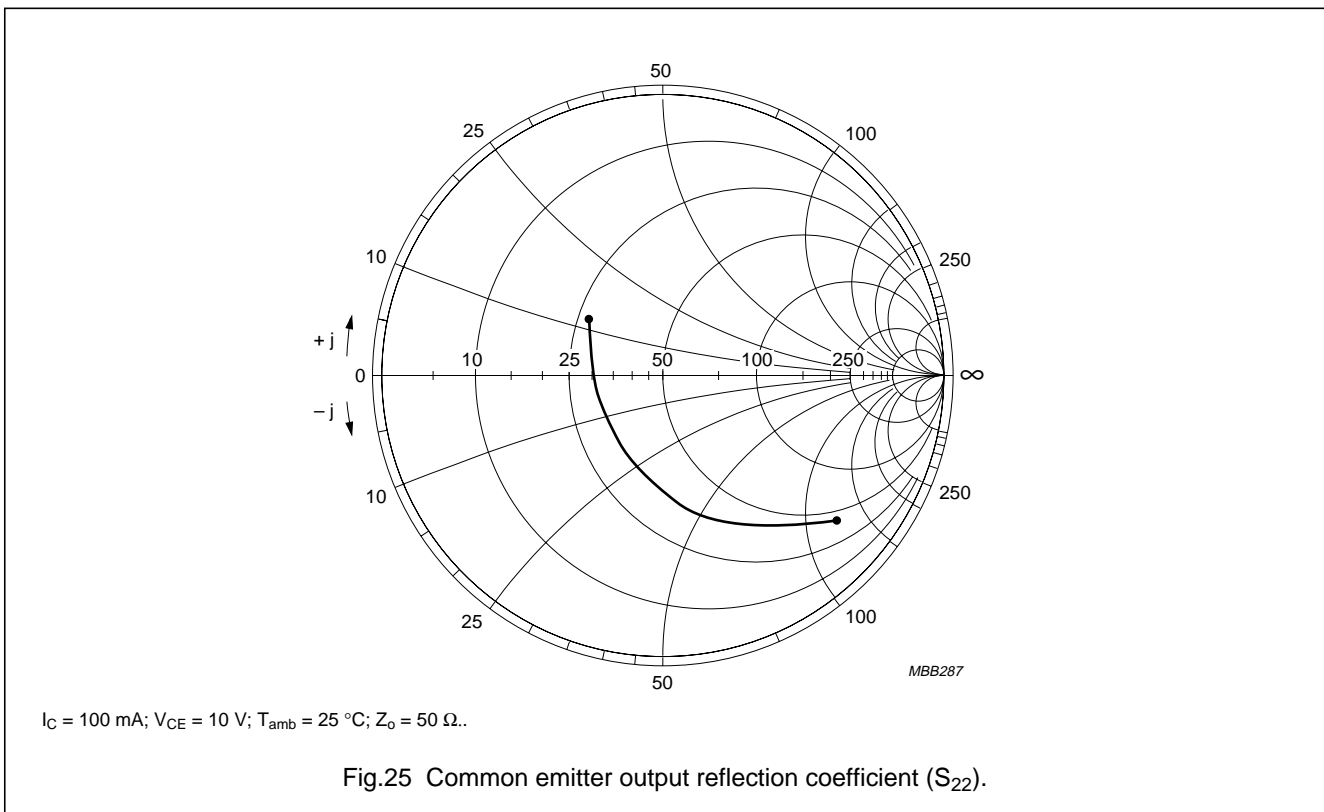
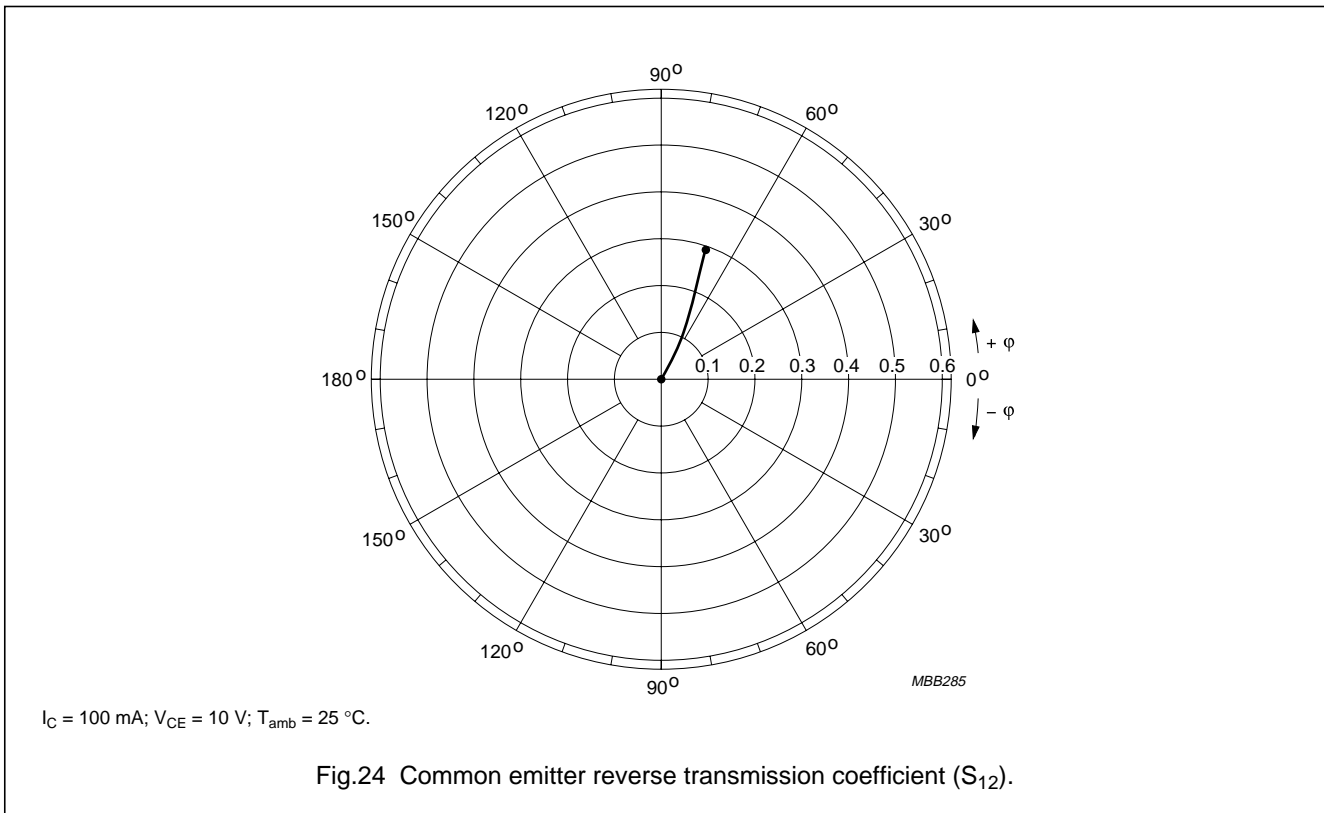

This datasheet has been download from:

[www.datasheetcatalog.com](http://www.datasheetcatalog.com)

Datasheets for electronics components.