

MintyBoost! - Small battery-powered USB charger

by [ladyada](#) on May 30, 2006

Table of Contents

intro: MintyBoost! - Small battery-powered USB charger	2
step 1: The Process (Meta documentation)	2
File Downloads	2
step 2: The Process: Come up with an idea	2
step 3: The Process: Engineering a better solution	3
step 4: The Process: Enclosure selection	3
step 5: The Process: Boost chip selection	5
step 6: The Process: Inductor selection	6
step 7: The Process: Rapid Prototyping	6
step 8: The Process: Prototype testing	9
step 9: The Process: Kit budgeting	12
step 10: The Process: Finishing up!	13
step 11: Make: Tools	15
step 12: Make: Parts	15
step 13: Make: Place diode and electrolytics	16
step 14: Make: Solder	16
step 15: Make: Clip	17
step 16: Make: Place ceramic capacitors, inductor & jack	17
step 17: Make: Clip 2	19
step 18: Make: Final soldering	19
step 19: Make: Done!	20
step 20: Test: Make sure it works	20
step 21: Case: Mintification	21
step 22: Case: Cut	22
step 23: Case: Bend	22
step 24: Case: Test fit	23
step 25: Case: Final fit	23
step 26: Done!	24
Related Instructables	25
Advertisements	25
Customized Instructable T-shirts	25
Comments	25

intro: MintyBoost! - Small battery-powered USB charger

This project details a small & simple, but very powerful USB charger for your mp3 player, camera, cell phone, and any other gadget you can plug into a USB port to charge!

The charger circuitry and 2 AA batteries fit into an Altoids gum tin, and will run your iPod for hours: 2.5x more than you'd get from a 9V USB charger! You can use rechargeable batteries too.

Some numbers...

iPod video (tested, using alkaline batteries): 3hrs more video (1 full recharge)

iPod mini (tested w/rechargeables): 25 hours more (1.5 full recharges)

iPod shuffle (unverified): 60 hours more (5 full recharges)

Weight (with 2xAA): 3.5oz

This project is suitable for beginners, some soldering tools are necessary but even if you've never soldered before it should be pretty easy. You can etch a circuitboard and/or breadboard this up, or simply [buy the kit from the adafruit webshop](#).

I've also documented the process of designing this kit, in case other people interested in designing and making kits are interested in learning how to start selling their own kits!

This project was developed under support from [EYEBEAM](#), thanks!

- NOTICE!!!
 - This instructions are outdated, some
 - minor changes have been made to
 - the kit to make it better. If you're building
 - a purchased kit please read the docs at:
 - <http://www.adafruit.com/make/mintyboost>
 - THANKS!!!! - ladyada
- Image Notes1. High efficiency boost converter2. Plug in anything that charges over USB!3. Uses 2 AA batteries, rechargeable or alkaline

step 1: The Process (Meta documentation)

This next 10 steps detail how I went through the process of coming up with the idea, hardware, design, etc. for this project. It's not 100% correct but it's pretty close. Since this project only took 2 days (on & off) to design/test/release, it's a lot easier to keep track of than something enormous like the x0xb0x.

I also include the schematic/layout files in Eagle format. The prototype one is best for etching at home (its single sided)

File Downloads



5Vboostproto.sch (163 KB)

[NOTE: When saving, if you see .tmp as the file ext, rename it to '5Vboostproto.sch']



5Vboostproto.brd (9 KB)

[NOTE: When saving, if you see .tmp as the file ext, rename it to '5Vboostproto.brd']



5Vboostlbi.sch (221 KB)

[NOTE: When saving, if you see .tmp as the file ext, rename it to '5Vboostlbi.sch']



5Vboostlbi.brd (13 KB)

[NOTE: When saving, if you see .tmp as the file ext, rename it to '5Vboostlbi.brd']

step 2: The Process: Come up with an idea

OK so where does an idea come from anyways? Its the only important question & the most difficult. I guess I'd have to say it was prompted by looking at these half-dozen projects:

Aaron Dunlaps* [9V USB charger](#)

Another [9V + 7805 USB charger](#) (Instructables)

Jason Streigel's [9V+7805 USB 'battery'](#) (hackaday)

Ians [Firewire switching charger](#) (Instructables)

Chris DiClerico's [9V+AA's firewire charger](#)

OK, there's probably even some I'm missing. So what's the overarching theme here? Almost all use 9V batteries and a 7805 (an extremely common linear 5V regulator: makes a solid 5V from 7-18V input). This design works great because, well, 7805's are awesome and 9V's provide 7-9V depending upon how 'dead' they are.

However, there's one thing about 9V's that I've learned (from lots of bad experiences). One is that they don't have a lot of amp-hours: that is, how much current (amps) they can provide and for how long (hours). A duracell 9V provides -about- 500mAh over its lifetime. That's 500 mA (or .5A) for one hour or 100mA for 5 hours. That number is somewhat idealized but its a good starting point.

Another problem is that they don't like to supply a lot of current, because they have high internal resistance (~2ohms), but basically that just means that if you want a lot of current (say to resuscitate a drained device) the 9V wont provide all 500mAh, but maybe more like 400. (Say you're drawing 250mA, then $.25A * 2ohm = 0.5V$ lost to internal resistance. For more info on 9V, read the [duracell datasheet](#))

Another problem with the 9V+7805 scheme is that a 7805 is a linear regulator. That means if you want 100mA at 5V (basically, USB power) then you're taking 100mA at 9V and then losing the $4V * 100mA = 400mW$ (.4W) difference as heat.

As the battery wears down to 7V the heat loss goes down to $(7-5V) * 100mA = .2W$ but you're still getting bad efficiency. At best the efficiency is 72% (5V/7V) and at worst its 55% (5V/9V) That means you're losing about a third of the battery power to heat!

<http://www.instructables.com/id/MintyBoost!---Small-battery-powered-USB-charger/>

I'll also throw out that the 7805 itself has a quiescent current of about 5mA so you're always losing 5% (5mA/100mA) efficiency just for regulation! (& that's **at least** since if you're trickle charging the battery at 50mA then the 5mA quiescent is 10%)

OK so basically the 7805+9V solution works but the efficiency is startlingly low, say 60% or so, and provides only 300mAh at 5V.

We can engineer better!



step 3: The Process: Engineering a better solution

From experience, I know that AA's are great. They are cheap, have lots of power, very low internal resistance and are easily available everywhere. Whereas a 9V has 500mAh (for a total of $9 \times 500 = 4.5\text{Wh}$ power) two AA's have 3000mAh each for a total of $2 \times 1.5\text{V} \times 3000\text{mAh} = 9\text{Wh}$, about twice as much power. The only problem is that 2x AA's provide 3V and what we need is 5V. With a 9V battery we can use a linear regulator because $5\text{V} < 9\text{V}$ but, sadly, we can't use a linear regulator to turn 3V into 5V. Instead we will need to use a boost regulator (also known as a DC/DC switching/step-up regulator)

The process of how a boost regulator works is somewhat beyond the scope of this document, suffice to say they work great but are a little more annoying than linear regulators because you have to pick out an inductor and wire up some extra parts. You can get a lot more info about Boost Converters at wikipedia which is also where I stole the boost topology image from.

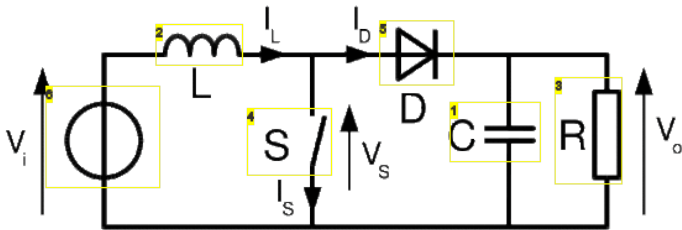

Image Notes

1. Output capacitor (smooths out the output voltage)
2. INductor
3. Output load...you know, like an iPod :)
4. Switch (hence "switching" power supply) This is actually a transistor, and the switching part is controlled by internal chip logic
5. Switching diode (schottky)
6. Input power (batteries, in our case)

step 4: The Process: Enclosure selection

So at this point I start thinking about enclosure and size. Most people think of this last, and that's a bad idea. If there's one thing I've learned from hacking on electronics, it's that you should try and select the case first because it dictates a lot of the electronics and interface.

I know that the parts for the kit must be all through-hole (no surface mount) and easy to work with. I also want AA batteries, 2 is good although I know from experience that most boost converters will work with any number from 1 and 3 just fine. I have a predilection for Altoids tins and I also know that I can fit ~2 AA's into a gum tin so I pull out a tin and take some measurements.

OK 2 AA's fit well, so now I rummage through my collection of battery holders and find one (PCB-mount) which seems to be pretty good, it doesn't have a switch but I don't need one anyway (see quiescent calculations, later on)

So I take some measurements...Looks like I have about 1.25" x 0.7" semicircular PCB space at the top for the circuit board.

I also try out another battery holder I have, this gives me more space, 1.25"x0.85"...but the batteries go in sideways so one would have to remove the holder to change the batteries. I'd prefer that you can just take them out directly, so I don't go with this one (it also turns out I don't need that extra space)

(I now do a little hack to turn the PCB mount 2x AA battery holder into a wire-lead one. Basically I just solder on red and black 6" wires and clip off the PCB through-hole leads. This is actually a little difficult because the plastic melts and you have to sort of keep it in place while you solder. Its not suggested :))

Now that's done I'm ready to think about what I can cram into that space.



Image Notes

1. Expensive...but worth it!

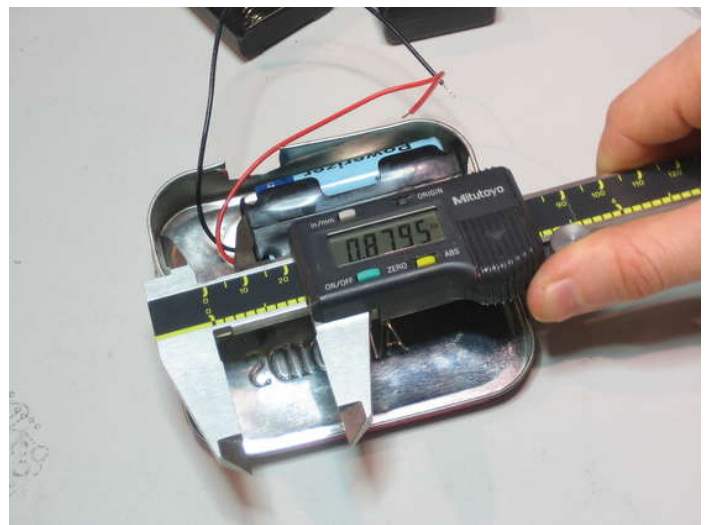

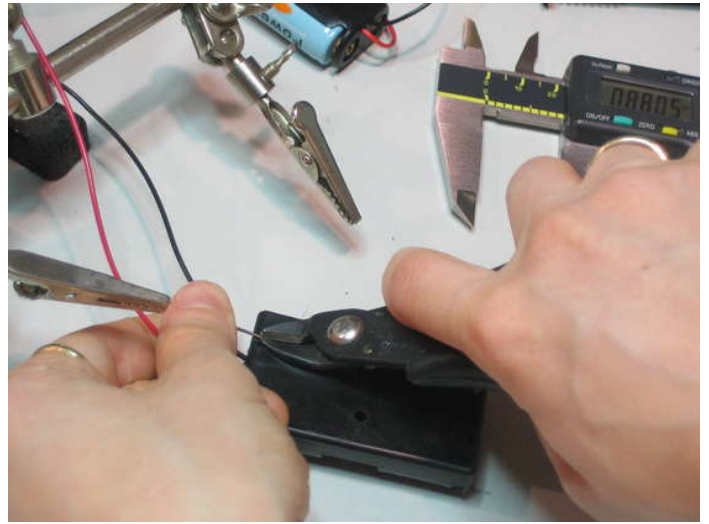
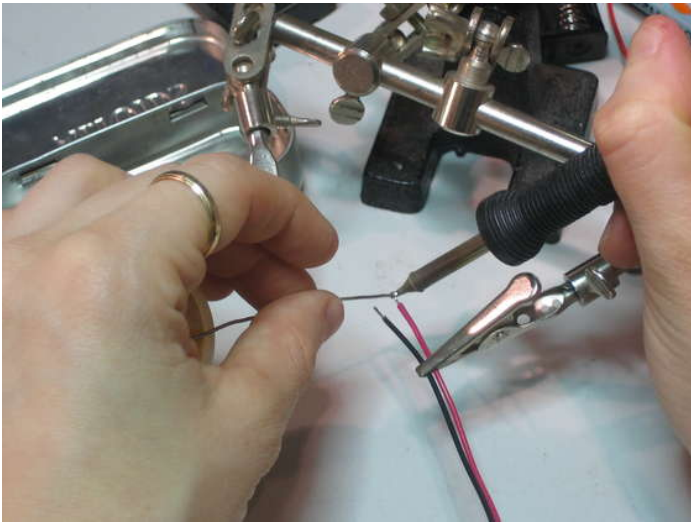

step 5: The Process: Boost chip selection

So now it's time to design the boost supply. Since I don't have much space, I'm going to try to make my circuit as tiny as possible but still be easy to solder. That means I want a boost chip that is 8-DIP (smallest through-hole), with an internal MOSFET switch (1 less part) and is high frequency (to keep the inductor small). I also need to be able to supply 100mA at 5V and it should run on as low as 2V input. Also I want to be able to buy it online from a common supplier.

- 8-DIP package
- Internal FET switch
- 100mA output @ 5V
- 2V minimum input voltage

OK, let's search Digikey. I start with "DC/DC converter 8-DIP" and check "items in stock"

I then select 1 output, 8-DIP (to differentiate between 18-DIP) and select all the current-outputs $\geq 100\text{mA}$ and apply the filter. There's still about 40 options. So then I select the all voltage input ranges that start with 2V or less. Also I select all the Adjustable, and 5V-inclusive output voltage options

Looking over this list, it looks like I have a lot of options so I'm going to go back and select only the chips that can be preset to 5V (as opposed to adjustable ones that use 2 resistors to set the voltage). 5V is very common so every reasonable DC/DC chip will be available with such an option.

Now there are about a dozen options. The LT1073, LT1111, LT1173 and LT130x as well as the MAX751 & MAX756. They're all pretty much the same, so I basically make my choice based on price at 100 pieces (since I'm planning to kit it up). I also know that Maxim is great about sending samples so I decide to go with the MAX756 datasheet() which is \$2.32/100. Note that I could have gone with any of them, so this is a somewhat arbitrary choice.

According to the datasheet, I can supply up to 200mA @ 5V, run off input voltages as low as 0.7V and the efficiency is about 85% with 2 AA batteries. The chip also runs at 500kHz which is pretty fast and means that the inductor can be pretty small (~22uH) Anyway, I've used this chip before and it's worked out well for me.

Voltage-Input

- 1.2V-5.5V
- 1.5V-5.5V
- 1.7V-16.5V
- 1.8V-10V
- 2V-10V
- 2V-16.5V
- 2V-3.6V
- 2V-30V
- 2V-9V
- 2.4V-5.5V

Voltage-Output

- Adjustable
- Adjustable Negative Output
- 1.25V-38V
- 2V-16.5V
- 3.3V, 5V
- 4.8V-5.2V
- 5V
- 5V, 12V
- 5V-16.5V
- 12V

Keywords: DC/DC converter 8-DIP

Items in Stock
 Lead Free
 RoHS Compliant

Search Again [Advanced](#)

Integrated Circuits (IC's) | DC/DC Converters & Controllers (DC-DC)

Current Output	Features	Number of Outputs	Output Power	Package / Case
0.025mA	CMOS	1	300mW	8-DIP
10mA	Cycle-by-Cycle Current Limiting, Overcurrent, Soft-Start & Undervoltage Protection	2	500mW	10-DIP
20mA	Generates Positive & Negative Doubled Outputs Simultaneously		550mW	18-DIP
30mA	High Efficiency		700mW	
40mA	High Efficiency at Low-input Voltages		727mW	
50mA	High Efficiency, Burst ModeTM & Current Mode Operation		730mW	
80mA	High Efficiency, Burst ModeTM Operation		1W	
100mA	High Efficiency, Internal Power Switches, Shutdown & Low Battery Detector		1.175W	
120mA			1.25W	
150mA				
200mA				

Reset | [Apply Filters](#)

step 6: The Process: Inductor selection

The next step is to choose an inductor. This can be a bit of a pain, and there is a lot of math you can throw at the problem. However, the datasheet suggests (under "inductor selection") to get a 22uH inductor, with a ~1.2A saturation limit, and DC resistance of 0.02 ohms.

What we want is through-hole, which actually means its going to be hard to find an inductor; almost all inductors are surface mount. But I'll take a look at what digikey has to offer. I search for "fixed uH inductor ~smd ~smt" which means I **don't** want SMT/SMD (surface mount) and I want a non-adjustable inductor that is in the uH range (not mH or nH). I then filter out inductors with 1-3A current and 18-27uH inductance.

That filters it down to about a dozen choices. The SLF inductor is actually surface mount, and we're going to outright ignore the ones that cost more than \$2.50. Inductors for small electronics like this should cost around \$1-\$2, as a guideline. That leaves us with the DN7418-ND "INDUCTOR 27UH POWER AXIAL" and the 6000-220K-RC "INDUCTOR HI CURRENT RADIAL 22UH." Both of these look good, with about ~1.5A saturation current and 0.07 ohm DC resistance.

I also check out Mouser. The online search for mouser isn't as nice as Digikey's so I end up looking at the paper catalog instead. I only found one inductor, really, the 18R223C (22uH radial power inductor) and/or the 18223C (axial version) that also has plenty of power capacity and a 0.03ohm DC resistance.

So, order 2 of each of these.

Keywords: fixed uH inductor ~smt ~smd

Items in Stock
 Lead Free
 RoHS Compliant

Search Again [Advanced](#)

Excl: 24216
 uH: 23254
 inductor: 24513
 Excluding "smt": 97744
 Excluding "smd": 156620
 Records matching criteria: 2238

Inductors/Coils/Chokes **Fixed**

Current	Inductance	Package / Case	Packaging	Series
2.65A	16.76uH	Axial	Bulk	B82422A
2.7A	18uH	PCB Mount	Out Tape (CT)	B82422H
2.75A	18.64uH	Radial	Tape & Reel (TR)	B82422T
2.8A	18.85uH	Radial - Horizontal Mount		B82432C
2.84A	20uH	Radial - Vertical Mount		B82432T
2.9A	21.65uH	Through Hole		B82442A
2.97A	22uH	2.5mm x 2mm x 1.8mm		B82442H
3A	24.31uH	6mm x 6mm x 2.8mm		QM1011
3.09A	25uH	6.3mm x 6mm x 2.5mm		CM9900
3.1A	27uH			

Reset | [Apply Filters](#)

step 7: The Process: Rapid Prototyping

In reality, what I did was look through the Digikey catalog, where I only found the DN7418 inductor (the other one was somewhat hidden in the RF inductor section). And it showed up before the Mouser box, so I spent an hour or two making up a prototype.

The circuit itself is simple, I want one large electrolytic cap for low frequency smoothing on the battery, and an output cap pair (electrolytic and one ceramic cap for high freq. smoothing). I also need the chip, a reference voltage capacitor, the inductor and a schottky diode to finish off the boost regulator. I happen to have some 1N5818's, which are often used as schottky diodes in boost regulators. I also need a USB type A female jack, of course, and two holes to solder the battery pack into. You can compare the schematic to the topology diagram in step #3 keeping in mind that this chip has an internal transistor switch.

All these parts must fit into the space left over from the battery pack. I make EagleCAD library parts for the inductor and chip (the rest are already there) and lay out the board. I'm not going to detail making library parts in eagle or pcb layout, others have done so already. Use whichever software you want, I like Eagle because there's a free version available for download if you're just making small PCBs.

Since I am know this is just a prototype version, I make the PCB single sided -- for easy etching. I also make the traces really large. I print out a paper version of the PCB and punch the parts through to verify that they're the right shape/package.

I get my etching setup together, turn on the heater for the etching tank, and print out a bunch of tiled PCB layouts on toner transfer. I transfer the toner onto a single sided PCB and etch it in the tank

Then I clean off the toner transfer, drill the holes with a dremel drill-press with carbide drill bits, and cut out the shape.

Then I solder the parts in, and fit it into the case with the battery pack, using double-sided foam sticky tape to hold down both the battery holder and the PCB without shorting the PCB to the metal tin.

OK, done!

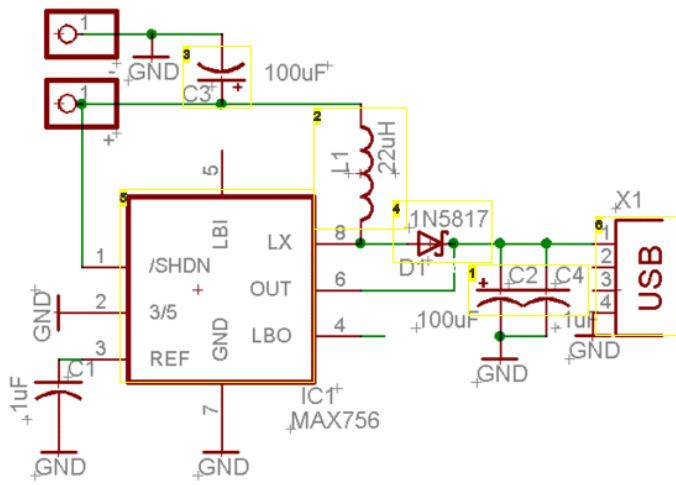

Image Notes

1. Output smoothing capacitors
2. inductor
3. input capacitor
4. Schottky diode
5. DC/DC switching controller (with internal transistor switch)
6. USB jack

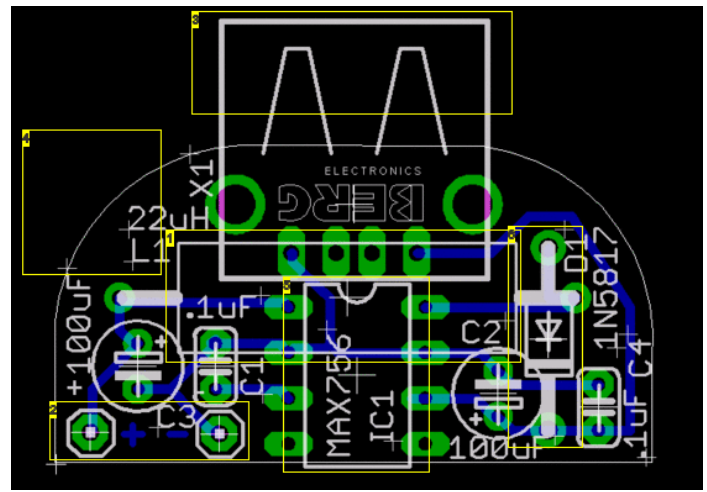

Image Notes

1. Axial inductor goes over the rest of the parts
2. Battery pack connects here
3. Sticks out a bit. Oh well, what can you do?
4. Rounded to fit in tin better
5. Controller chip
6. Diode

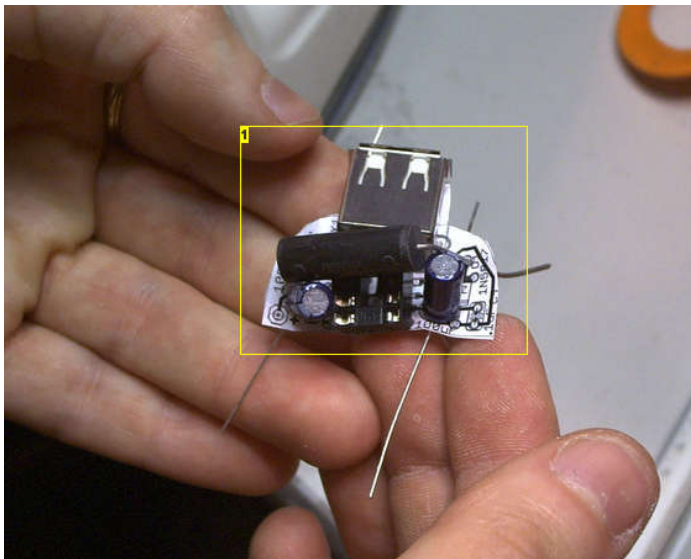
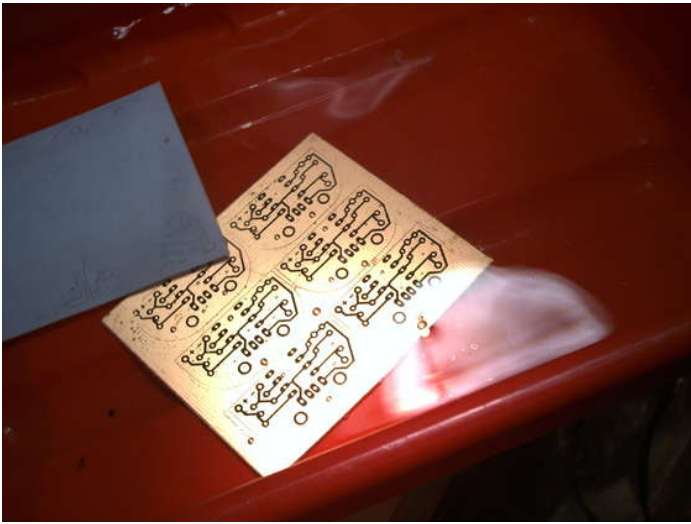
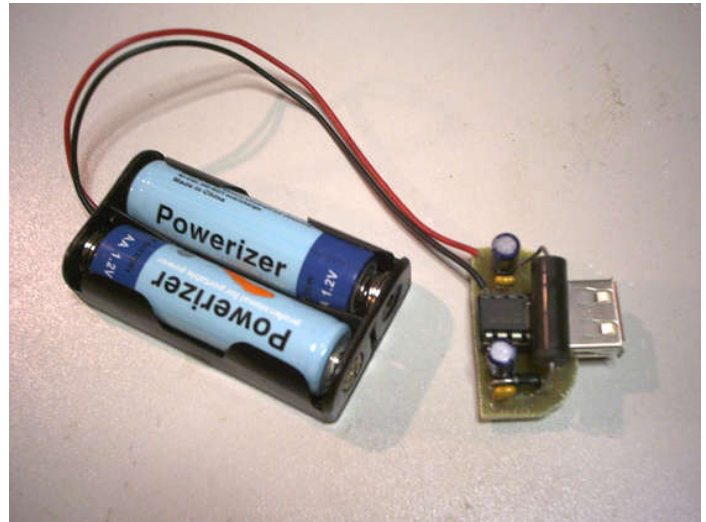

Image Notes

1. Simple 'paper punch' test to verify the parts will fit







step 8: The Process: Prototype testing

Now we test to see if it works! With the two batteries inside, I measure the voltage on the USB connector: about 5V, which is good. I send off this version to a friend with one of each kind of iPod, including the newest 4G video iPod, for real-world testing: Both to verify the iPod will charge and also how long it will run with the additional pack.

Its also time to verify the math for efficiency: how good is it, after all?

So, in theory, we should be able to calculate the efficiency of the boost converter from datasheet info. We're basically boosting 2.5-3VDC -> 5VDC at around 50mA-100mA. Looking at the MAX756 datasheet, note the efficiency graph.

So we should be getting around 85% efficiency, perhaps a little more. I think the only thing that can really change this number a bit is the inductor. (Below, I verify I'm getting 82% efficiency)

If we're getting 82% efficiency conversion from 2 x 3000mAh Duracells, that means we get $(2 * 1.5V) * 3000mAh * .83 = 7.38$ Watt hours. Compare that to a single 9V as we calculated before: $(1 * 9V) * 500mAh * .65 = 2.93$ Wh. So we're going to get about 2.5x more power out of these two AAs than a single 9V.

With rechargeable batteries, we get $(2 * 1.25) * 2200mAh * 81\% = 4.45$ Wh (about 50% more than an alkaline 9V and 3x more than a rechargeable 9V)

Next, lets verify the efficiency using test equipment, and try out the different inductors to see if they make a difference. Instead of using batteries, I'll provide 3V from a bench supply that will also tell me how much current is being drawn. And instead of an iPod I'll fake the load with a resistor. Since the standard USB current draw is 100mA from 5V, that means I need a $5V / .1A = 50$ ohm load. I can't just use a tiny resistor because $5V * .1A = 1/2W$ and most resistors are 1/4W. So instead I take two large 100ohm 'power' resistors, and twist them together. I also check the resistance to verify that together they are 50ohms. I also find a 20ohm power resistor. This will allow me to not only test a 100mA load but also a 250mA load.

I perform 4 tests with 2 inductors: 100mA load for both 2.5V in and 3V in (rechargeable and disposable batteries) and 250 load for both.

My results are summarized in a table attached as the second image

It looks like inductor #2 is little more efficient, probably due to the fact it has a lower DC resistance (30 milliohms instead of 70mohm of the other inductor). It's also a bit cheaper so I'll go with that inductor.

Regardless, it looks like the efficiency is around 82% which is about what I expected.

Another thing to note is that I don't put an on/off switch in like you'd need with a 9V+7805 regulator. That's because the quiescent current of the MAX756 is very low, on the order of 100uA (0.1mA). I measured this myself and got about 75uA.

<http://www.instructables.com/id/MintyBoost!---Small-battery-powered-USB-charger/>

That means that the self-discharge rate is $\sim 2000\text{mAh} / 0.1\text{mA} = 20,000$ hours, more than 2 years. Most batteries don't last that long! Therefore we don't need a switch, when nothing is plugged in, almost no power is being used.

(in the end, i found another radial inductor that was cheaper and as efficient, which is what I use in the kit)

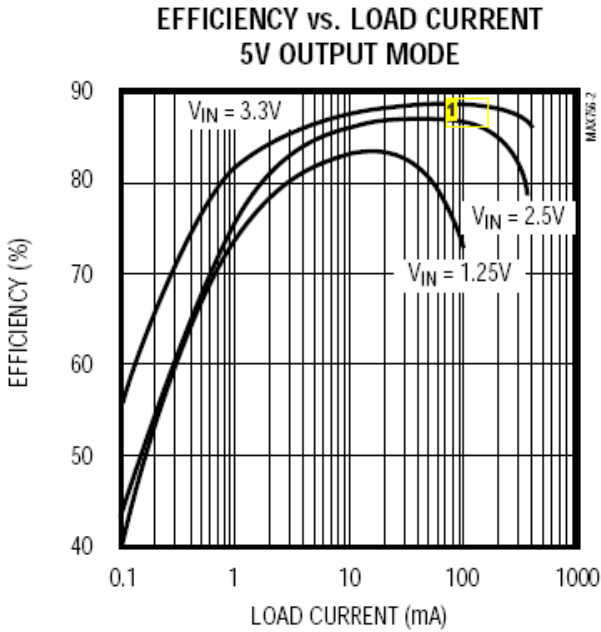

DN2474	100mA/3Vin	100mA/2.5Vin	250mA/3Vin	250mA/2.5Vin
Vout	5.01	4.93	4.77	4.62
Iout (calc'd)	100mA	99mA	234mA	231mA
Iin	200mA	245mA	530mA	690mA
Efficiency	83%	80%	70%	62%

18R223	100mA/3Vin	100mA/2.5Vin	250mA/3Vin	250mA/2.5Vin
Vout	4.98	4.93	4.83	4.68
Iout (calc'd)	100mA	99mA	242mA	234mA
Iin	200mA	240mA	480mA	640mA
Efficiency	83%	81%	82%	68%

Image Notes

1. We're operating around here

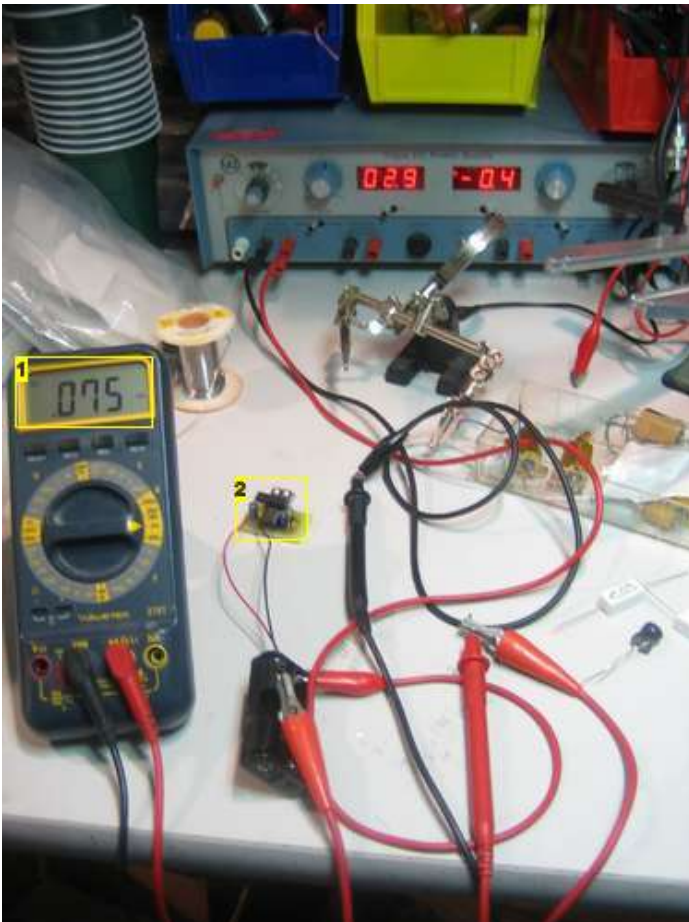

Image Notes

1. Quiescent current is 0.075mA (75uA)
2. Nothing plugged in (testing quiescent current)

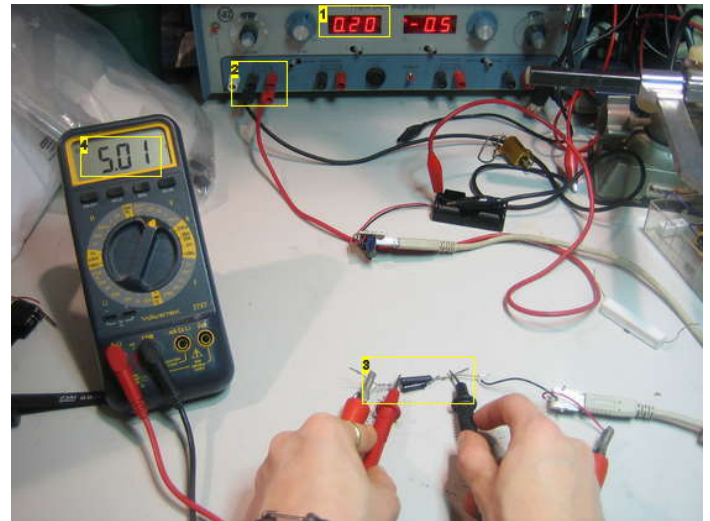

Image Notes

1. 0.2A coming out of the power supply
2. Its supplying 3V, but I decided to show the current draw on the meter...
3. 2 100ohm resistors = 50ohm for 5/50 = 100mA load
4. 5.01V output

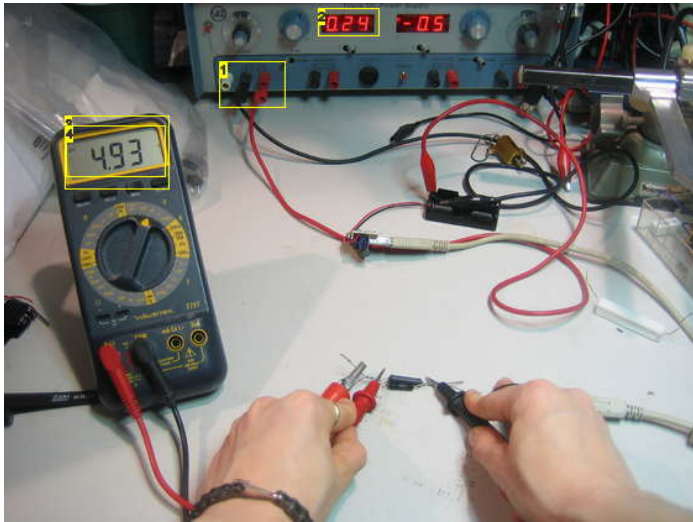

Image Notes

1. 2.5V supplied (2 rechargeables)
2. 0.24A current draw
3. Its harder to step up from 2.5V to 5V than from 3V, so the output sags a little
4. Higher load means the output voltage sags a little

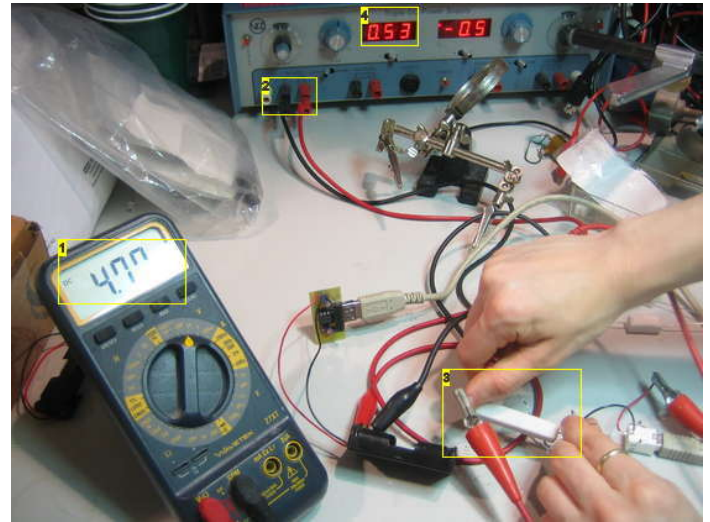

Image Notes

1. 4.77V output, a bigger drop because the load (250mA) is much higher
2. 3V again
3. 20ohm inductor ($5/20 = 250\text{mA}$)
4. 0.53A draw

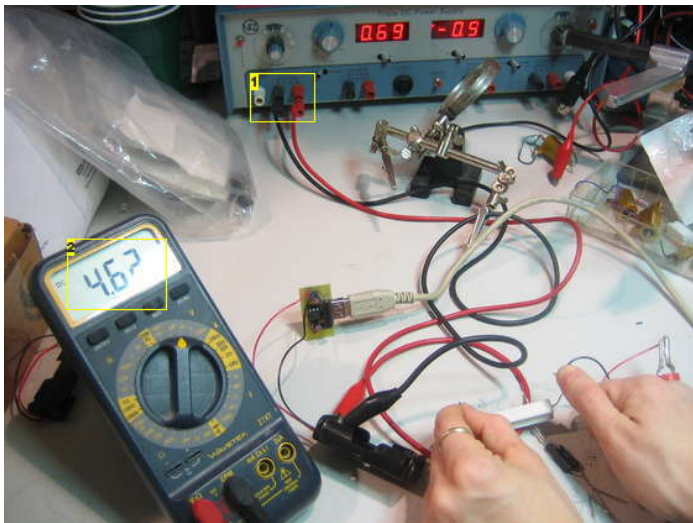

Image Notes

1. 2.5V
2. Even lower, less power and more load!

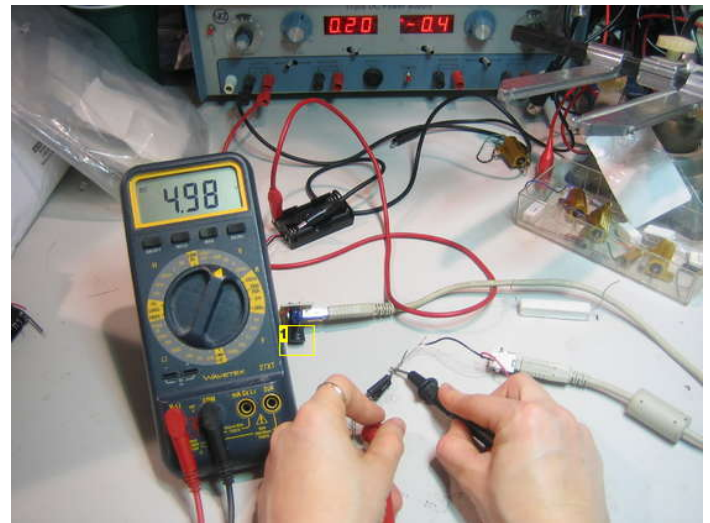
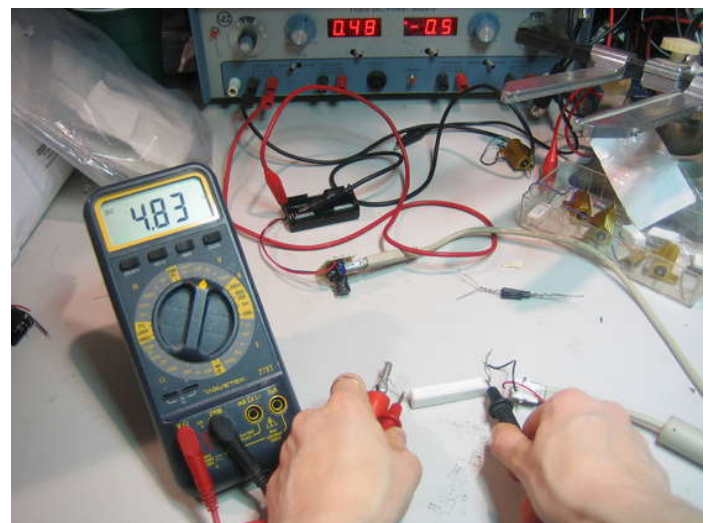
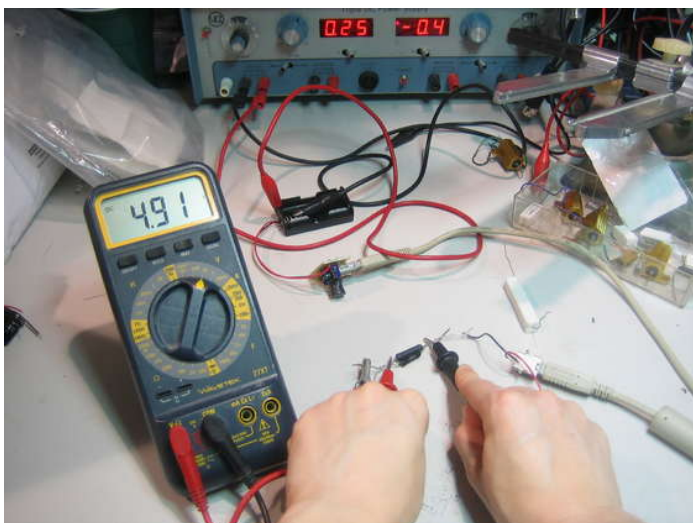
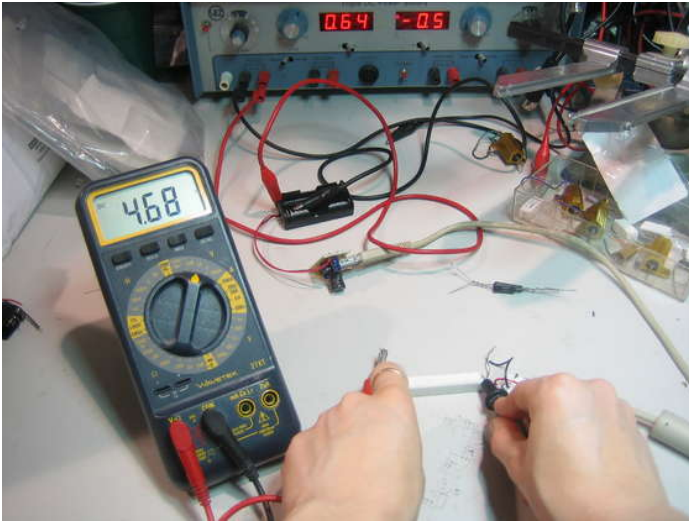

Image Notes

1. Try it again with the radial inductor





step 9: The Process: Kit budgeting

So now that I've verified that the project works, I have to figure out whether I want to sell it, how many I expect to sell, and how much I want to charge. Lots of people have different techniques for this. I tend to go with my 'gut' which usually means there's a lot of information I use but its difficult to express it.

I tend to decide whether I want to sell something based on how popular/useful/easy it is. I think that this kit will be pretty popular and useful because lots of people have stuff that charges/powers over USB. Also, it seems like other people are selling similar things (like the 9V + 7805 type charger, or Griffin's 9V charger, or Belkin's 4xAA charger) It's easy to make because all the parts are through-hole and there's not a lot of them.

I'm going to basically assume I'll sell 200 or so within a few months, and I'll order parts in batches of 100, so I should budget that way. (I often buy more than 100 PCBs at a time because of the scale economies involved in PCB manufacture, as I show later.) It turns out so far that I can sell a couple hundred units of a kit in a few months, particularly if it gets picked up by a blog or web site. This may or may not be true for you, however if you cant afford to make 25 kits at once you're going to find that its hard to make any money in the process.

To figure out how much to charge, I make up a table with different quantity prices

To calculate the PCB costs, I used [Advanced Circuit's](#) insta-quote service.

These prices are for 2 PCBs, which I'll cut in two, because its cheaper (probably because they don't like dealing with very small circuit boards). I usually go with 2 week turn prices. Note that the PCB quote doesn't include the \$150 one-time tooling NRE fee, which adds \$3 to the /50 price and \$1.50 to the /100 price. Advanced Circuits is a little expensive, but they're very good on quality and they're good at catching mistakes. Anyways, you can try going with a cheaper shop but I can only vouch for these guys.

There's also shipping prices included, maybe \$1/per. In general, I double the parts cost to come up with the 'retail' cost. In this case, I'll charge \$19.50. Anything less than \$10 or \$20 is great because \$20 are considered to be stuff/food coupons, really.

Part	Price / 1	Price / 50	Price / 100
Boost chip MAX756	\$4.62	\$2.79	\$2.32
2 x 0.1uF caps	\$0.10	\$0.10	\$0.10
1n5818 diode	\$0.09	\$0.09	\$0.08
2 x 100uF caps	\$0.12	\$0.10	\$0.10
18R223 inductor	\$1.42	\$1.35	\$1.29
USB jack	\$0.52	\$0.35	\$0.32
AA holder	\$0.59	\$0.53	\$0.49
PCB	~\$12.50?	\$7.25	\$3.75
PCB tooling	N/A	\$3	\$1.5
Antistatic Bag	N/A	\$0.12	\$0.12
Sticky tape squares	N/A	\$0.10	\$0.10
Total	\$19.90	\$15.75	\$10.10

Production Price Matrix - Unit Price								
To Place Order: Click on unit price below								
Qty	Same-day	1-day	2-day	3-day	4-day Best Value!	1-week	2-week	4-week
25	\$47.91	\$41.92	\$23.95	\$18.56	\$17.37	\$16.77	\$14.37	\$11.98
50	\$24.76	\$21.66	\$12.38	\$9.59	\$8.97	\$8.66	\$7.43	\$6.19
100	\$13.18	\$11.53	\$6.59	\$5.11	\$4.78	\$4.61	\$3.95	\$3.30
Tooling NRE = \$150.00 (Tooling waived when reordered from proto)						Test = \$140.00 (Optional)		
Production Board Specs								
<ul style="list-style-type: none"> • Layers: 2 • 0.062 FR4 • Dimensions: 1.3" x 1.4" • Plating: Leaded Solder • Cu Weight: 1.oz min • Trace width/spacing: 0.01" • Smallest hole size: 0.024" • Plated Slot: No 			<ul style="list-style-type: none"> • Gold Fingers: None • SMDs-top: 0 • SMDs-bottom: 8 • SMD Pitch: 0.05" • Soldermask: Both Sides with LPI • Soldermask Color: White • Legend: Top Side • Legend Color: Black 			<ul style="list-style-type: none"> • Counter Sinks: No • Counter Bore: No • CNC Route points: 10 • Tab Route: No • Scoring: No • Plated Edges: No • Tolerances • Inspected to IPC-A-600G, Class 2 		

step 10: The Process: Finishing up!

There's a bit more work to do. First, I redesign the board since I'm going with a radial inductor instead of an axial one.

I actually do another etch test, to verify everything one last time. Then I tile two boards together (cheaper) and generate gerbers.

I use gerbv (free software) for viewing and verifying the gerbers. On windows, I use GC-Prevue

I always check the boards with www.freedfm.com before I ship them off to be made. I used 4pcb.com so it's the same company but even if you don't go with 4pcb.com as your PCB manufacturer, it's a neat service.

A week later (depending on your turn time) A box shows up with the circuit boards!

Then I sit in front of a computer and do a lot of website stuff. I also take a lot of photos. A good photo setup will make documentation easy. I have a simple 150W ECT bulb + diffuser setup at EYEBEAM. A tripod is key!

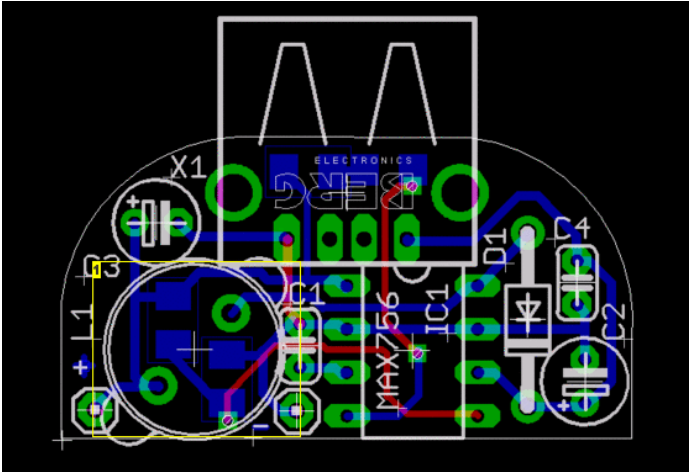

Image Notes

1. Radial inductor

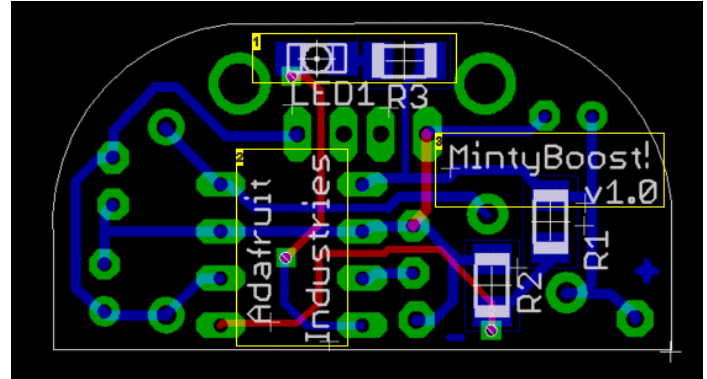
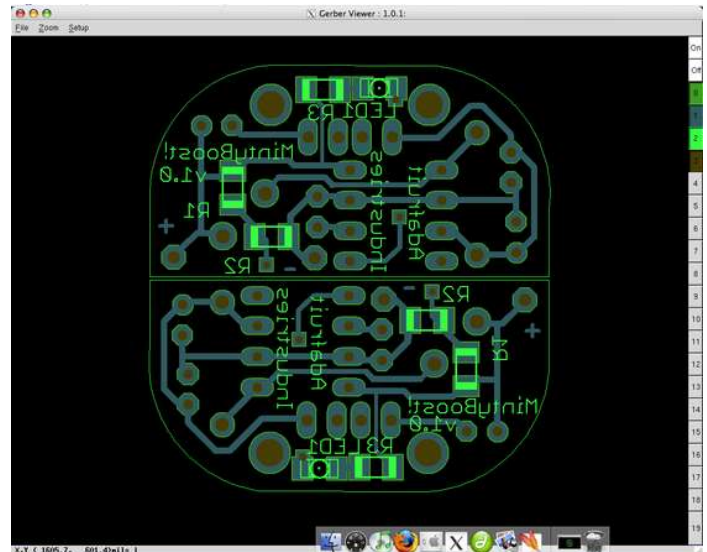
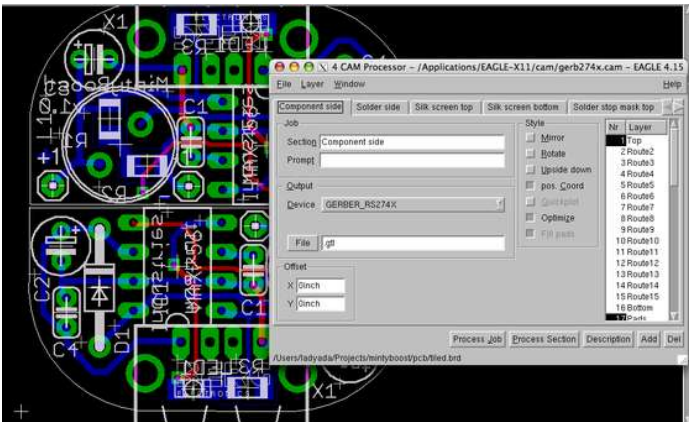

Image Notes

1. I added a low-battery indicator LED for people who want to add one in (its not stock)
2. Branding!
3. I've always learned: put the name of the project



step 11: Make: Tools

Ok, so you've got the kit. Here's how to build it!

First get your tools together. There are a few tools that are required for assembly. None of these tools are included. If you don't have them, now would be a good time to borrow or purchase them. They are very very handy whenever assembling/fixing/modifying electronic devices! I provide links to buy them, but of course, you should get them wherever is most convenient/inexpensive. Many of these parts are available in a place like Radio Shack or other (higher quality) DIY electronics stores.



Image Notes

1. Solder. Rosin core, 60/40. Good solder is a good thing. Bad solder leads to bridging and cold solder joints which can be tough to find. Don't buy a tiny amount, you'll run out when you least expect it. 1lb spools are a minimum.
2. Multimeter/Oscilloscope A meter is helpful to check voltages and continuity.
3. Soldering iron. Personally, I like the WES50 (now the WES51) and the other ~\$100 Wellers. One with temperature control and a stand is best. A conical or small 'screwdriver' tip is good, almost all irons come with one of these. A low quality (ahem, \$5 radioshack) iron may cause more problems than its worth. YMMV.
4. Good light. More important than you think.
5. Desoldering tool. If you are prone to incorrectly soldering parts. Some people prefer desoldering braid - a spool of finely braided copper wire.
6. 'Handy Hands' with Magnifying Glass. Not absolutely necessary but will make things go much much faster.
7. Flush/diagonal wire cutters. Essential for cutting leads close to the PCB.

step 12: Make: Parts

Next, you'll need your parts

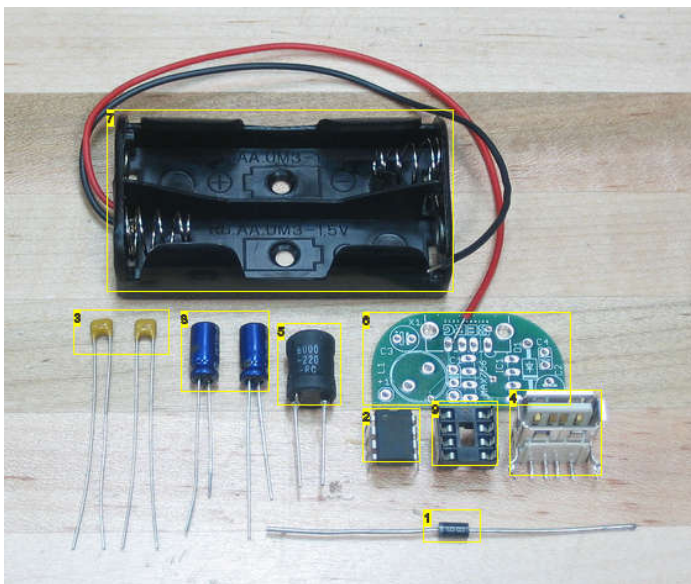

Image Notes

1. 1N5818 Schottky diode
2. IC1 MAX756 boost controller
3. C1, C4 Ceramic 0.1uF capacitors (Digikey BC1160CT-ND)
4. X1 USB type A jack (Digikey 609-1045-ND)

<http://www.instructables.com/id/MintyBoost!---Small-battery-powered-USB-charger/>

5. L1 22uH power inductor (Digikey 6000-220K-RC)
6. Double sided PCB (www.adafruit.com)
7. 2 x AA battery holder (Digikey 2463K-ND)
8. C2, C3 2 100uF/10V electrolytic capacitors (Digikey ECA-0JM101)
9. IC1* 8-DIP socket (Digikey 110-99-308-41-001000)

step 13: Make: Place diode and electrolytics

Place the two electrolytic capacitors C2 and C3 and the diode D1 in. Make sure you line up the white stripe on the diode with the white stripe in the picture on the circuit board. There are also white stripes on the capacitors, make sure they line up like in the picture to the left.

When you put the parts in, bend the wire leads out a little so the parts stay up against the board when you turn it upside down to solder.

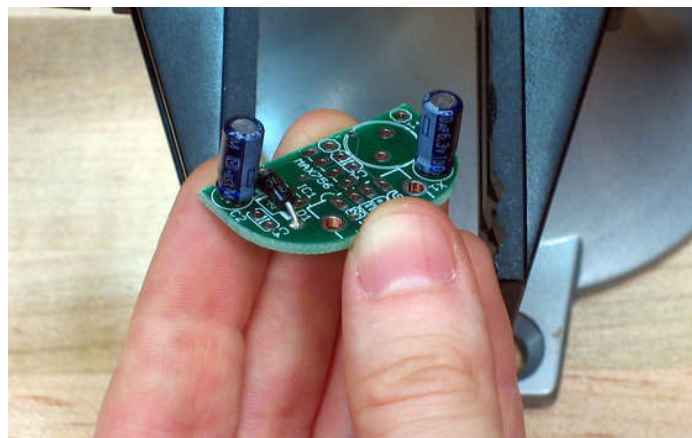

Image Notes

1. White stripe on this side
2. Diode stripe on this end
3. White stripe on this side

step 14: Make: Solder

The first step is to solder the kit together. If you've never soldered before, this tutorial is really awesome. If you're part of the new streaming-video-generation, this set of soldering mpegs may do you right.

Make sure the iron is 650deg. Touch the tip at a 45deg angle so that its heating both the hole/ring and the wire lead, then touch/poke the solder in with your other hand.

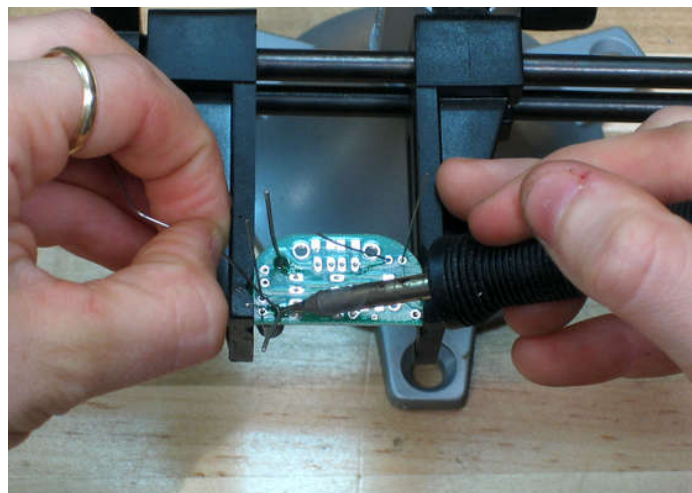
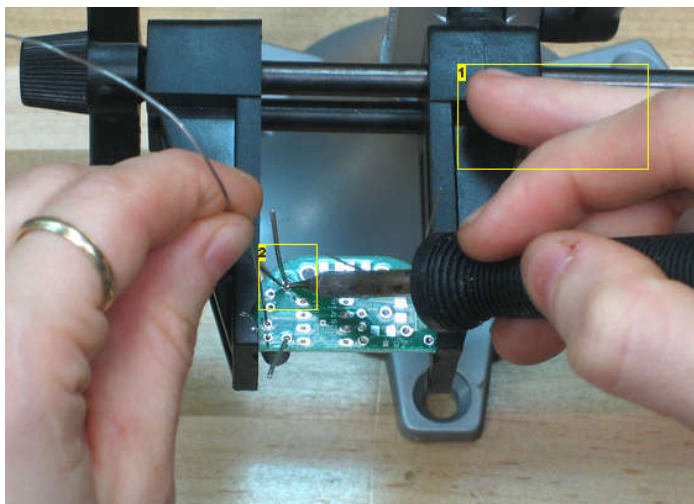
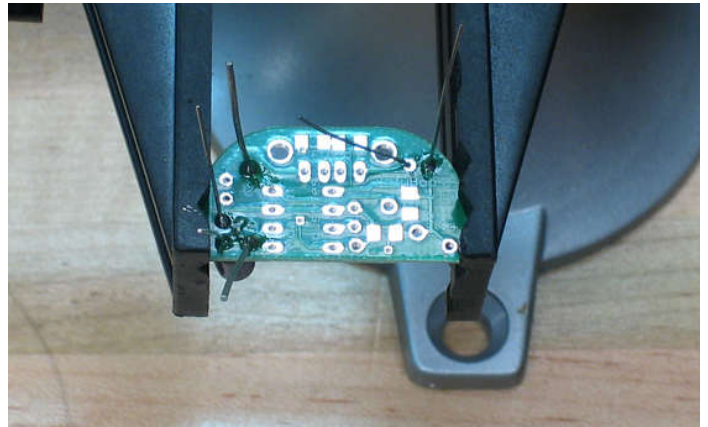
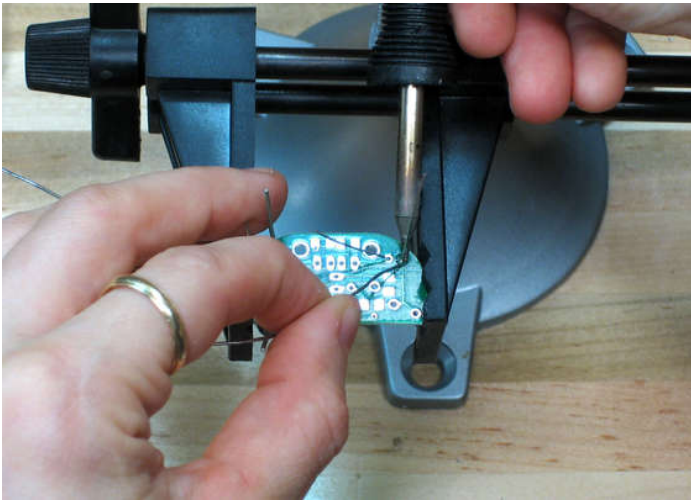

Image Notes

1. Steady your hand, by resting it on something or pressing a finger...
2. Hold tip of iron so it's touching both the ring and the lead, then poke solder in



step 15: Make: Clip

Clip the leads with the diagonal cutters. Be careful that the leads don't fly at your face. Cut the wires right above where the solder joint tapers off.

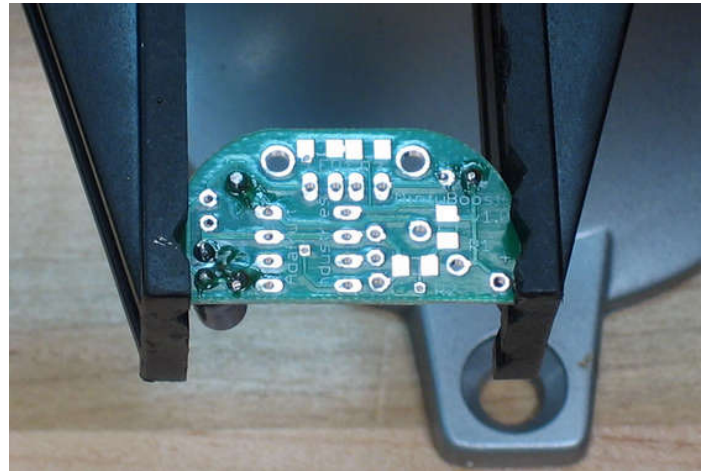
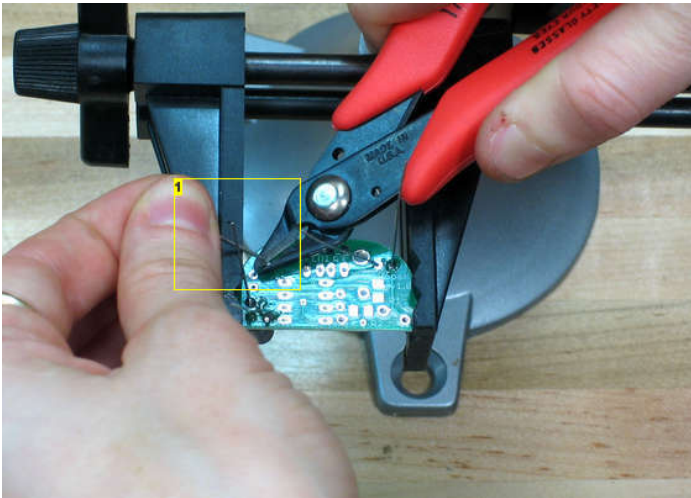

Image Notes

1. Hold onto the lead so it doesn't fly into your eyes!

step 16: Make: Place ceramic capacitors, inductor & jack

Place the two yellow ceramic capacitors C3 and C4, the power inductor L1 and the USB jack. The capacitors and inductor don't have a polarity, like the other capacitors and diode, so don't worry about putting them in backwards.

Solder these parts in too. When soldering in the USB jack, make sure to put plenty of solder in the two large side holes: they are the mechanical connection for the jack. If you don't make a good solder joint (filling in the hole completely with solder) then the jack will eventually break! So do a good job.

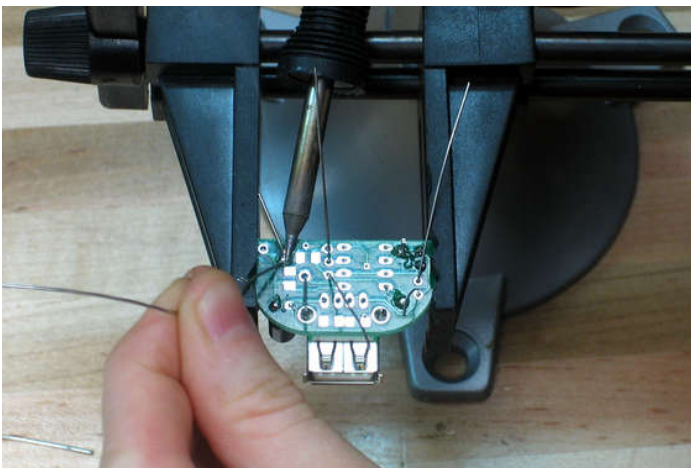

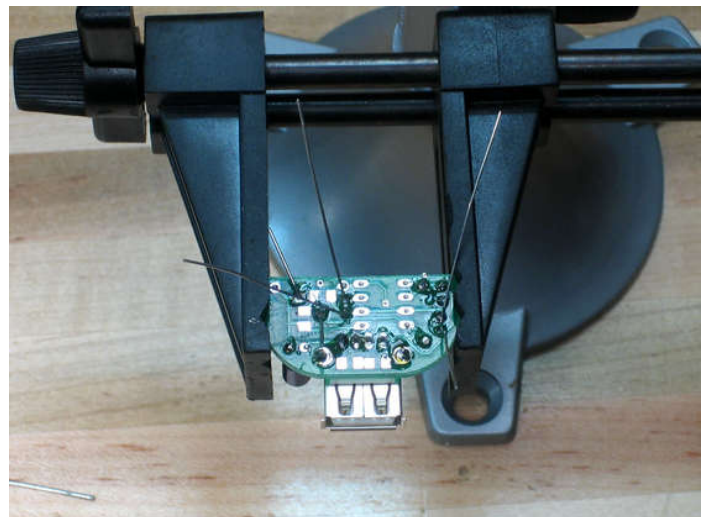
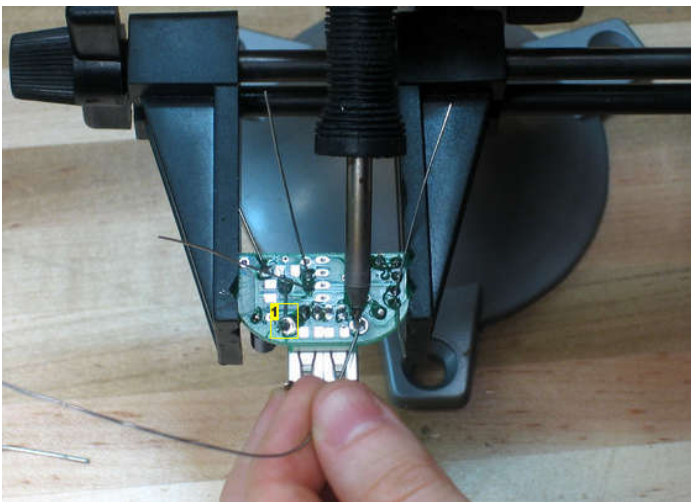
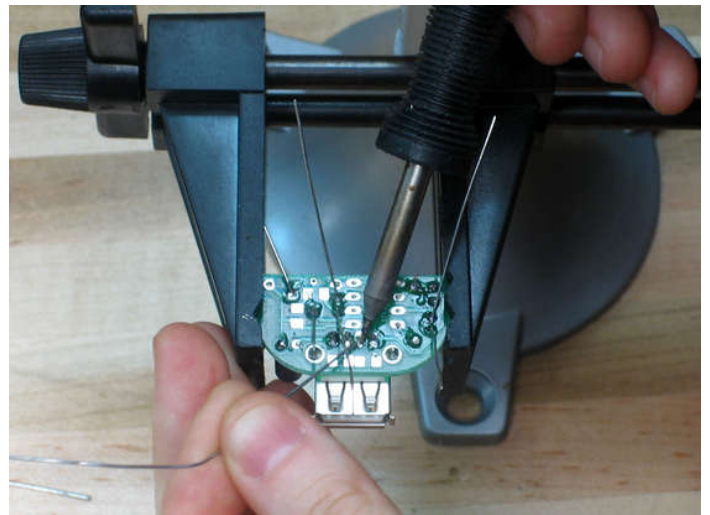
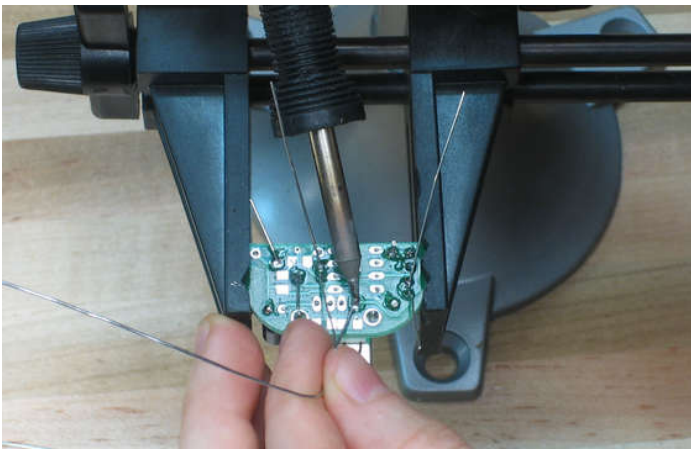
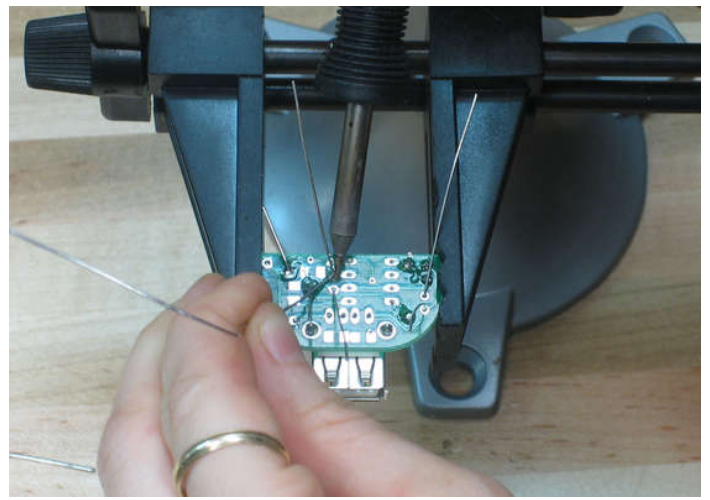
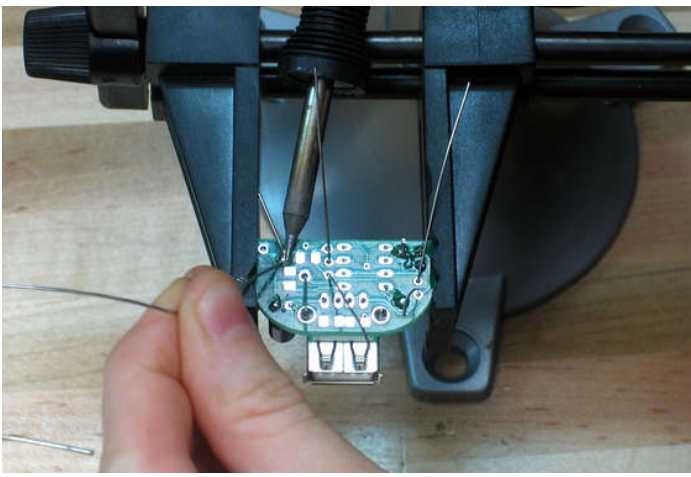
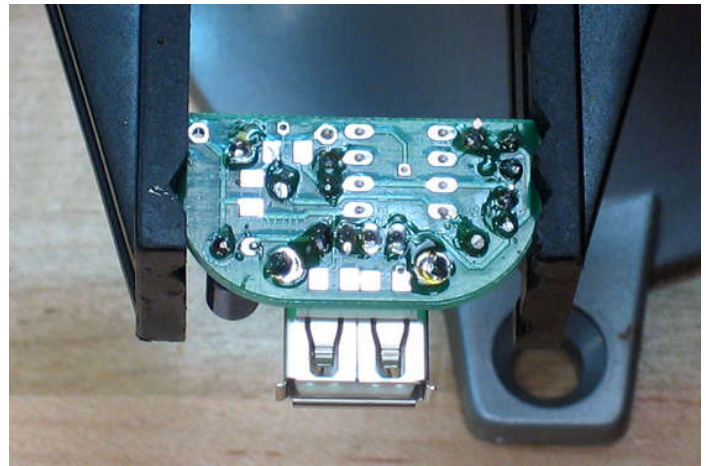
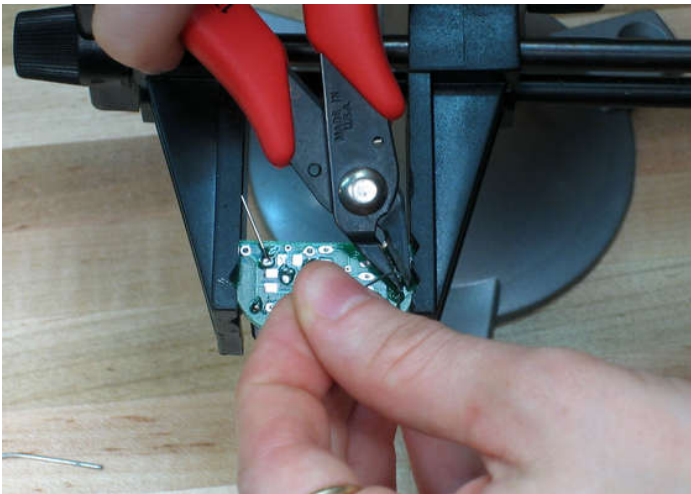

Image Notes

1. Make sure to fill the hole with solder to make a nice mechanical connection

step 17: Make: Clip 2

Clip the excess wires here too. Don't clip the USB jack leads: they're just the right size.



step 18: Make: Final soldering

Place the 8 pin socket so that the notch is next to the jack, just like the silkscreened image on the PCB. Also put in the wires for the battery pack, make sure you don't mix them up! The red wire goes in the corner.

Solder the pins of the socket, and the two wires. You might have to hold them against the board from underneath, if they seem to be slipping out.

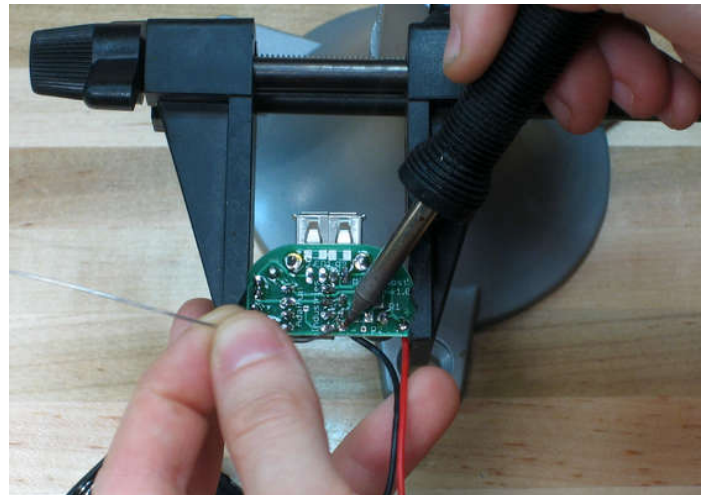
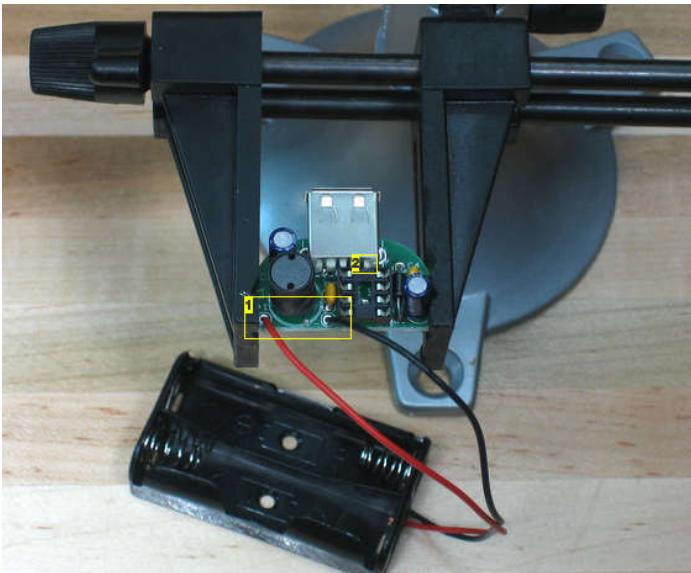

Image Notes

1. Note which wire goes where, dont get it backwards!
2. Notch of socket up here

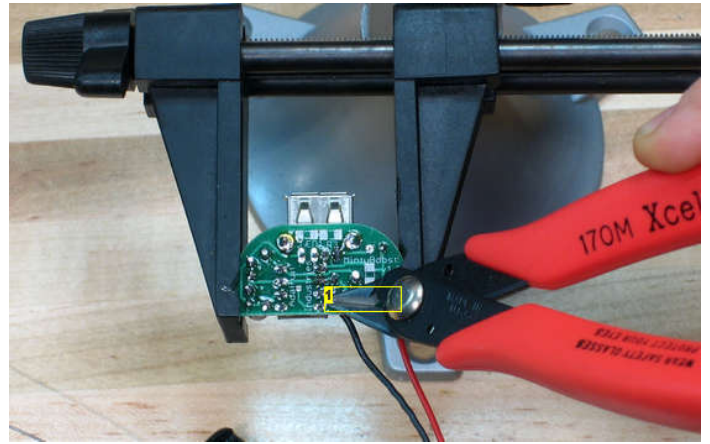
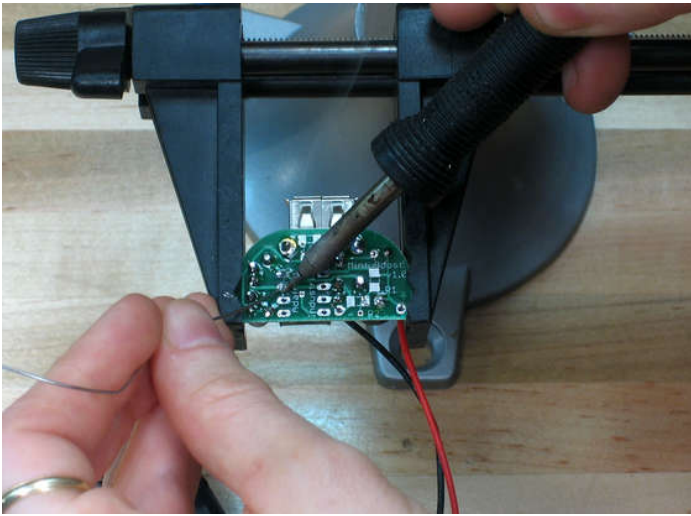

Image Notes
1. Clip just a little bit off

step 19: Make: Done!

OK, insert the MAX756 boost chip so that the little notch in the chip matches the notch in the socket. Make sure its well seated: press firmly, making sure all the pins are sliding into the socket straight. You're done!



Image Notes
1. Insert the chip so the notch is over here, like the socket

step 20: Test: Make sure it works

Now that it's built, its smart to do some minor tests to verify it's working properly. You'll need a multimeter with continuity test and voltage measuring capabilities, which every multimeter has. Read the manual to verify how to get into the modes you want.

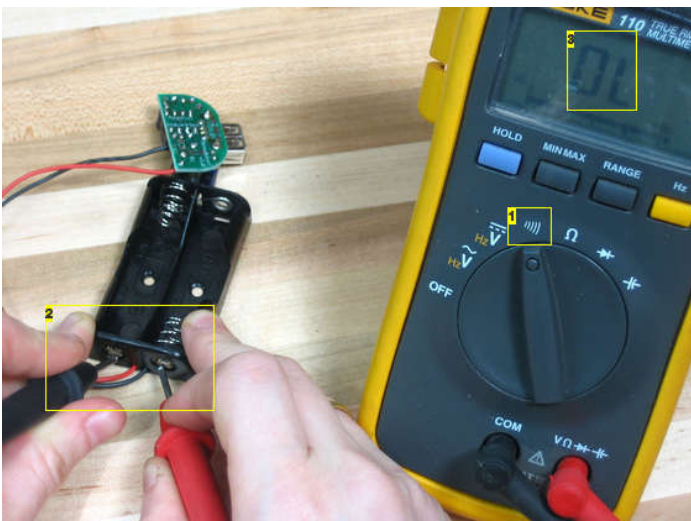

Image Notes

1. Continuity test mode
2. Do an input continuity test to make sure there isn't a short-circuit into the board.
3. On this multimeter, 0L means there isn't a short

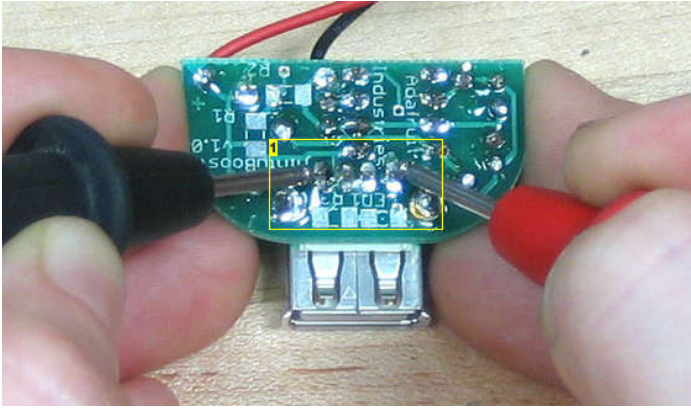

Image Notes

1. Make sure you're really pressing into the joints, there's a slight coating of rosin which you have to punch through



Image Notes

1. Insert two batteries, and put the meter in DC voltage measure mode. Do an input voltage test, to make sure you've got good batteries, 2-3V total is good.

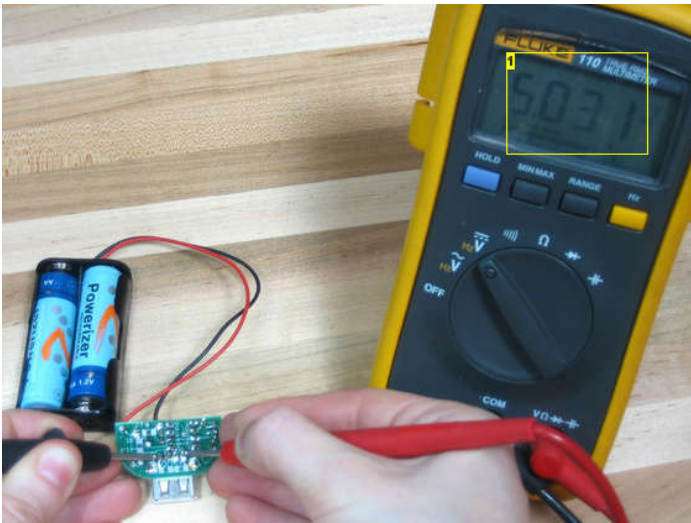

Image Notes

1. 5V! yay!

step 21: Case: Mintification

OK, now you're ready to put it in the case. Go buy a tin of Altoid gum, and eat them or give them to your friends. I think they're disgusting so don't send them to me.

You'll need the MintyBoost kit, an empty gum tin, a pair of tinsnips and two pieces of doublesided foam sticky tape (the tape is included in the kit).

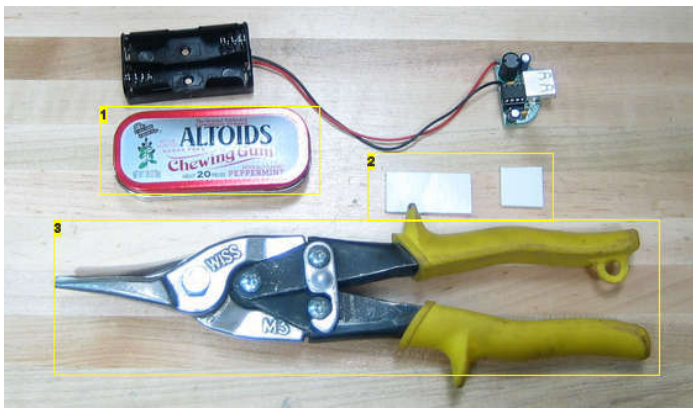

Image Notes

1. Recycle!
2. Double sided foam tape (comes with kit)
3. Tin snips...don't use your diagonal cutters, make sure you have a tool meant for cutting metal

step 22: Case: Cut

Cut two notches in the end of the tin, just about where the flat part ends and the tin starts to round out.



step 23: Case: Bend

Now you want to bend the flap back and forth to break it off, if you're careful you can bend it in more than out which will make it round into the tin, one less sharp edge.



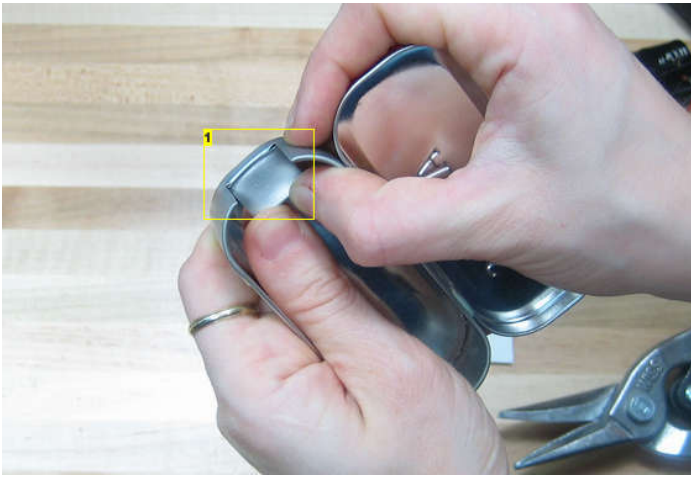

Image Notes

1. Note slightly curled in edge



step 24: Case: Test fit

Try a test fit. Slide the board in first, then fit the battery pack in.

Don't put the batteries in for this test! The circuit board could short against the tin and destroy the circuit!



Image Notes

1. Make sure it closes well
2. Make sure this part fits well, the notch is deep enough so the jack doesn't interfere with the hinged top.

step 25: Case: Final fit

Once you're happy, remove the electronics and put the double-sided sticky foam tape on both the circuit board and the battery holder.

The tape keeps the circuit board in place as well as keeps the pins from shorting against the tin

You might have to push down on the battery holder once it's in, to "pop-out" the bottom a little...the case will not quite close otherwise.



Image Notes
1. Sticky tape!



Image Notes
1. Fit this part in first, making sure its all the way to the left (its a tight fit)



Image Notes
1. Tuck wires into here
2. Push remaining wire into here



Image Notes
1. Insert batteries!

step 26: Done!

That's it...go forth and boost!



Related Instructables



Energizer USB battery charger
by pcmofo



How to Charge Any USB Device by Riding Your Bike
by JeffB



Altoids Tin Speaker
by matth3w



iPod charging tins and packs for beginners...
by erckgillis



Switch Mode Altoids iPod Charger using 3 'AA' batteries
by ian



Advanced USB Device Charger
by VV.Core.



Super Simple Ipod Battery Charger (Altoids Tin)
by tyeo098



PLAY AND RECHARGE IPOD USING OLD BOOMBOX - Hints and tips
by unknownuser2007



Make a Custom Shirt at the Instructables Store

Comments

50 comments

[Add Comment](#)

[view all 348 comments](#)



sniperb says:
does this work with the ipod touch? Plz help!

Nov 4, 2008. 6:43 PM [REPLY](#)



K-n-e-x person says:
it works with anything that charges throughout a usb cable, so yes

Nov 10, 2008. 1:55 PM [REPLY](#)



Bartboy says:
Can you make some then sell on E-bay? because I dont really like doing this sort of work :P

Nov 8, 2008. 9:53 AM [REPLY](#)



K-n-e-x person says:
ya i dun like numbers and symbols =(

Nov 10, 2008. 1:54 PM [REPLY](#)



Geosync says:
ladyada, what is the vice tool in your pictures that holds your pcb while soldering? Sure would like one of those!

Oct 4, 2008. 7:34 PM [REPLY](#)



Geosync says:
For anyone else wondering the same thing, the vice is from Panavise.

Nov 6, 2008. 12:49 PM [REPLY](#)



davidglinski says:
is there any way that you would be able to switch the 2 double a's for a 9 volt battery or make more capcitors or something i dont know i am new at this so thanx

Nov 4, 2008. 6:06 PM [REPLY](#)



gosub says:
Very nice work. Maybe I would make the USB plug fit within the box... Well done anyway . For DEVA : IMO any 16/25 Volts will do.

Oct 28, 2008. 8:31 AM [REPLY](#)

 **Electrolight** says: Oct 23, 2008. 7:06 PM [REPLY](#)
This seems soooo coooooo!
Anyway I was wondering if someone can put this in plain, do this get this connect here english... minus the math, theory and big words?

If not i guess i can spend a weekend figuring out how to build this thing... can't be that hard can it?

famous last words lol
thx anyway

 **shedwasp** says: Oct 15, 2008. 4:38 PM [REPLY](#)
Hi,

This is a really great idea....I just finished reading it a few seconds ago. This isn't really related to your Instructable, but do you know where someone may start to learn about electrical engineering? Just basic stuff, nothing for a career...more like a hobby. I know pretty much nothing about it.

 **Derinsleep** says: Oct 17, 2008. 10:58 PM [REPLY](#)
buy a good book/s about electronics and ead them,thats what i did

 **1578bb** says: Sep 29, 2008. 7:20 AM [REPLY](#)
its a pretty nice project. only one thing..how do you make the pboard.?

 **cantthinkof bettername** says: Sep 25, 2008. 3:07 PM [REPLY](#)
Could I use a ps2 to make this?

 **pedrotome** says: Aug 21, 2008. 9:33 AM [REPLY](#)
Could you draw the schematic by hand? I really don't understand that Eagle schematic in step 7!!! Is pin 4 connected to anything? Where do I connect the batteries' + and -????
If you could draw it by hand, I'd appreciate it. A lot.

Thanks.

 **_Ko0LaiD_** says: Sep 3, 2008. 9:01 PM [REPLY](#)
they did that so you will buy it.

 **pedrotome** says: Sep 4, 2008. 7:27 AM [REPLY](#)
But I don't want to buy it, I want to MAKE it. :o
This is a site for MAKERS not BUYERS. :oooo

 **_Ko0LaiD_** says: Sep 4, 2008. 4:54 PM [REPLY](#)
i dont want to buy it either, thats why i made it :-D

 **jake21** says: Aug 7, 2008. 1:13 PM [REPLY](#)
can u make me one and ill buy it

 **nc527** says: Aug 6, 2008. 11:02 AM [REPLY](#)
I ordered the parts for this from digikey yesterday total was like 10 something -shipping and to any1 whos ordered from digikey why doesnt it tell me shipping cost when i order it?

 **Angus06** says: Jul 16, 2008. 11:36 PM [REPLY](#)
When designing something like this, how do you know how many capacitors and of what capacitance to use in a charger?

 **alex-sharetskiy** says: Jul 22, 2008. 8:39 AM [REPLY](#)
There's a formula somewere out there...
get a large capacitor, 1000uF, it should be enough

this circuit CAN be built without any capacitors, but your iPod might not like it



Angus06 says:

Jul 24, 2008. 12:21 PM [REPLY](#)

Yeah I'm interested simply because im learning about basic electronics and all that good stuff and I like knowing mathematically what I'm doing rather than just copying something someone else's design, regardless of how good it is. Any idea of where I could look for that formula or why capacitors are used in chargers? (thanks for the 1000uF recommendation, by the way)



alex-sharetskiy says:

Jul 24, 2008. 1:01 PM [REPLY](#)

um, capacitors are like uber batteries, they can be charged with a lot of current, they weigh less, and have higher voltages (though they do no store massive amounts of electricity)

capacitors even out little voltage spikes and dips
AC charges put out dips and spikes, so capacitors even them out for less humm (if in speakers)



Angus06 says:

Jul 25, 2008. 10:21 PM [REPLY](#)

Ah! Wait, so why put them in a charger whose power source is batteries (DC)? Or do batteries also have spikes etc.? The main problem for me is that I have no sense of how to figure out what voltage/capacitance I should be looking for (for capacitors, of course) in designing something like this.



alex-sharetskiy says:

Jul 25, 2008. 11:00 PM [REPLY](#)

your output voltage will be 5V look for higher than 5V(capacitor)best bet is 6.3V, there are like 5 on a PC motherboard

capacitors discharge current faster, so the battery charges the capacitor and the capacitor powers the device, kind of, say your device consumes 100mah, it will run off the battery, but if your device needs 300mah for a split second, you battery can't put out that much, so the capacitor gets drained,

i don't know if this helped, so um tell me!



Angus06 says:

Aug 5, 2008. 10:18 AM [REPLY](#)

Haha that makes sense. I'm figuring on getting a DC electronics book or something, and that will hopefully help me with the math stuff that I can't find anywhere (how many capacitors/what capacitance, among other problems).
Thanks!



alex-sharetskiy says:

Aug 5, 2008. 2:54 PM [REPLY](#)

no problem, any other questing, ask me, or post a forum topic!



nc527 says:

Aug 5, 2008. 6:36 AM [REPLY](#)

can i get all the parts for this at radioshack?if not suggest a store near greenville nc



CalcProgrammer1 says:

Jul 29, 2008. 12:11 PM [REPLY](#)

This looks like a pretty neat design. The step-up power supply is neat. However, my device (Dell Axim X50v) also charges from 5v but in order to work well needs at least one amp of current (its power pack is rated at 2.6A). I had to use a regulator based circuit (using two 7805's to max out at 2A) and an 8AA battery pack. It is horribly inefficient though, when under heavy loads the 7805's generate tons of heat making the circuit (housed inside a 9v battery case) too hot to touch. What is the maximum current output of a step-up circuit like this? I'm assuming 500mA, considering that's standard for USB.



rjesco says:

Jul 29, 2008. 6:36 AM [REPLY](#)

does anyone know of a reason this wouldn't work on iphone/touch???? please help



Wolfpack871 says:

Dec 30, 2007. 5:26 PM [REPLY](#)

I made one of these for my 5.5 Generation iPod Video and it works fantastic, it'll charge it about 1.5 on 2 AA batteries, works great with rechargables.

I find the best use for this thing is charging your iPod in the car on a long trip, where watching LOTR will burn your battery, and for just under 20 bucks?



gizmology says:

Jul 24, 2008. 11:40 AM [REPLY](#)

Actually, a better method for car-charging is the cigarette lighter plug-in gadget that allows your iPod to output as a station on a radio frequency you can then pick up with your car radio. That way, you're using the car battery to charge the iPod while you listen and you never have to resort to those \$6.00/4-pack rest-stop AA Energizer rip-offs! I've actually been using mine only as a charger, since the car I've been driving has a jack that makes the car speakers act as headphones.





chinnerz says:

Jul 23, 2008. 11:58 PM [REPLY](#)

I need some help :(, I can't seem to find any of the chips you said we could use. can I use the "MC34063", it looks right but I am a total noob when it comes to this sort of stuff.

 **Plasmana** says: Also 1+ vote! Jul 16, 2008. 3:41 AM [REPLY](#)

 **Plasmana** says: Wow! That is a great instructable! I will build a minty-boost charger as soon as I get USB charged devices. Jul 16, 2008. 3:38 AM [REPLY](#)
5 star rating!

 **napzter** says: This is great. I followed your instructable but modified it so instead of a USB cable it's a Mac recharging cable. It works great. Jul 15, 2008. 9:47 AM [REPLY](#)

 **circuitpeople** says: Since not everyone has EAGLE (yeah, they could have it but not everyone does have it or know how to use it), and since not all board houses accept EAGLE files (ditto) I exported gerbers from for the PCBs and uploaded them to www.CircuitPeople.com: Jul 14, 2008. 12:10 PM [REPLY](#)
<http://www.circuitpeople.com/ViewPackage.aspx?id=b3bc33b8-4077-4c77-b8d8-c750d5eac2f2>

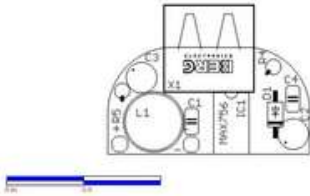

 **omkar_hummer** says: wats the vottage output ? Jun 14, 2008. 5:22 AM [REPLY](#)

 **bikeradam** says: If you read it clearly, it gives out the standard USB voltage; 5v. I don't know about the current the chip could deliver, but I'm sure the max is about .5A from a computer, maybe less from the chip. Jul 14, 2008. 3:51 AM [REPLY](#)
Adam.

 **adicontakt** says: it-s work with ipod nano 3rd gen? Jul 6, 2008. 9:53 AM [REPLY](#)

 **culturalsalad** says: is it possible to add a handful of batteries to this setup... lets say around 14 or maybe 28? Jun 22, 2008. 9:48 PM [REPLY](#)

 **alex-sharetskiy** says: Can you use any type of diode? Jun 21, 2008. 6:15 PM [REPLY](#)

 **omkar_hummer** says: could i use a voltage transformer instead of pcb?? Jun 14, 2008. 5:22 AM [REPLY](#)

 **SLKestrel** says: this is so cool! If I use it on an iPod, though, there's no way it could harm it or its battery, right? Jun 12, 2008. 4:29 PM [REPLY](#)

 **skaterdude243** says: dude did you see your instructable on dl tv look it up usb charger dl tv any way nice job keep it up May 28, 2008. 3:59 AM [REPLY](#)



jippie says:

Pretty cool, I was just wondering one step more.

I would like to use re-chargeables, but I would like to add the circuit to be able to charge the batteries. This way when I find a USB port I can plug it in and get it charged up again for the next use?

Apr 21, 2008. 7:40 AM [REPLY](#)



collard41 says:

you could use a spdt switch and a bit extra on the circuit board so you can switch between charge and charge (i mean passive and active charging)

May 26, 2008. 3:17 PM [REPLY](#)



jippie says:

It is the circuit that is the problem :)

May 27, 2008. 12:16 AM [REPLY](#)



nintandrew says:

If I used 3 AA batteries for a total of 4.5 volts, would it still work?

May 1, 2008. 9:52 PM [REPLY](#)



jjmaia says:

I have that question too, because i cant get the MAX756.

Thank you.

May 16, 2008. 7:44 AM [REPLY](#)

[view all 348 comments](#)