

An Overview of the Underestimated Magnetic Loop HF Antenna

It seems one of the best kept secrets in the amateur radio community is how well a small diminutive magnetic loop antenna can really perform in practice compared with large traditional HF antennas. The objective of this article is to disseminate some practical information about successful homebrew loop construction and to enumerate the loop's key distinguishing characteristics and unique features. A magnetic loop antenna (MLA) can very conveniently be accommodated on a table top, hidden in an attic / roof loft, an outdoor porch, patio balcony of a high-rise apartment, rooftop, or any other tight space constrained location.

A small but efficacious HF antenna for restricted space sites is the highly sort after Holy Grail of many an amateur radio enthusiast. This quest and interest is particularly strong from amateurs having to face the prospect of giving up their much loved hobby as they move from suburban residential lots into smaller restricted space retirement villages and other shared residential communities that have strict rules against erecting antenna structures. In spite of these imposed restrictions amateurs do have a practical and viable alternative means to actively continue the hobby using a covert in-door or portable outdoor and sympathetically placed low visual profile small magnetic loop. This paper discusses how such diminutive antennas can provide an entirely workable compromise that enable keen amateurs to keep operating their HF station without any need for their previous tall towers and favourite beam antennas or unwieldy G5RV or long wire. The practical difference in station signal strength at worst will be only an S-point or so if good MLA design and construction is adopted.

Anyone making a cursory investigation into the subject of electrically-small antennas exemplified by the magnetic loop antenna using the Google internet search engine will readily find an overwhelming and perplexing abundance of material. This article will assist readers in making sense of the wide diversity of often times conflicting information with a view to facilitate the assimilation of the important essence of practical knowledge required to make an electrically-small loop work to its full potential and yield very good on-air performance with a capable account of itself vis-à-vis time proven favourite HF antennas.

A few (sobering) facts

A properly designed, constructed, and sited small MLA of nominal 1m diameter will equal and oftentimes outperform any antenna type except a tri-band beam on the 10m/15m/20m bands, and will at worst be within an S-point (6 dB) or so of an optimised mono-band 3 element beam that's mounted at an appropriate height in wavelengths above ground.

Magnetic loops really come into their own on the mid to higher HF bands from say 40m through to 10m; frequently exhibiting absolutely stunning performance rivalling the best conventional antennas. Easily field deployable and fixed site tuned loops have been the routine antenna of choice for many years in professional defence, military, diplomatic, and shipboard HF communication links where robust and reliable general coverage radio communication is deemed mandatory. On 80m and 160m top-band where the attainable (size constrained) efficiency is diminished the performance of a small loop antenna still generally exceeds that achievable from a horizontal half-wave dipole, particularly one deployed at sub-optimal height above ground. This is a very common site limitation for any HF antenna on the lower bands.

The real practical advantage of the small loop compared to say a short vertical whip tuned against earth or a full quarter-wave vertical antenna is the loop's relative freedom from dependence on a ground plane and earth for achieving efficient operation; this unique characteristic has particular profound significance for realising small restricted space antennas operating on the lower 80m and 160m HF bands.

Comparing the efficiency of a short or full-sized vertical with a small loop antenna one trades ground dependency and earth losses for much easier controllable conductor losses in both the loop radiating element and ohmic loss in the associated tuning capacitance and interconnections.

A short whip or dipole is capacitive, and so needs inductance to be added to bring the antenna to resonance. The converse is true for a small loop. It just happens to be true that high quality low loss capacitors are much easier to make than high quality low loss inductors. Therefore a small loop resonated by a capacitor will have much higher Q than a short dipole resonated by an inductor. Having started from a better position, we then have more freedom to balance off bandwidth versus efficiency in design of the MLA.

So where's the catch; if the small loop is such a good antenna why doesn't everyone have one and dispense with their tall towers and traditional large antennas? The laws of nature and electromagnetics cannot be violated and the only unavoidable price one pays for operating with an electrically-small antenna is narrow bandwidth. Narrow instantaneous bandwidth rather than poor efficiency is the fundamental limiting factor trade-off with small loops.

A small antenna exhibits a compromise between bandwidth and efficiency whereby a small antenna with high bandwidth always has low efficiency. The two parameters are inextricably linked, in that it is the same resistive losses that both broaden the bandwidth and reduce the efficiency. In some cases the loss resistance may be intrinsic to the antenna structure; in other cases it may arise from coupling to its surroundings (which then means a lossy antenna will not necessarily heat itself). A larger antenna can combine high bandwidth and high efficiency because it beneficially uses radiation resistance to achieve both.

Any small and compact (in terms of a wavelength) antenna will inherently be narrow band and require tuning to the chosen operating frequency within a given HF band. Users of magnetic loops must be content with bandwidths of say 10 or 20 kHz at 7 MHz or a little more than 0.2%. They are content as long as the small loop antenna can be easily tuned to cover the range of spot frequencies that they wish to operate on. For a remotely sited or rooftop mounted antenna implementing this tuning agility to QSY across the band requires just a modicum of that ingenuity and improvisation radio hams are renowned for, e.g. illustrated in Figures 15 and 16.

A small transmitting loop (STL) antenna is defined as having a circumference of more than one-eighth wavelength but somewhat less than one-third wavelength (this size setting the boundary constraints) which results in an approximately uniform current distribution throughout the loop and the structure behaves as a lumped inductance. Unlike a short vertical or dipole antenna, the loop presents an inductive reactance at its terminals so tuning and matching is conveniently accomplished with a single capacitor element. The loop self-inductance can be resonated with capacitance to form a high-Q parallel tuned circuit. The antenna Q is very high because the radiation resistance is small compared to the reactance of the loop and the VSWR bandwidth is very narrow. The attainment of a high-Q and the observation the antenna does not spontaneously burst into flames like a Roman candle and self-destruct under QRO high-power excitation tells us that the loop antenna per se is not lossy and inefficient. When power is applied to the loop at its resonant frequency *all* of that power will be radiated except that portion absorbed in the lumped I^2R conductor and capacitor losses manifesting as wasteful heat. With proper design and careful construction these deleterious series equivalent internal circuit losses can be made negligible or at least sufficiently small compared to the loop's radiation resistance such that a resultantly high *intrinsic* radiation efficiency and commendably good antenna performance can be achieved from a relatively small HF antenna structure. Splendid!

The radiation resistance R_r is a non-dissipative impedance associated with the antenna input power that is transferred to the surrounding propagation medium.

The vertically oriented STL antenna's figure-of-8 doughnut shaped radiation pattern maximum is in the plane of the loop with far-field nulls (for small loops) at right angles to the plane of the loop. This null progressively fills in as one makes the loop diameter larger. By the time the loop diameter is about $\lambda/8$ there should be appreciable radiation along the loop axis. Vertical oriented loops function perfectly well close to ground level. When horizontally mounted, the antenna pattern is omni-directional with nulls straight up and straight down. However, horizontally oriented loops couple strongly to ground and should be elevated a significant fraction of a wavelength above ground to prevent the incursion of significant ground losses; consequentially deployment of this loop orientation is uncommon.

Current flow through the loop's radiation resistance results in RF power being converted / transmuted into electromagnetic radiation. A propagating radio wave transporting power in the Poynting vector must comprise both magnetic and electric field components in a prescribed ratio in order for it to exist. In the case of an STL, a strong magnetic field is generated by passing a substantial RF current through the loop conductor and this magnetic field in turn generates a corresponding electric field in space thus providing the two essential and inextricably linked E and H component elements. This is where the term "magnetic loop" antenna originates. The radiation resistance of a small loop antenna is proportional to the square of the peak magnetic dipole moment of the antenna. This dipole moment is roughly the product of the peak current times the area of the magnetic loop antenna. Reciprocity applies in the antenna receiving sense.

Loop antennas have enclosed area, and generate magnetic flux fields that thread this area. These changing magnetic fields generate a back EMF at the loop terminals in quadrature phase with the original excitation which provides the loop with inductive reactance. The larger the area, the larger the self-inductance. However, as the loop conductor perimeter becomes longer, the phase shift between induced voltage and the current that gives rise to it changes. At a certain length, generally held for circular loops to be about $1/3$ wavelength, the loop becomes "self resonant". A self-resonant antenna might be thought of as being "optimally efficient". Smaller loops require additional series or shunt capacitance to tune them to resonance so that the impedance presented to the feed becomes real, i.e. $R \pm j0$. In a self-resonant loop, it is clear that the standard small-loop theory breaks down. This happens for total conductor length of between $1/3$ and $1/2$ of a wavelength. The current distribution around the loop will then be very non-uniform; the radiation resistance will be quite large, and will likely swamp the loss resistance.

However, since the small loop's radiation resistance is very small compared to that of a full sized resonant $1/2 \lambda$ dipole, getting a favourable ratio of loss to radiation resistance is the only "tricky" and challenging part of practical loop design and homebrew construction. The current flowing through an antenna's radiation resistance when squared and multiplied by that resistance determines the amount of power that's actually radiated. Due to the relatively low value (few hundred milli-Ohms) of a small loop's radiation resistance, high currents (many tens of Amperes) are necessary to enable even moderate powers to be radiated; so it is essential that all contributing sources of loss must be kept low in comparison with the radiation resistance in order to achieve high efficiency with the majority of the antenna input power transmuted into the radiation field, rather than being unproductively dissipated as Joule heat energy in all of the sources of deleterious loss resistance (both internal and external coupled loss).

Some qualitative theory

The transmitting efficacy / efficiency of electrically-small loop antennas of all kinds and design permutations is critically dependent on achieving very high unloaded Q values in both the loop conductor element and associated tuning capacitor. The attainable radiated field is a direct function of the Q times boost in resonant RF circulating current in the small loop conductor; that large current magnification is essential to compensate for the Lilliputian radiator size.

For a small (in terms of a wavelength) uniform current carrying loop, every elemental part of the loop conductor cancels radiation from every other part; except for a relatively tiny bit that remains due to the phase shift caused by the time required for the charge to physically move from one part of the loop conductor to another. The small phase shift produced by the transit across the loop is crucial; without which there would be no radiation at all from the small MLA.

As the loop conductor circumference gets increasingly smaller and smaller in relation to the wavelength, the Q rises rapidly and consequently more and more energy is contained within the close-in reactive energy storage near-fields. The RF energy exchange then merely oscillates back and forth between the L and C (both lumped and distributed C) reactive components; and in the extreme limit case of small loop dimensions asymptotes towards and behaves like a familiar lumped-element resonant tank circuit, i.e. the L-C structure is essentially non-radiating.

We know from basic theory that electromagnetic radiation is caused by charge acceleration; and we know current is caused by charge movement. The amount of antenna EM radiation is directly determined by the linear spatial distance charges are accelerated over. At the end of the day antenna radiation ultimately comes down to just one thing; current over linear spatial distance. The ultimate requirement is that we always need a certain number ampere-metres to transmute and radiate a given power into an electromagnetic field. Consequently whenever we make an antenna's dimension shorter like in a small magnetic loop, antenna current has to proportionately increase to radiate the same power. If we fold a lineal antenna element back on itself, or spiral a full-size antenna up into a tight wound helix, current has to increase in order to radiate the same power. If we compress the current into a smaller linear physical area, current has to increase to radiate the same power as that of uniform current over the same area. This is because we have fewer spatial metres, so accordingly we need more Amperes of RF current to radiate the same power level.

The underlying EM physics at play here is inviolable; dissipative losses from all contributing sources must be avoided when endeavouring to build an efficacious magnetic loop antenna.

Some practical construction guidelines

Through utilizing a large sized split-stator (see Figure 1) or a similar butterfly style air variable capacitor construction, or preferably a vacuum variable capacitor, low loss can be achieved in the tuning capacitor. Conductor loss can then be controlled by optimal choice of the diameter of copper tubing used to form the loop element and paying very careful attention to achieving low ohmic interconnections to the capacitor such as welded or silver soldered joints, wide copper straps, etc. With 100 Watts of Tx drive power there are many tens of Amperes of RF circulating current and large Volt-Amps-Reactive (VAR) energy flowing in the loop conductor and tuning capacitor; particularly with small loops operating on the lower HF bands.

In the case of an air variable, capacitor I^2R distributed losses are further minimised by welding the rotor and stator plates to the stacked spacers to eliminate any residual cumulative contact resistance. When connected across the loop terminals the butterfly construction technique inherently eliminates any lossy rotating wiper contacts in the RF current path. The configuration permits one to use the rotor plates to perform the variable coupling between the two split stator sections and thus circumvent the need for any lossy rotor wiper contacts to carry the substantial RF current. Since the fixed stator plate sections are effectively in series, one also doubles the RF breakdown voltage rating of the composite capacitor. In view of the fact the loop antenna is a high-Q resonant circuit, many kilovolts of RF voltage can be present across the tuning capacitor and appropriate safety precautions must be taken during Tx operation. Small transmitting loop antennas capable of handling a full 400 Watts PEP or greater are readily achievable when appropriate construction and capacitor plate spacing tuning components are carefully selected.

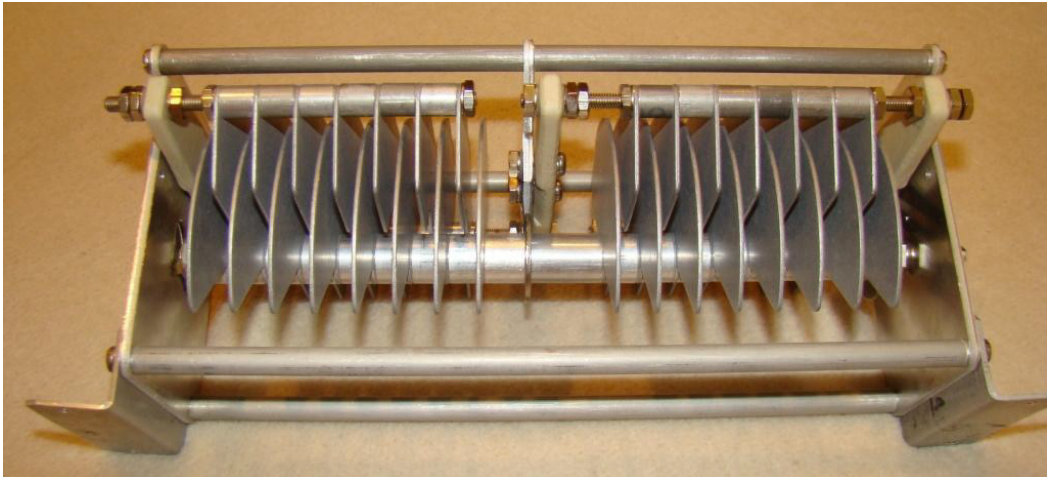

Figure 1 Large wide spaced split-stator style air variable capacitor

With large air variables the older mil-style or broadcast transmitter silver plated brass stator and rotor plate constructions have lower losses than does aluminium construction. These variable “bread slicer” caps can also be homebrewed. The large split-stator variable capacitor illustrated in Figure 1 was produced by the Cardwell / E.F. Johnson Company and readily available in radio parts surplus markets and hamfest swap meets.



Figure 2 Vacuum variable style low-loss capacitors

Figures 2 and 3 pictorially illustrate examples of low ESR, low loss, high-Q vacuum variable capacitors for yielding very low conductor and dielectric losses in the loop tuning element while providing smooth vernier control of capacitance with typically 36 or more shaft rotation turns to traverse through the capacitance range. Note the large surface area silver-plated contact flanges.



Figure 3 Large kVA / VAR rated vacuum variable capacitor

Feeding and matching

Although loop antennas have deceptively simple appearance and equivalent circuit, they are complex structures with radiation patterns and polarisation characteristics dependent on whether they're fed in a balanced or unbalanced fashion. The purpose of matching is to increase the current through the antenna's radiation resistance to the maximum available magnitude resulting in a radiated power of $I^2(R_r)$ from the antenna. The method of feeding and matching the loop resonator, ground plane configuration, as well as the geometric form factor and physical proportions of the loop element itself are all fertile ground for experimentation. Various matching methods include series capacitor, transformer coupled subsidiary shielded-Faraday loop, simple unshielded coupling loop, auto-transformer gamma-match, and toroidal current transformer (CT); each with their respective merits. These techniques with exception of the asymmetric unbalanced series capacitor narrowband matching method will be discussed in turn.

The choice really boils down to personal preference as both the gamma and Faraday feed techniques work well. However, the Faraday shielded auxiliary loop or a CT located at the bottom central symmetry plane (located directly opposite the tuning capacitor) yields better loop electrical symmetry and balance that can in turn provide sometimes beneficial deeper front-to-side ratio and pattern nulls. In addition to imparting slight pattern asymmetry the Gamma match method can also result in some deleterious common-mode current flow on the outer braid of the feed coax that might need choking-off and isolating with a ferrite decoupling balun to prevent spurious feeder radiation and extraneous noise pick-up on Rx. Much also depends on the site installation set up in respect of proximate conductive objects in the loop's near field that can disturb the antenna's symmetry and balance.

With the elegantly simple transformer-coupled Faraday loop feed method the 50Ω signal source merely feeds the auxiliary loop; there's no other coupling / matching components required as there are no reflected reactive components to deal with (the main loop appears purely resistive at resonance with just the core R_{rad} and R_{loss} components in series). The main loop conductor serves as one winding of a large RF air core transformer while a small one-turn auxiliary feed loop, fed by a coaxial cable, serves as the other winding. Refer to equivalent circuit Figure 5B.

The impedance seen looking into this auxiliary feed loop is determined solely by its diameter with respect to that of the primary tuned resonator loop. A loop diameter ratio of 5:1 typically yields a perfect match over a wide 8:1 or greater frequency range of main loop tuning. Simple transformer action occurs between the primary loop and the feed loop coupled circuit due to the highly reactive field around and near the resonant primary loop which serves to greatly concentrate magnetic flux lines which cut the small untuned feed loop. The degree of magnetic flux concentration is a function of the Q of the tuned primary which varies with frequency, i.e. the highest Q occurring at the lowest frequency of operation and the lowest Q exhibited at the highest frequency.

This variation in Q factor results from the variation in the sum of the loss resistance and the complex mode radiation resistances of the primary radiator loop as a function of frequency. The effective feed impedance of the secondary loop is controlled by its diameter / ratio of area and by the number of flux lines cutting it; thus the impedance seen looking into the secondary loop will be essentially independent of frequency. One can intuitively see this because when the feed loop is extremely small in relation to a wavelength at the lowest frequency of operation, the number of magnetic flux lines cutting it is large because of the very high Q, whereas when the feed loop becomes a larger fraction of an operating wavelength as the frequency of resonance is increased, the concentration of flux lines is reduced due to the lower Q.

The above qualitative description can be helpful in visualizing what is happening from a conceptual point of view and in providing an understanding of what is going on with this feed method.

The equivalent xfmr turns ratio n between the tuned loop and the matching loop is merely the ratio of their respective enclosed areas A which is the ratio of the amount of flux coupled from the large loop to the small feed loop. If both loops are circular with diameters D_c and D_m we then have the impedance transformation at resonance defined by the following relationship:

$$R_p/R_{in} = n^2 = [A_c/A_m]^2 = [D_c/D_m]^4$$

For $R_{in} = 50 \text{ Ohm}$, $D_c/D_m = 5.3$

In practice coupling reduces when the matching loop is moved away from the tuned loop conductor towards the loop centre. Coupling is also reduced if the match loop wire diameter is reduced.

Typically the frequency invariant parallel equivalent radiation resistance R_p of the resonator loop is circa 40k Ohms for practical loaded Q values in the range 250 to 400. R_{in} is 50 Ohms.

$$R_p = [XL]^2/R_s = [2\pi fL]^2/R_s = XL.Q$$

R_s is the loop's series radiation resistance, and the above series to parallel transformation applies. The loop's small radiation resistance is transformed from its original position in series with the inductor L to be across the tuning capacitor C . The remarkable thing is that R_p turns out to be almost constant because the series radiation resistance R_s varies as the square of frequency.

Now not only is the R_p resistance invariant with frequency it is also invariant if the loop size is scaled up or down. The loop inductance is directly proportional to loop size and the radiation resistance increases as the square of the loop size; thus these two variations cancel out in the above equation leaving R_p virtually constant...remarkable.

Yet another convenient consequence of the invariance of R_p is that it's possible to relate the voltage on the tuning capacitor directly to the antenna input power. We have for $V_{cap} = \text{SQR}[R_p \cdot W] = 200 \text{ SQR}[W]$ thus for 1000 Watts input $V_{cap} = 6324$ Volts RMS irrespective of frequency or loop size when assuming no losses. A current calculation is presented on Page 10.

If one seeks small loop mode purity and figure-8 pattern symmetry with deep side nulls for local noise rejection on Rx, the fully balanced Faraday transformer coupled subsidiary broadband impedance matching loop with its 5:1 diameter ratio would be the preferred choice of feed structure. Figure 4 below illustrates the construction of the Faraday feed loop. Mounting rigidity is achieved with the use of either RG-213 or LDF4-50 heliax for constructing the feed loop.

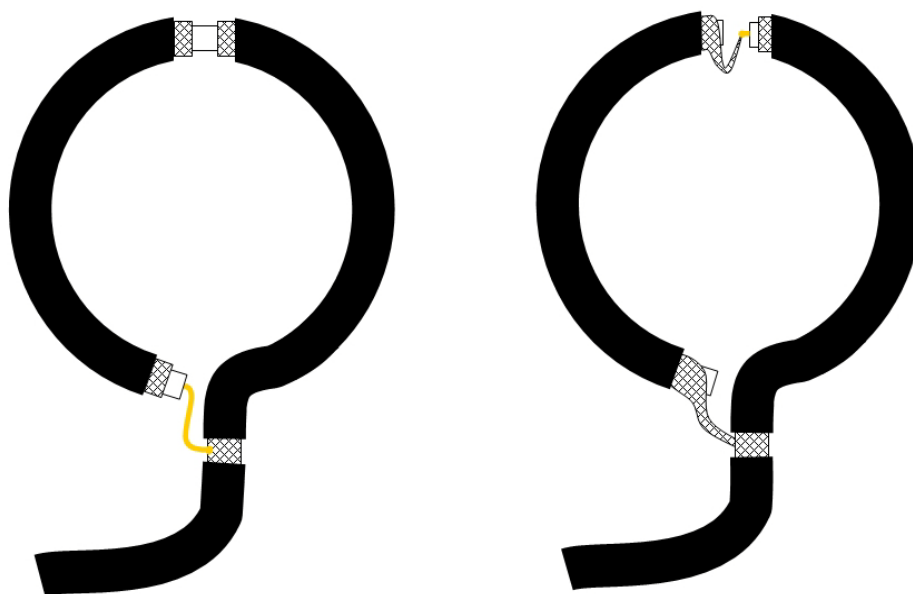

Figure 4 Alternative constructions for shielded Faraday loop

A variation of the shielded / Faraday feed loop is the simpler unshielded loop illustrated below in Figures 5 and 5A while Figure 5B shows the MLA equivalent circuit. The loop is placed at the bottom centre directly opposite the top side tuning capacitor with the coax outer braid optionally connected to the main loop at its central neutral point. The diameter is again 1/5 that of the main radiating loop element.

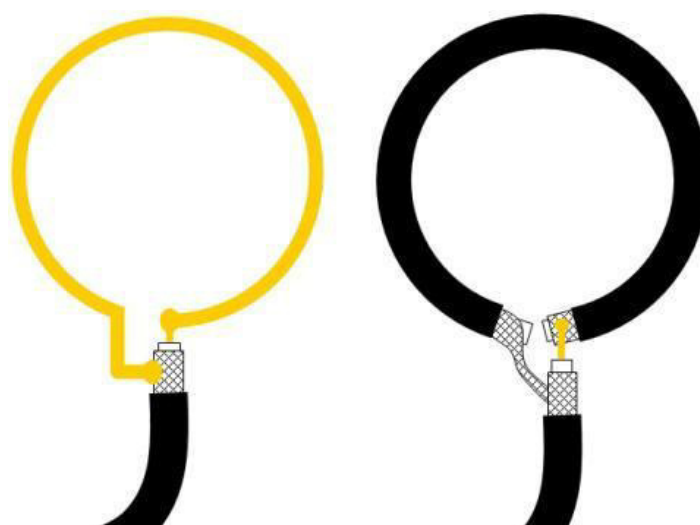

Figure 5 Unshielded coupling loop



Figure 5A Unshielded coupling loop

The common-mode impedance of a symmetrically made small balanced loop structure with symmetrically placed tuning capacitor tends to be high and the associated common-mode current tends to be small. For effective choking this implies the CM suppression choke impedance be made very high, many k-Ohms by parallel resonating the choke inductance by parallel capacitance across the coax braid as it enters and exits the ferrite sleeves.

Loop balance is important for rejecting local man-made electric E-field conveyed noise; whereas the small loop is predominantly H-field responsive, any electrical imbalance results in unwanted common-mode currents flowing on the feeder that can skew the radiation pattern and impart deleterious E-field sensitivity which may contribute to additional local noise pickup. These extraneous feeder currents can be readily choked-off and eliminated with a ferrite core balun common-mode choke as conceptually illustrated in Figure 6.

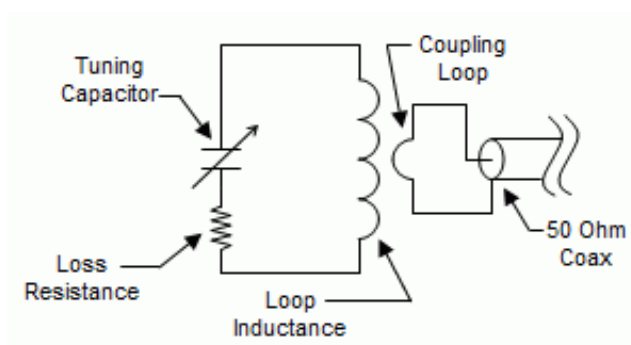

Figure 5B MLA equivalent circuit

In Figure 5B above the equivalent circuit component labelled “Loss Resistance” represents the combined summation of all intrinsic antenna dissipative losses and the external contributing losses from coupling to ground and proximate objects located within the antenna’s near-field.

In series with this loss resistance is the non-dissipative loop radiation resistance R_r (not shown). It is instructive to consider the loop circulating RF current I_{cir} with say 400 Watts applied power. With a typical combined $R_r + R_{loss}$ as low as 120 milli-Ohm, $I_{cir} = \sqrt{P/R} = \sqrt{400/0.120} = 58$ Amperes. At an input power level of 1 kW the antenna RF circulating current rises to a very substantial 90 Amperes! This current level has substantial implications for the capacitor rating.

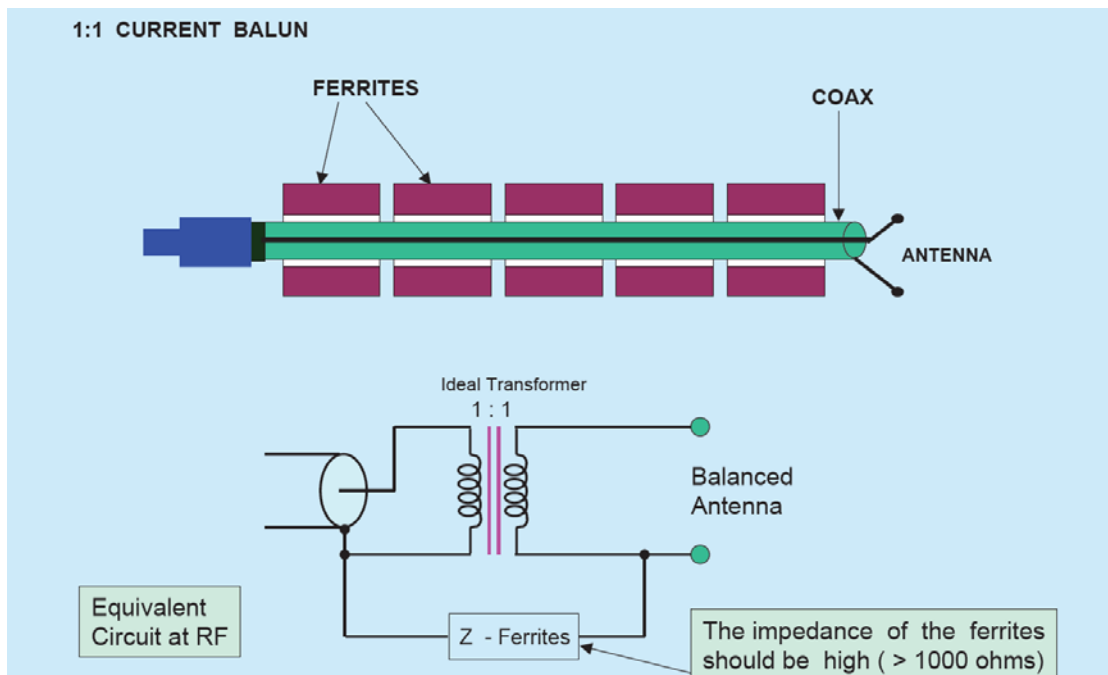

Figure 6 Common-mode current choke / balun



Figure 7 Multi-turn high power common-mode choke balun

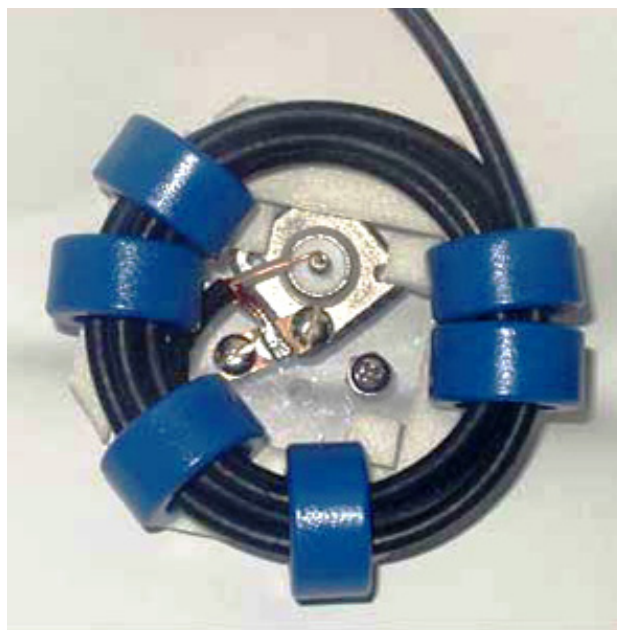

Figure 8 Simple common-mode suppression choke construction

The various coaxial balun choke configurations depicted in Figures 7, 8, and 9 use Amidon or equivalent ferrite mix 43 ($\mu = 850$) or mix 61 for the toroid core stack and are placed in the coax feedline nearby where the coax interfaces to the loop.



Figure 9 Alternative common-mode choke construction

The Gamma match method is illustrated below in Figures 10, 11, and 11A. It is basically a tapped auto-transformer with the coax feed braid connected to the loop's central neutral point and the centre conductor connected via the concentric adjustable Gamma tube to the point on the loop conductor where the voltage to current ratio matches 50 Ohm. There is some inherent loop imbalance and asymmetry imparted with this arrangement and slight radiation pattern skewing is one of the consequential trade-offs associated with a Gamma feed compared to that obtained with an auxiliary Faraday loop matching or current transformer feed.

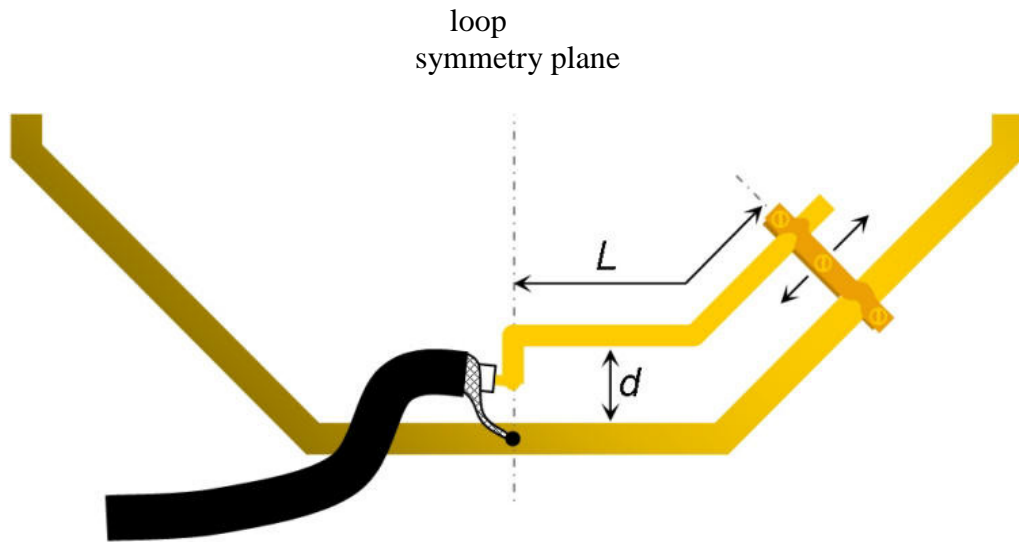

Figure 10 Asymmetric Gamma match

The above geometric parameters and the sliding shorting strap are juggled empirically to achieve a perfect 1:1 VSWR at loop resonance that holds up over at least 2:1 loop tuning range.

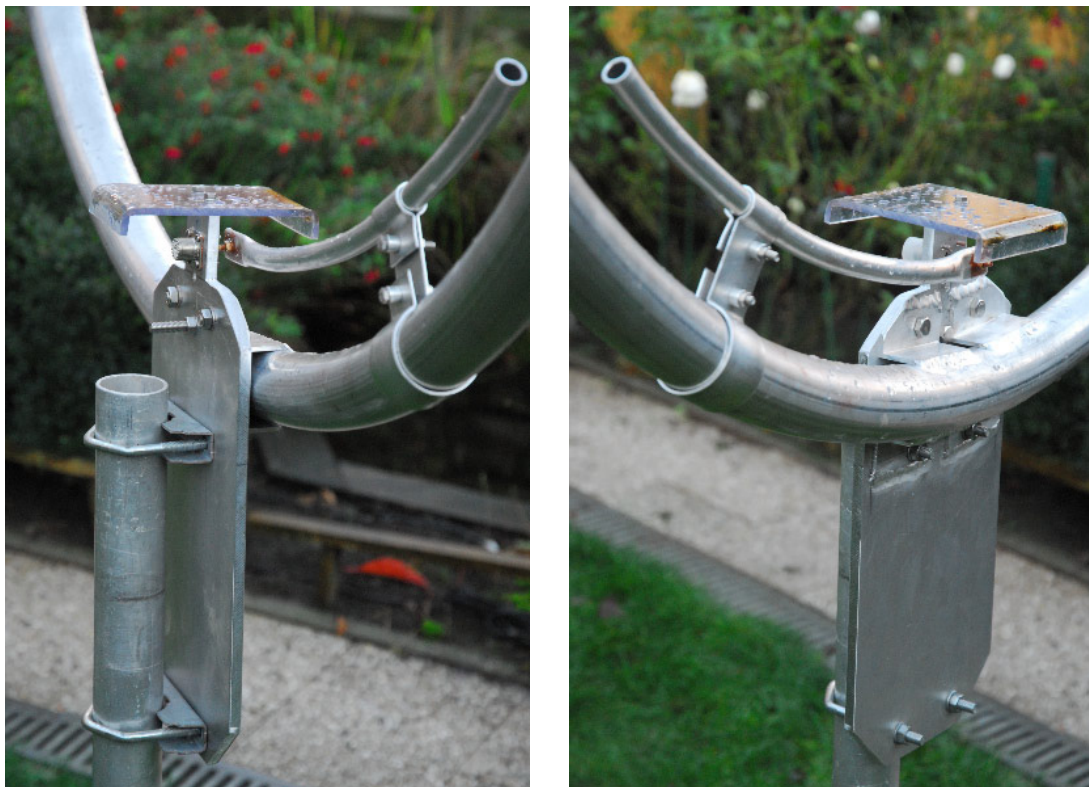

Figure 11 Gamma feed implementation technique

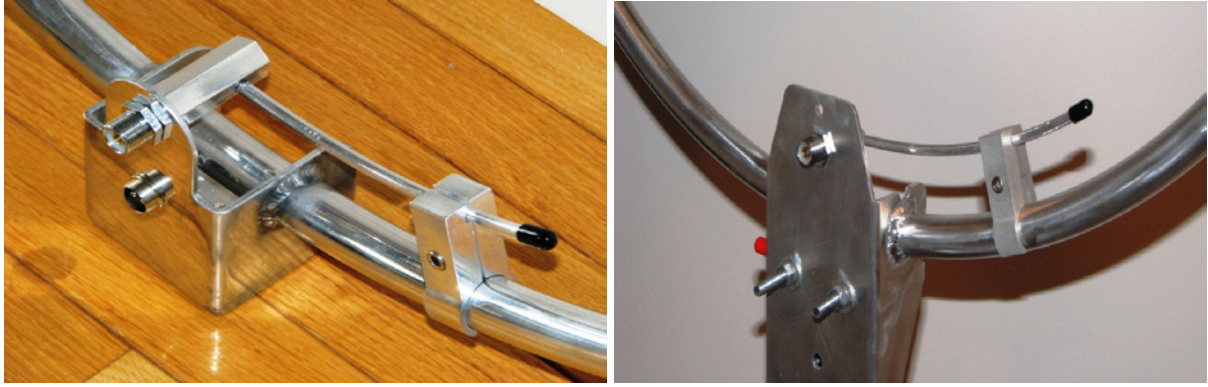

Figure 11A Adjustable Gamma feed implementation technique

When a current transformer feed method is deployed one must of course endeavour to match the sum of the loop's radiation resistance R_r and *total* loss resistance R_{loss} to the 50 Ohm feed coax. The latter efficiency determining loss resistance value typically greatly dominates R_r when excessively small diameter/circumference loops in respect to the wavelength are contemplated. Depending on the loop's size and operating band, the loop feed impedance may be as low as 50 to 100 milli-Ohm, thus requiring an impedance transformation ratio of circa 1000 to 500, or a turns ratio N of 30:1 to 22:1. The "one" in this ratio is simply the loop tubing conductor passing through the centre window of the toroid core.

There are several contributing components to the systemic resistance R_{total} we seek to match.

$$R_{total} = R_r + R_{loop} + R_{ground} + R_{capacitor}$$

Where R_{loop} is the RF skin effect loss in the loop conductor, R_{ground} is the induced ground loss, and $R_{capacitor}$ is the ESR loss resistance of the loop tuning capacitor. The value of R_{total} can be estimated from an in situ measurement of the antenna Q with a VNA or antenna analyzer.

$$R_{total} = 2\pi f L / Q \text{ where } L \text{ is the loop's self-inductance}$$

The idea of using toroidal current transformer / CT feed matching located at the loop's bottom symmetry plane / electrically neutral point is a neat solution providing one can facilitate a high near-unity coupling coefficient k so as to minimise deleterious primary winding leakage inductance; the consequence of too high a value reducing the effective turns ratio in a manner not easily calculated. As the xfmr turns ratio is fixed in order to achieve the requisite impedance transformation, the only available xfmr parameter to optimise k is the magnetic flux coupling volume / cross-section area of the ferrite core...which needs to be rather substantial; some stacked toroids will help here to ensure tight coupling and QRO power handling.

A ferrite toroid such as Amidon FT-140-43 (ID = 23 mm) FT-240-43 (ID = 35 mm) is fitted over the loop conductor directly opposite the tuning capacitor as illustrated in Figure 12 below. The multi-turn primary winding has the appropriate number of turns to match the loop to the 50 Ohm feeder. The loop conductor is effectively its own single-turn secondary winding. For proper operation one must ensure the core permeability μ is high enough to yield a primary reactance of greater than twice and preferably 5X the feedline impedance while the core material must have a low hysteresis loss at the operating frequency. Ferrite mix 43 with a μ of 850 satisfies this requirement. This simple feed method works very well at the 100 to 200 Watt drive level when the evenly distributed primary turns are wound with 1.5mm^2 PVC insulated copper wire.

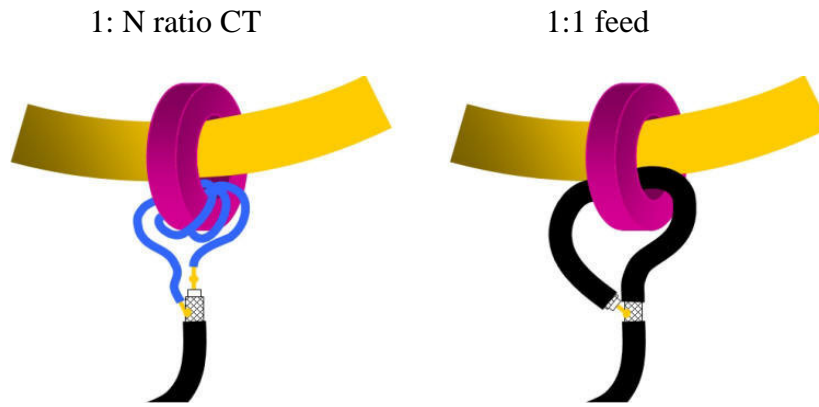

Figure 12 Conceptual and practical realisation of transformer coupling

An interesting variation depicted in the top right hand side of Figure 12 is the 1:1 transformer comprising a one-turn loop of the feeder coax threaded through the toroid core. This arrangement effectively places the $50\ \Omega$ impedance of the coax feed line in *series* with the very low fractional-Ohm impedance of the loop and can result in some mismatch losses. However the more precise multiple N winding CT technique yields the better result.

Loop pattern and radiation characteristics

The small loop with its doughnut shaped pattern exhibits a typical gain of 1.5 dBi over average ground and a gain of about 5 dBi when deployed with either short radials (the length of each radial need only be twice the loop diameter) or mounted over a conductive ground plane surface.

By comparison a large $\frac{1}{2}\lambda$ horizontal dipole mounted $\frac{1}{4}\lambda$ above average ground has a gain of 5.12 dBi and a $\frac{1}{4}\lambda$ Vertical with 120 radials each $\frac{1}{4}\lambda$ long has a gain of 2 dBi over average ground. The front to side ratio of a well balanced loop is typically 20 to 25 dB when care is taken to suppress spurious feeder radiation due to common-mode currents flowing on the coax braid. There is a gain difference comparing a loop with a dipole as the dipole has directional gain and the horizontal orientated loop has an omni-directional pattern.

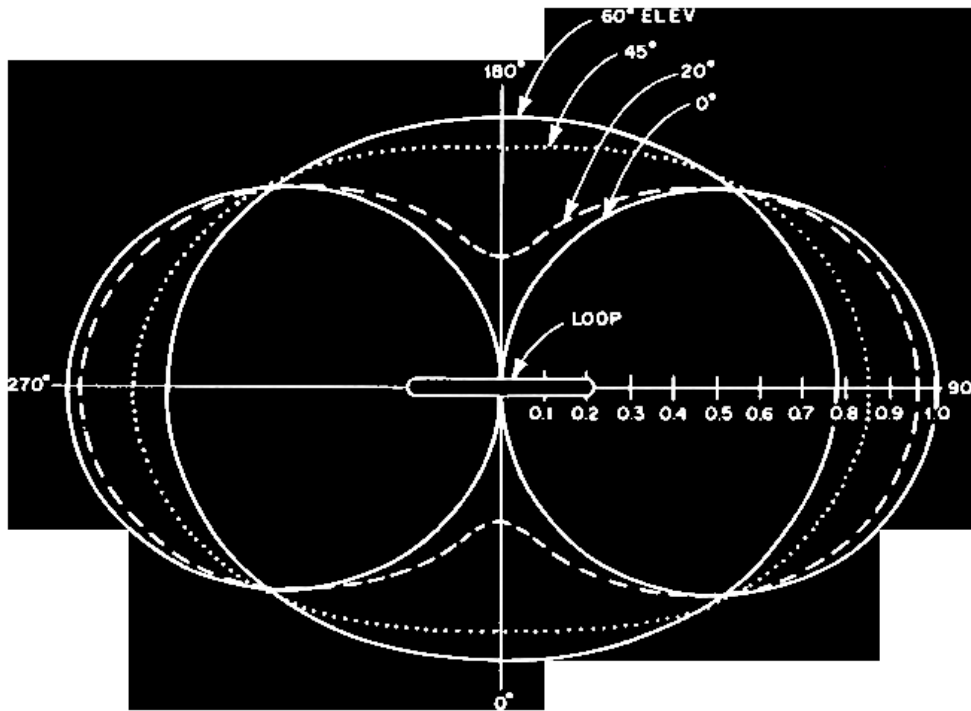

Figure 13 Loop radiation pattern

However the small loop (circumference less than one-third wavelength) has one very significant advantage over any other antenna due to its unique radiation pattern illustrated in Figure 13. If the vertically oriented loop's figure-8 doughnut pattern radiation lobe is visualised standing on the ground the maximum gain occurs at *both* low and high angles, radiating equally well at all elevation angles in the plane of the loop, i.e. radiation occurs at all vertical angles from the horizon to the zenith. Because the loop radiates at both low and high angles, a single loop can replace both a horizontal dipole and a Vertical. This is particularly beneficial on 160, 80 and 40m where the loop will provide outstanding local / regional coverage and easily match and often outperform a tall $\frac{1}{4}\lambda$ Vertical for long haul DX contacts, i.e. an exceptionally good general purpose all-rounder antenna.

The salient characteristic of the small MLA radiation pattern is its maximum in the plane of the loop; this is in stark contrast to the radiation maximum being perpendicular to the plane of a large loop having a one-wavelength circumference wire that's popular with many radio hams.

Energy radiated by the small loop is vertically polarised on the horizon and horizontally polarised overhead at the zenith. It will be quickly realised that a loop has the distinctive property of providing radiation for transmission and response for reception over both long distances and over short to medium distances. This is achieved by virtue of low angle vertically polarised propagation in the former case and by means of horizontally polarised oblique incidence propagation in the latter case. In contrast, a Vertical monopole is useful only for low angle vertically polarised propagation since it exhibits a null overhead and poor response and radiation at angles in excess of about 45 degrees. Such antennas are of course very useful for long distance communication by means of low angle sky wave skip propagation, or for short range communication via the ground wave propagation mode.

In further contrast, a horizontal $\frac{1}{2}\lambda$ dipole (or beam arrays comprising dipole elements) at a height above ground of a just a fraction of a wavelength (as opposed to idealised free space or mounted very high) exhibits maximum polar response directly overhead (good for NVIS) with almost zero radiation down near the horizon.

Such popular “cloud warmer” antennas in residential situations as the surreptitiously low hung ubiquitous G5RV, End-feds, dipoles, inverted-V, etc. are thus most useful for short to medium range communication in that portion of the HF radio spectrum where oblique incidence propagation is possible.

Importantly it should be noted that when comparing small loops with conventional antennas a 20m Yagi beam for example must ideally be deployed at a height above ground of at least one wavelength (20m) in order to work well and achieve a low take-off angle tending towards the horizon for realising optimal no compromise long-haul DX operation. If the beam is deployed at a low sub optimum height, the MLA will outperform it. This is an eye-opener surprise to many folk!

Unfortunately such an ideal tower height is impractical in most residential zoning rule situations imposed by municipal councils, HOA, CC&R, and town planners. If the Yagi beam is deployed at a lower 10m height then a diminutive loop will nearly always outperform the beam antenna. This writer never fails to be amused by folks who acquire a potentially high performance Yagi HF beam and sacrilegiously deploy it in suboptimal installations in respect of height above ground or proximity to a metal roof. The problem worsens on the lower bands below 20m where the resultant high angle lobe pattern direction due to low antenna height is not at all very conducive to facilitating good DX communication.

In comparison to a vertically mounted / oriented loop, the bottom of the loop does not need to more than a loop diameter or so above typical ground making it very easy to site in a restricted space or low visual impact location / HOA or CC&R regulated area. The capability that a small sized MLA can provide may be the difference between enjoying HF ham radio and giving it up.

There is no significant improvement in performance when a small loop is raised to great heights; all that matters is the loop is substantially clear of objects in the immediate surrounds and the desired direction of radiation! Mounting the loop on a short mast above an elevated roof ground-plane yields excellent results.

A good HF antenna for long haul DX propagation paths requires launching the majority of the Tx power at a low angle of radiation; things a good, efficient and properly installed vertical, a properly sited small magnetic loop, and a big multi-element beam atop a very tall tower do very well. Of course the latter beam antenna has a forward gain and directivity advantage over the loop that may be helpful on some weak signal paths.

Small loop antennas have at least two simultaneously excited radiation modes; a magnetic and an electric folded dipole mode. When the ratio proportions of loop mode and dipole mode radiation are juggled to achieve equal strengths some radiation pattern asymmetry results and a useful degree of uni-directionality can be achieved with a typical front to back ratio of about 6 dB or so. Such pattern asymmetry skew can also result when the feeder coax has common-mode currents that contribute supplemental radiation.

Receiving properties

In a typical high noise urban environment a loop will nearly always hear more than a big beam on the HF bands. The small magnetic loop antenna (a balanced one) responds predominately to the magnetic component of the incident EM wave, while being nearly insensitive to the electric field component; which is the basic reason why loops are so impressively quiet on receive; often times dramatically so. They will pull in the weak signals out of the ambient noise and you will very likely receive stations that you'd never hear when switching across to a vertical, dipole or beam antenna deployed in high density suburbia plagued with copious man-made noise.

In a propagating radio wave the magnitude of the electric vector is 120π or 26 dB greater than the magnitude of the magnetic vector, the difference being due to the intrinsic impedance of free space (377 Ohms).

On the other hand the induction fields associated with man-made noise have electric E-field components many times greater than a normal radiation field (radio wave). While a dipole or vertical antenna is sensitive to both the electric and magnetic components of a wave, the small loop is responsive only to the magnetic H-field component and it will be substantially “blind” and offer a high degree of rejection to pickup of undesired man made noise and propagated atmospheric disturbances.

Hence the widely used term “magnetic loop” antenna to signify this field discrimination to the components of the incoming incident EM wave. Antenna theory treats the loop as the electrical conjugate of the dipole, i.e. the loop is a “magnetic dipole” while an ordinary dipole is an “electric dipole”.

Significantly, a small loop antenna will typically produce a signal-to-noise ratio / SNR that is some 10 to 20 dB greater than a horizontal dipole in a noisy urban environment and an even greater improvement in SNR when compared to a vertical antenna as a result of the man-made noise comprising a strong electric field component and being largely vertically polarised. The SNR determines readability, not the received signal strength per se. The missing strength can be returned noiselessly by the receiver’s AGC system.

The most important criterion for reception is the signal to noise ratio and *not* antenna gain or efficiency. In the HF band, particularly at the low-mid frequency portion, external man-made, seasonally and solar cycle variable galactic / atmospheric noise is dominant.

The transformer analogy for the loop antenna is a good one. The HF communication link may be visualised as a reciprocal “space transformer” with the Rx loop acting as a secondary “winding” very loosely coupled to the distant transmitting antenna. The magnetic field component of the incident electromagnetic wave induces a small RF current to flow in the loop conductor by means of induction that in turn gets magnified by the loop resonator’s high Q that’s appropriately impedance matched to the coax transmission line.

The magnetic loop antenna has one other important practical advantage in receive mode. The aforementioned high-Q resonator imparts a very narrow band frequency selective bandpass filter ahead of the Rx front-end stages. Such an incidental preselector comprising the antenna itself imparts greatly improved receiver performance on the congested lower HF bands with high power broadcast stations and particularly when lightning strikes and atmospheric electrical discharges are present in the regional area. Unwanted overload causing and adjacent-channel QRM interference signals are rejected or heavily attenuated.

As well as eliminating strong-signal overload and intermodulation effects, the filtering dramatically reduces the amount of lightning induced broadband impulse energy fed to the Rx front-end and weak signals can still be heard when reception under such adverse conditions was previously impossible with other antenna types.

It is these collective characteristics of small loop antennas that enable them to often very significantly outperform their large dipole, Yagi or Quad beam counterparts during direct A/B comparative testing. Conversely in Tx mode the antenna’s inherent filter action selectivity causes any transmitter harmonics to be greatly attenuated and not radiated. This can help with eliminating some forms of TVI and BCI.

Some words about efficiency and losses

Efficiency of any antenna is defined as the ratio of power radiated to the total power applied to the antenna and is represented by the following expression.

$$\text{Efficiency \%} = R_r / (R_r + R_{\text{loss}}) \times 100 = 100 / (1 + R_{\text{loss}}/R_r) = R_r / R_{\text{total}}$$

From the MLA equivalent circuit of Figure 5B the radiation resistance R_r and the total effective loss resistance R_{loss} are in series and when the antenna is resonant the total power is applied to the sum of these two resistances. Only the former contributes to wanted radiation.

It is interesting to note the way in which the input power divides between the loss and radiation resistances. The assumption is the power splits in the ratio of these two resistances, but that is not quite correct when the loss resistance is substantially greater than the radiation resistance; under this circumstance part of the received power is dissipated in the loss resistance and not passed to the receiver. Correspondingly on transmit the radiation resistance is not correctly matched as it sees a load that is the parallel combination of the load resistance and the very nearly equal loss resistance. In either case the power passed to or from the radiation resistance is reduced by up to 3 dB. This means the MLA efficiency is not quite what it seems.

As with most antenna systems departure from perfect electrical symmetry will result in currents flowing in parts of the system and ambient surrounds where no currents should flow. Such extrinsic factors can add to the total system loss. Losses attributed to the unpredictable environment are the most difficult to deal with as isolating the loop from ground and its electrical environment is virtually impossible at the low HF bands. This includes common mode currents flowing on the outer braid of the coax feed cable and currents induced on adjacent conductor objects such as pipes, roof guttering, fencing, and electrical cables, etc in nearby proximity to the loop antenna. When the MLA is placed over ground both R_r and R_{loss} will increase since ground is an imperfect reflector having some loss due to transformer effect coupling RF energy into the lossy material.

Since however the MLA already has a very low radiation resistance due to mutual coupling within itself additional external coupling to the nearby lossy ground has only a moderate effect on efficiency. With poor soil conditions a good quality reflector plane or wire radial mat under the loop will improve performance. An image is formed that effectively doubles the area of the loop and since R_r increases as the area squared doubling the area increases R_r by a beneficial factor of 4 and thus swamps R_{loss} .

Efficiency is influenced by some radiated RF energy being captured or absorbed by objects in the proximity of the loop, e.g. energy absorbed by ferrous materials like iron and steel contribute significant Eddy current and hysteresis losses, as does other Q damping conductor materials.

Efficiency is also a function of the earth's soil conductivity. Even though an STL antenna does not require radials or a ground plane, once the RF energy is radiated it is still subject to the same laws of radio physics that all other types of RF radiators experience. Better earth conductivity usually results in more of the vertically polarized signal being reflected (in the far field, not in the near field), thus combining with and reinforcing the direct-path signal at the desired lower elevation angles of radiation.

Vertical orientated small loops may provide up to twice the signal strength under certain conditions when operated near a highly reflective surface or earth surface, such as salt water. This is why a vertical loop is very special, and, as a bonus, it does not have the disadvantage of overhead nulls in the antenna pattern like verticals and short whip antennas have.

When the loop conductor length approaches 0.25λ or so the STL achieves maximum efficiency. This corresponds to the largest VSWR bandwidth and the lowest voltage across the tuning capacitor due to the higher radiation resistance and associated lower Q. As we increase loop conductor length towards self-resonance the loop's folded-dipole (first-order) mode and its associated higher radiation resistance becomes very appreciable and predominates. This additional radiation mode to the normal loop (zero-order) mode occurs on the higher HF bands. The loop's dipole mode is excited by the voltage which appears across the capacitor when power is transformer coupled into the tuned loop from the subsidiary feed loop, gamma feed. In this respect the term "magnetic loop" is arguably somewhat of a misnomer.

We can note that MLA efficiency improves as the frequency is increased with the proportion of loss decreasing proportional to the inverse square root of frequency. This implies that the use of a fatter tube diameter conductor becomes less important at the higher HF band frequencies.

Finally it is interesting to compare the efficiency of the MLA with a large half-wave HF dipole. The latter has a high radiation resistance of circa 60 to 70 Ohms and can readily achieve a high efficiency approaching 100% if the loss resistance of the dipole element wire is negligibly small compared to 70 Ohm (easy to achieve). This contrasts greatly to the MLA scenario.

Effects of ground on loop antenna performance

When a dipole antenna is placed horizontally above ground, its electrical image in the ground is of the opposite phase. As a consequence, if the height above ground of a horizontal dipole is reduced to less than $\frac{1}{4}$ wavelength, fairly high system losses develop due to a rapid decrease in radiation resistance concurrent with a rapid rise in loss resistance resulting from dissipation of power within a less than perfect ground. This represents a classic double-whammy scenario and deleterious performance for dipoles deployed at insufficient height above ground (a widespread limitation for many ham radio antennas).

By way of contrast, the oscillatory RF currents associated with the image of a small vertical oriented loop antenna above ground are "in-phase" with those of the loop. Therefore the effect of ground on the performance of a vertically oriented loop is relatively small. In fact, because the magnetic component of an electromagnetic wave is maximum at the boundary between the ground and the space above, loop performance is usually best when the loop is located near the ground at a distance outside of the loop's close-in induction field (just a loop diameter or two).

However, if nearby conductive objects such as power lines or building structures exist in the direction of transmission / reception; it is normally preferable to choose a height above ground which will provide the loop with a clear and unobstructed view of the intended signal path.

In comparing the performance of a vertical whip and a small vertical loop located atop of a building, it may be said that the loop will generally be the clear winner with respect to vertical and horizontal radiation patterns. This is because the pattern of a whip antenna driven against the top of a building is usually not predictable with any accuracy at all because vertical currents will flow all the way up and down the several conductive paths between the antenna and the earth; each path contributing to the total radiation pattern in the form of multiple lobes and nulls.

A balanced loop antenna, however, is inherently immune to such problems because the ground below the antennas does not form the missing half of the antenna circuit in respect of supporting ground-return currents as it does with a vertical whip / monopole antenna. Therefore the multiple current paths to ground (earth) are eliminated with the loop. Of course both the loop and the whip are subject to the well-known wave interference effects in elevation due to height above the ground (or water).

Reflective metal objects having a size greater than about 1/3 of a wavelength and at a distance of less than about 2 wavelengths from the loop antenna can produce standing wave “nulls” in a given direction at various frequencies. If the antenna is to be mounted atop a metal roof, diffraction interference from the edge of the building roof should be considered if undesirable nulls in certain directions at some frequencies are to be avoided. Usually the best antenna siting location is near the edge of such a conductive roof, in the direction of the desired signal or signals.

Whereas vertically oriented loop operation over good ground is more efficient than over poor (lossy) earth, this is far less critical than with verticals and small whips tuned and fed against earth or artificial ground plane. In the latter vertical case the attainable antenna efficiency is wholly dependent on the quality of the ground plane system and radial mat.

Loop Pattern and Directivity

It is commonly believed that a vertically oriented loop antenna exhibits a bi-directional pattern with maximum reception occurring in the plane of the loop. Although this is true for vertically polarised sky-wave signals arriving at very low elevation angles (less than about 10 degrees) and for ground-wave signals, it is certainly not true for reception of high angle sky-waves (greater than about 30 degrees) whose polarisation usually rotates from vertical to horizontal at a fairly random rate due to “Faraday Rotation” of free-electrons within the ionosphere.

At signal arrival angles exceeding 45 degrees, the loop response shifts to a preference for horizontal polarisation arriving at an azimuth angle of 90 degrees with respect to the plane of the loop. Thus, for short-range communication links, i.e. less than about 500 km, best reception will usually occur with the loop rotated 90 degrees, that is, the plane of the loop perpendicular to the azimuthal arrival angle.

It is not easy to predict which azimuthal bearing will provide the best night-time reception with a loop over paths of less than about 500 km at frequencies of less than about 7 MHz. This is due to the prevalence of both sky-wave and ground-wave signals which randomly combine to produce rather serious fading. Usually, trial and error is the best solution for determining which antenna orientation will produce the most favourable compromise between the highest average signal-strength and the least troublesome fading. Generally for distances exceeding 500 to 1000 km, the best orientation is with the plane of the loop in the direction of the arriving signal.

Further, the side nulls exhibited by the loop at low elevation angles may be used to “null-out” the ground-wave signal to reduce fading when sky-wave propagation exists simultaneously. In comparison a vertical whip has a null overhead and thus is ineffective for communication over short and medium distances.

A vertical loop antenna located less than about 0.15λ above ground exhibits excellent coverage from the zenith down to almost zero degrees in the elevation plane making the loop useful over almost any distance range. At elevation angles higher than about 20 degrees, a loop is almost omnidirectional in azimuth when receiving sky-wave signals.

For a loop above average ground (conductivity 5 mS/m and dielectric constant 13), as opposed to ground having perfect conductivity, the response at very low vertical angles e.g. less than about 5 degrees, is typically 10 dB or more below the achievable response above perfect ground. It is perhaps worthy to note that the ground immediately below the loop principally affects the response at high vertical angles while the properties of the ground at a large radius distance from the antenna tends to define and characterise the performance of the loop at low vertical angles in the plane of the loop.

The desired radiation pattern depends on frequency and path length. For the HF bands above 10 MHz low-angle sky-waves are the general requirement. For the lower 160, 80 and 40m bands high-angle sky wave is a common requirement with the exception of those wishing to work low band DX. For an MLA deployed near ground with its plane oriented vertically the total azimuthal pattern resulting from the combination of the vertically and horizontally polarized fields emanating from the loop is omni-directional at high elevation angles. The sky-wave polarization is vertical as the dominant magnetic component is parallel to the ground.

When the MLA is mounted horizontally, i.e. parallel to the ground, the polarization for the sky wave is horizontal and the azimuthal response is omni-directional. Then as with any horizontally polarized antenna the take-off angle will depend on the height of the antenna above ground. As height increases the gain increases and the take-off angle decreases so for good DX operation the horizontal MLA should be mounted as high as possible as it should be with any conventional dipole or Yagi antenna. Such practical horizontal loop deployments are feasible with elevated storey condominium balcony or rooftop overhang mounts (see Figure 22). Impressive gain and low take-off angle are achieved yielding exceptionally good results from the MLA.

The exception is the case of salt water in the direction of propagation where vertical polarization can be used very effectively. The vertical oriented loop's polar response at very low elevation angle close to the horizon is far superior to the much higher mounted horizontal antenna. This is the reason why the vertical MLA is an excellent choice for shipboard nautical HF operation.

When a land based MLA is deployed above practical good to average ground with finite conductivity there is, characteristic of vertical polarization, pattern cut-back at the low elevation angles making it difficult to launch low-angle sky-waves below about 10 degrees. Consequently there is little advantage deploying a vertical oriented MLA high above the ground, other than to clear local environmental obstructions.

MLA construction issues

Without a good quality low-loss split stator or butterfly variable or vacuum variable capacitor of adequate RF voltage and current rating, it is quite futile building a magnetic loop antenna and expecting it to yield the impressive results that it is potentially capable of. The minimisation of all contributing sources of ohmic loss is particularly important in Tx mode. TIG welded vanes and fillets of weld on the spacer stack on an aluminium split-stator or butterfly air variable lowers the capacitor's distributed ohmic loss resistance or ESR by a significant amount.

By virtue of the shorter rotor, the butterfly style capacitor illustrated in Figures 14 and 15 has slightly lower rotor loss than the split-stator construction style. In either case the two stators are connected to each end of the loop conductor via wide copper or aluminium straps. The tuning capacitor is undoubtedly the single most critical component in a successful homebrew loop project. TIG weld fillets on all of the mating metal-to-metal surfaces of fixed parallel-plate or variable split-stator and butterfly capacitors will ensure the lowest possible ohmic loss accumulation especially over time in the presence of moisture and surface oxidation or corrosion from moist air ingress or water condensation within the capacitor's weather protective housing.

The contiguously connected TIG welded fillets along the entire plate spacer stacks are illustrated in Figure 15. It will also be noticed that the connection of the capacitor aluminium mounting brackets are also TIG welded to the main loop element to ensure very low interface resistance is maintained through the total absence of any mechanical clamped contact joints.

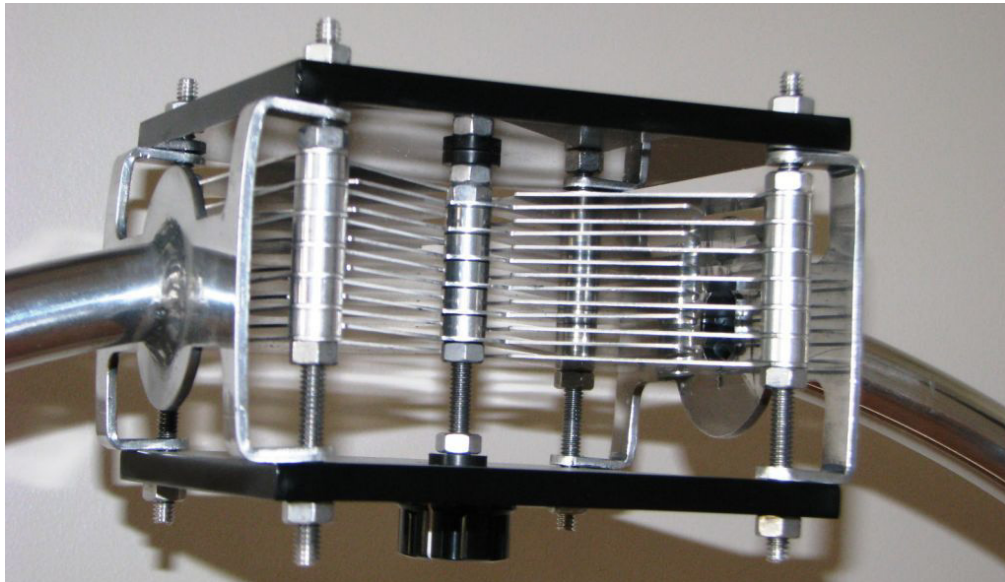

Figure 14 Illustration of Butterfly Capacitor

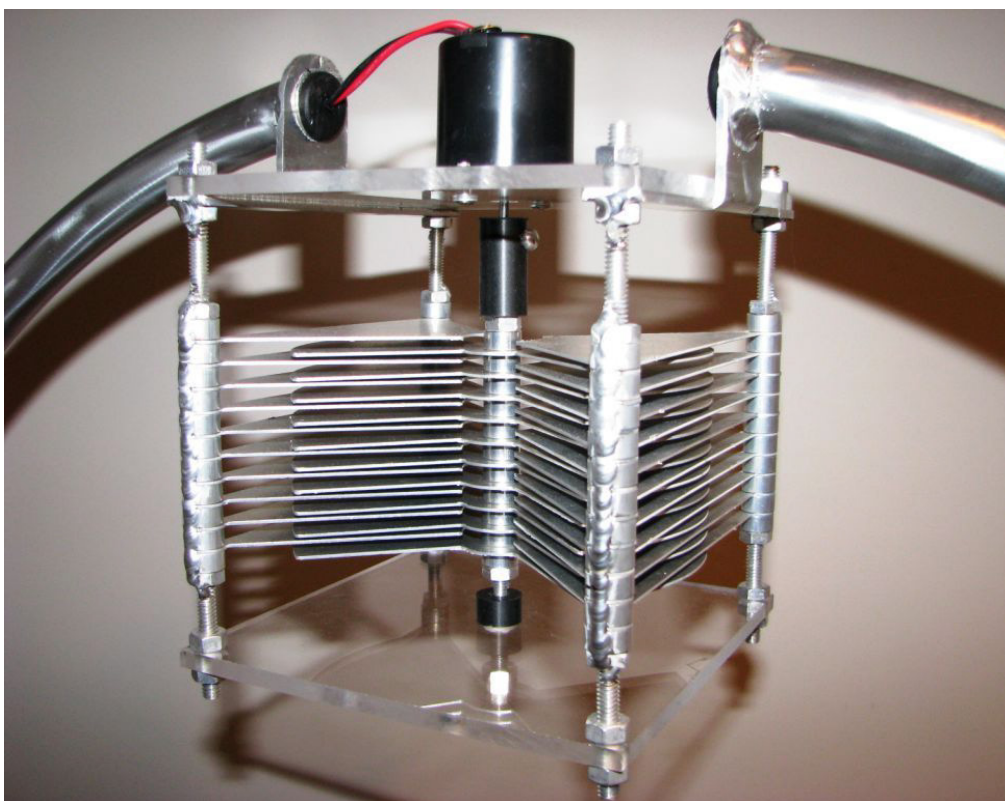

Figure 15 Butterfly Variable Capacitor with Motor Drive

Although more expensive and somewhat harder to find, vacuum variable capacitors have a large capacitance range in respect of their min/max ratio and allow a loop to be tuned over a considerably wider frequency range than that achievable with an air variable capacitor. Vacuum capacitors have lower ESR losses and higher Q than most air variables. High quality Jennings vacuum variable capacitors (Figure 2) and numerous Russian made equivalents (Figures 16 and 17) can be readily found on the surplus radio parts market and eBay, as can their associated silver-plated mounting and clamp hardware to ensure a low contact resistance connection to the loop antenna conductor. A low contact resistance interface having long term electrical stability and integrity is absolutely essential between the capacitor terminals and the copper loop conductor. Eliminating every stray milli-Ohm counts towards achieving highest efficiency!



Figure 16 Homebrew capacitor clamps with silver-soldered copper fittings



Figure 17 Russian Mil-style vacuum variable with integral clamps

Other creative means can also be used to fashion a high VAR rated low-loss capacitor such as trombone, piston, or interdigitated meshing plate configurations. Fixed value homebrew parallel plate capacitors can be constructed from scrap sheet copper and silver-soldered spacers and augmented by a smaller value variable for bandspreading in a mono-band loop. Air is always the preferred dielectric as most other materials have high loss tangents and dissipation factors.

Whether a vacuum or air variable or homebrew capacitor is chosen, their mechanical shafts can be readily interfaced to a reduction gearbox and motor drive to facilitate easy remote tuning of a roof top or covert loft mounted loop.

Figure 18 illustrates an innovative homebrew fixed air dielectric capacitor stack + variable combo capacitor constructed by VK5JST/VK5TR using readily available low-cost materials, incorporating fine vernier bandspread tuning using an adjustable vane on a servomotor driven threaded lead screw arrangement. The dielectric material is a thick slab of polyethylene breadboard sourced from the local supermarket or the XYL's kitchen. The antenna tuning can be manual or automatic based on VSWR sensing and a self-tuning servo system to control the stepper motor drive. Peaking the loop tuning capacitor for strongest band noise on Rx will get the loop antenna tuning in the right ballpark for achieving a low VSWR when the Tx is subsequently keyed up.

Tuning motor control cables should be routed symmetrically with respect to the two halves of the loop and be decoupled and chocked-off with ferrite sleeves immediately outside of the loop area. Routing the cabling up through the inside of the loop tubing and out a small hole drilled in the bottom electrical neutral point of the loop directly opposite the top tuning capacitor is a benign way to keep the control cables shielded and electrically cold with respect to RF. This self-shielded motor control wire technique is illustrated in Figure 15.

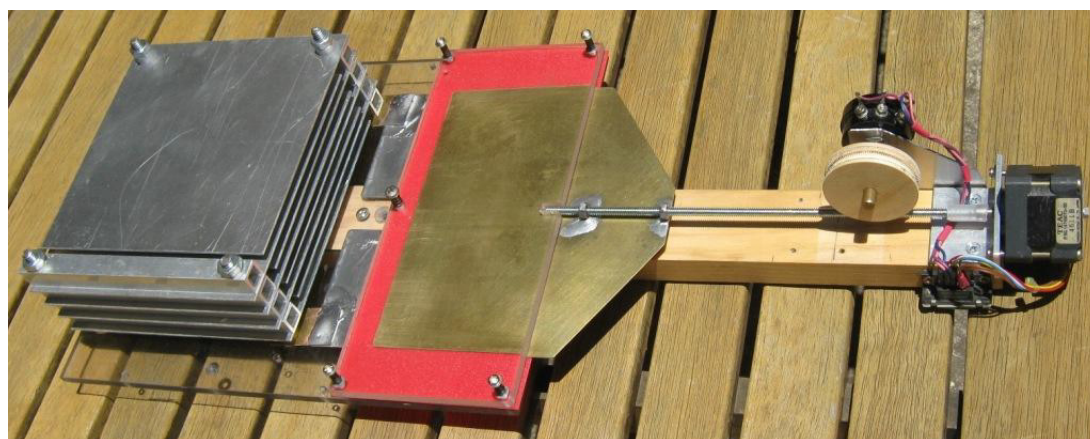

Figure 18 Combo fixed plate + sliding vane vernier bandspreading

Another homebrew capacitor construction method is illustrated in Figure 19 comprising a parallel-plate air variable for tuning a mono-band 20m copper tube loop of nominal 1m diameter. Breakdown voltage and hence power handling level is determined by the air gap spacing of the parallel-plate flap vane capacitor and / or any intervening dielectric material.

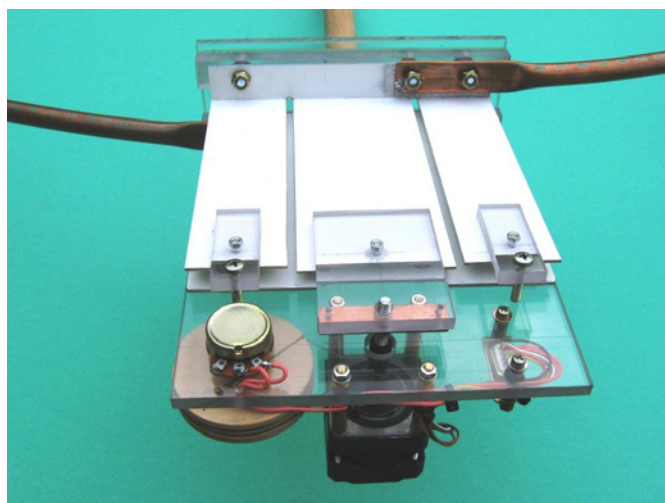

Figure 19 Stepper motor and lead screw driven moving vane air variable

The use of filler-free virgin PTFE is the second best dielectric choice after vacuum and air. Its dielectric strength (V/micron) is about 20x that of air and thus yields a sufficiently high capacitor breakdown voltage to run QRO power. An air dielectric capacitor requires large plate spacing and unwieldy proportions, often impractically so, when a safety margin is considered to run moderately high Tx power in the 500 Watts to 1 kW range. Environmental considerations like humid moist air can seriously de-rate the dry-air breakdown voltage.

Teflon's loss tangent / dissipation factor of circa 0.0002 @ 1 MHz is the best choice of all the other non-air and vacuum practical dielectric options and it's circa 2.1 dielectric constant / permittivity offers a useful reduction in plate area for achieving a given capacitance value in a compact structure with high RF breakdown voltage.

The loop tuning capacitor Q determining dielectric loss tangent is one key parameter; the other is the plate form factor/aspect ratio required to optimally support the very large RF circulating current. If a rotary to linear motion lead screw driven concentric double trombone-style piston capacitor is fabricated the cylindrical pair should be of short and fat proportions to maximize the capacitor plate conductor's surface area supporting the skin-effect dominated RF current flow.

This plate geometry consideration will impact on the desirably high-Q capacitor's ESR / loss. Figure 20 attributed to VE3UK illustrates such successful QRO capacitor construction

You know when your choice of capacitor dielectric is up to the job; it benignly runs cool under steady key-down QRO excitation and does not melt or spontaneously combust. Absence of heating is a good test indicator as the RF input power is ratcheted up on the device under test.

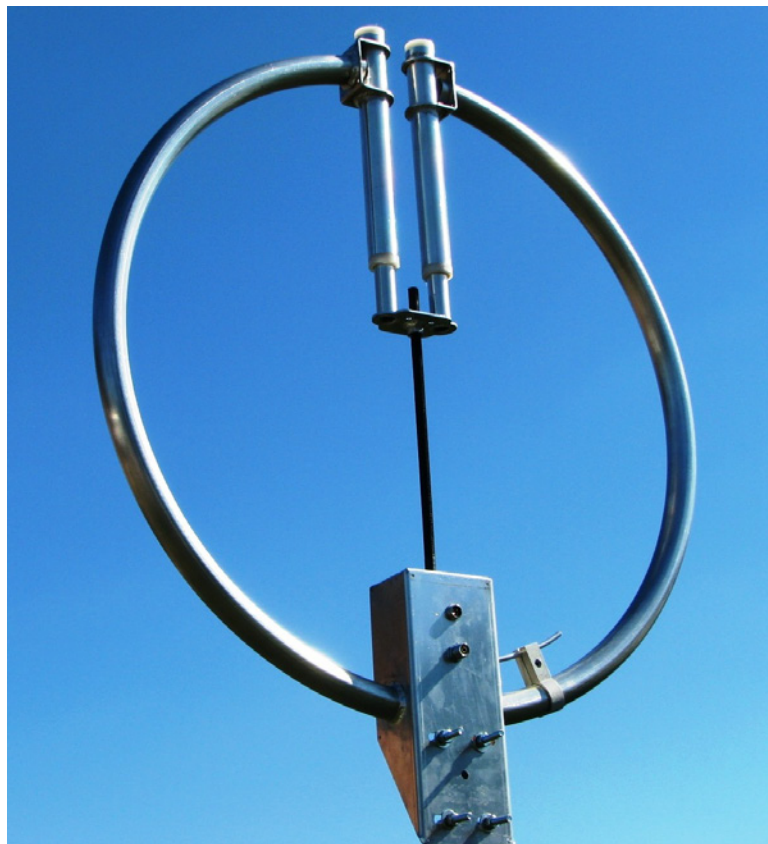

Figure 20 Trombone capacitor tuned loop



Figure 21 Trombone PTFE capacitor detail

Transmitting loop antennas intended for optimal coverage of the most popular portion of the HF spectrum ranging from 3.5 MHz to 30 MHz are best segregated into at least 2 distinct loop sizes. If top-band 160m operation is also required then 3 loop sizes are best.

A nominal 0.9m diameter loop for covering all the upper HF bands from 20m through to 10m (and perhaps also tunable down to 30m depending on capacitor min/max ratio), and a 2m diameter loop for covering the lower bands 80m through to 30m. For best operation down at 160m and improved 80m performance increased loop diameters of 3.4 m to 4 m should be considered. The small loop's radiation resistance and hence attainable efficiency / radiation effectiveness is proportional to the fourth power of its circumferential length; best to err large!

An important operational thing to note about vacuum capacitors is they don't have a uniform RF amperage current rating over their entire capacitance range, but it is less at small plate mesh / their low capacitance end. So one needs to factor this characteristic into design calculations and make sure you operate the capacitor within its current rating over the desired loop tuning range. Manufacturers like ITT Jennings provide guidance nomographs of this RF current data.

This C-I characteristic is another good reason for restricting the loop tuning / operating range over a nominal 2 to 3:1 range so the vacuum capacitor always works in its optimal VAR / RF current "sweet-spot" region. The saving grace with the current ratings of vacuum capacitors is they are continuous RMS Amps, i.e. key-down CW operation; and can be considerably safely exceeded when running relatively low duty cycle SSB voice modes / PEP transmissions. All is OK with vacuum capacitors as long as the rated glass / metal seal temperature is not exceeded. This is unlikely to occur in practice as the silver plated copper mounting clamps efficiently sink and remove heat into the thermal mass of the copper loop conductor.

Mono-band loop operation generally yields the best result as the optimum loop inductance to capacitance ratio can be chosen and the majority of the tuning capacitance can be provided with a fixed-value vacuum capacitor. A much smaller value vacuum variable capacitor can then be deployed in parallel to achieve nice fine vernier "bandspread" tuning across the whole band of interest, e.g. 40m or 80m, etc. This beneficially reduces the tuning sensitivity in terms of the QSY frequency shift vs capacitance change / angular rotation.

Top-band operation at 1.8 MHz is always the hardest challenge for any antenna type, small loops (typical dimensions of 0.02λ) included; but their on-air performance can nevertheless be authoritative with a commanding signal presence. There are no "free lunches" (and few cheap ones) when shrinking the size of antennas as the free space wavelength has not yet been miniaturized by nature redefining the laws of physics! Consequently antennas of such diminutive size must always be placed into proper perspective when compared with the performance attainable from a full-sized $\lambda/2$ horizontal dipole for 160m. However, most amateurs haven't got sufficient residential block size and/or mast height in a fraction of wavelength to accommodate a 160m dipole that works properly with a decent radiation efficiency and ability to put its radiated power in a useful direction. Similarly, reasonably efficient and efficacious Verticals for 160m operation unfortunately exceed the allowed height by a great margin that's permitted by local council and residential building code regulations. Then a huge amount of real estate is required to accommodate the extensive radial system.

The practical on-air performance of a loop on the 160/80m bands will be highly dependent on what antenna you use as a reference comparison, e.g. a centre-loaded mobile whip or full size resonant dipole/monopole, etc. and what path is used, NVIS, ground wave, sky wave, etc. The loop conductor diameter is determined by the desired loss resistance due to skin-effect, and choices can range from modest 6mm copper tubing to large bore 100mm copper or aluminium tube. Commonly used conductor diameters used to construct a magnetic loop are 20mm and 32mm soft copper tube. Heavy wall thickness tubing is not required as the RF current flow is confined to the conductor surface due to the skin-effect. Note that the radiation efficiency is *not* related to the loop size. Loop antenna efficiency is determined by the conductor tube diameter and its electrical conductivity.

This conceptual notion is counterintuitive for many folks. A small loop will also be efficient and radiate power very effectively on 80m and 160m but the resultant L-C ratio and stored energy will often be such that the loop's Q factor will be so high as to yield an impractically small instantaneous bandwidth that's not useful for SSB communication purposes where a VSWR bandwidth of circa 2 to 3 kHz is the desirable minimum. Achievable bandwidth is roughly proportional to loop size / diameter and Q is inversely proportional to the loop diameter. Depending on its construction a small loop of nominal 1m diameter can exhibit an *intrinsic* radiation efficiency of 90% over the 1.8 to 30 MHz frequency range.

This "intrinsic" efficiency does not take into account the external / extrinsic ground and environmental losses that can suck up power from the localised fields. This quite obvious point can be observed empirically because you can pump in hundreds of Watts of CW power and the loop conductor and tuning capacitor remain cool. If the STL was ostensibly inefficient it would rapidly heat up and melt the silver solder joints with such large levels of input power.

Copper tubing is generally the preferred material to fabricate the loop as it ostensibly has a higher conductivity and lower RF resistance per unit length than aluminium. RF losses are entirely dominated by skin effect and associated bunching concentration of RF current flow along the conductor outer surface. This loss is mitigated through use of large surface area (fat diameter) tubing to form the loop conductor.

Larger size semi-rigid Heliac coax such as LDF550 / LDF650 / LDF750 will conveniently make excellent loop construction material for the smaller diameter 40m to 10m HF band loops when run at the 100 to 1000 Watt power level. The whole of the heliac cable should be used with the inner and outer conductors connected together at their ends.

Copper or aluminium loop conductor material?

This is often a vexed paradoxical question. The subject touches on some old chestnuts of how high-frequency currents flow on conductors and impacting on the important effective RF R_{loss} resistance that's at play when constructing an efficacious STL/MLA.

When a conductor carries a steady state Direct Current, flowing throughout the entire conductor cross-section, the magnetic field is stationary; but with RF current the magnetic field is changing continually. This changing magnetic field which is happening around the loop element is itself inducing back into the conductor, producing its own internal secondary circulating currents; unhelpful eddy currents that have the effect of forcing and bunching the RF current to flow **only** on the outermost surface of the antenna conductor element with an associated skin loss attributed to this eddy current generated so called skin-effect phenomenon. Conductor loss resistance has a square root of frequency law attributed to skin effect.

Skin losses at HF are mitigated by deploying fat tubular shaped conductor elements having large surface area to support the top outer surface confined large RF currents. Smooth surface contours yield minimum conductor loss and RF current flow impediment and highest resultant loop inductor Q factor. The presence of RF loss resistance in the loop conductor manifests as joule heating in the skin depth region where the bunched current flows.

The other way to reduce skin losses is to deploy thin flat strip conductors where the surface area carrying the RF current is a maximum for a minimum of cross-sectional area. Such a cross-sectional geometry tends to reduce the opposing eddy current strength acting upon the large surface area of the conductor carrying the RF current. The thin wide strip conductor geometry reduces the transverse field effect of the resultant eddy currents from disturbing the main RF current using the larger surface area to enable its transport. This scenario is analogous to the technique used in the core of an AC mains transformer where the core is laminated into thin sheets to reduce deleterious eddy current losses. Such geometry beneficially denies eddy currents the means to have much strength in the transverse plane to disturb and impede the main RF current flow in the loop conductor.

Now the skin effect for aluminium is different than in copper due to the fact that the eddy currents set up in aluminium are not as intense as a result of the electron mobility behaviour in the atomic shells, which reflects in the permeability of the material itself. This means that the surface skin depth of an aluminium loop element results in much more of a skin depth than that which exists for copper having the same dimensional parameters. Suffice to say, that the difference in the effective RF resistivity between these two materials in practice is quite small indeed.

This accounts for the seemingly incongruous fact that aluminium which has a DC ohmic resistivity 1.6 times that of copper, but the resistivity to RF is actually not very different. This explains why aluminium small magnetic loops work almost as well as pure copper loop elements...good news for cost conscious loop constructors! In practical terms this means an Al loop element will work on par with Cu loop if the Al element is fabricated with a slightly bigger conductor diameter tube size or width in the case of thin flat strip.

Milli-Ohm meter test instruments are of limited use in transmitting magnetic loop construction assessment work because it's the equivalent entirely skin-effect dominated **RF resistance** of the conductor at the operating frequency that one is interested in...which is only loosely related to the low frequency DC ohmic resistance attributed to the entire cross-sectional area of the conductor. RF current flow of course is confined entirely to the loop tube's outer surface only and profoundly influenced by any conductor imperfections / discontinuities thereon!

Even the surface roughness / granularity and degree of polish influence the conductor's effective loss resistance at RF.

The recommended tough enduring surface protection against the harsh weather elements on the smooth polished copper or aluminium antenna is a clear powder coat thermosetting polymer.

For copper at 10 MHz the skin depth is circa 20 microns, for Al it's a little deeper at 26 um. Conductor thickness beyond several skin depths contributes virtually nothing to supporting the RF current / minimising conductor loss resistance. The guiding rule here for minimising deleterious conductor RF loss resistance in the loop radiating element is big fat OD tube, smooth circular or flat foil large outer surface area Cu contiguous joint-free loop conductors.

The optimum loop form factor shape is a circle as it will yield the best enclosed area to perimeter ratio. Radiation resistance is proportional to loop area, whereas ohmic loss resistance is proportional to the loop circumference / perimeter. A square loop is the worst form factor while an octagonal loop (constructed with tube straights and elbows) encloses beneficially 20% more area than a square of the same circumference and ohmic resistance.

An important point to note is the small loop's radiation resistance and hence radiation effectiveness is proportional to the fourth power of its circumferential length.

The larger bore 2-inch LDF750 can be used on the lower bands to beyond 1 kW. In relation to resistance and conductivity, small loop antennas inherently exhibit very low radiation resistances, which compete with the ohmic resistances of the loop conductor and the resistances from connections and welds, including the tuning capacitor connection. Magnetic loop antennas will typically have a radiation resistance in the order of 100 to 200 milli-Ohms. This means that every additional milli-Ohm caused by a poor contact will cost you one percent efficiency. That is why professional magnetic loop antennas designed for transmitting purposes will never have mechanical contacts and *everything* including the capacitor plates should be welded or silver soldered. It is not uncommon to experience 60 Amperes or more of RF circulating current in the loop and capacitor when fed with several hundred Watts of power.

MLA deployment considerations

In the practical deployment of a loop antenna there are extrinsic factors of both a beneficial and deleterious kind affecting the radiation and loss resistances when the loop is not strictly deployed in an idealised free space scenario.

When the loop is mounted over a perfectly conducting ground plane reflector or copper radial wire mat an electrical image is created that increases the effective loop area. This increase in turn beneficially increases the loop's radiation resistance by a substantial factor. Such a favourable situation is easy to facilitate. Conversely if the loop is placed over average ground (a reasonable reflector) the radiation resistance increases but a reflected loss resistance is also introduced due to transformer effect coupling of reactive near-field energy into the lossy ground. Mounting the loop a certain minimum distance above ground (loop diameter or two) is therefore important as the increase in antenna efficiency gained from minimising intrinsic loop conductor loss can be quickly negated by this deleterious earth proximity resistance (extrinsic factor). Ground loss decreases rapidly as the MLA is raised and becomes insignificant when the antenna is more than about $\lambda/10$ above the ground-air interface boundary.

Similarly when ferrous / iron material is too close, the magnetic near-field of the loop will induce by transformer action a voltage across the RF resistance of the material causing a current flow and associated I^2R power loss.

This situation might for example arise when the loop is mounted on an apartment balcony with nearby iron railing or concrete rebar etc; the deleterious influence can be minimised by simply orienting the loop to sit at right angles to the offending iron or steel material. Additionally there is induced eddy current loss associated with close by conductors and conductive ground falling within the antenna's near-field envelope. Another loss contributing component is due to current flowing in the soil via capacitance between the loop and the soil surface. This capacitive coupling effect is again minimised by keeping the loop at least half a loop diameter or more above the nearby ground. As well as introducing reflected loss to the antenna, varying soil conditions in terms of ionic concentration and moisture variation also profoundly effect the antenna's Q.

Induced ground loss comprises two components; that due to the current induced in a mirror image of the loop below the earth surface with resistance of the image loop being proportional to the soil resistance plus that due to current flowing in the soil via capacitance between the loop and the soil surface. Total systemic loss varies in a complex manner as a function of frequency, loop electrical height above the ground-air interface, electrical characteristics of soil resistance and permittivity, and the RF skin depth of the soil dielectric beneath the MLA.

Interestingly when ground conductivity is high there is a so called ground re-radiation resistance that contributes to radiation from the induced ground currents. This is quite unlike ground reflection. Invariably other conductive objects particularly quasi-resonant ones in the MLA vicinity also contribute to this secondary radiation.

In cases of acutely problematic soils under the loop a sparse PVC copper wire radial mat or metallic screen mesh out to a couple of loop diameters can mitigate the deleterious effect. A portable freestanding transmitting loop is best supported on a short non-metallic mast such as a section of PVC pipe and pedestal foot fashioned from plastic plumbing fittings. The loop can also be placed on a rotator drive plate and turned for best signal strength or it can be oriented in angle to null-out particularly bad QRM.

Failure to pay very careful strict attention to construction details in relation to eliminating all sources of stray losses and making bad siting choices such as close proximity to ferrous and conductive materials are the two main reasons why small magnetic loop antennas sometimes fail to live up to their performance potential; instead behaving as a proverbial "wet noodle" with associated poor signal reports. Conversely a well built / sited loop is an absolute delight.

Sometimes deployment circumstances necessitate operating the MLA indoors or some other kind of non-ideal situation; a scenario with many unknowns in which anything goes. The loop will couple to extraneous objects in the near-field and mid-field vicinity such as electrical wiring, plumbing, furniture, people, fencing, outbuildings, etc, etc. In that scenario one takes pot luck with an unpredictable outcome...sometimes good, sometime bad. Stray currents will be induced in these extraneous objects and cause secondary radiation / re-radiation, as well as reflect back into / perturb and load the loop's resonant impedance, sometimes making it difficult or impossible to achieve a proper match and satisfactory low VSWR.

An MLA should always ideally be deployed "in the clear" with uncluttered and unobstructed surroundings, especially when used for transmitting.

The metric of a good loop antenna is it becomes a sensitive transducer to "sensing" and being impacted by coupling to its proximate environment...somewhat paradoxically that characteristic is actually the desirous hallmark of an efficacious high-Q STL, and conversely a wet noodle MLA will exhibit relative insensitivity to its environment!

MLA safety

Care must be taken not to touch the loop when transmitting and to keep a safe distance away from the loop antenna's strong localized magnetic near-field to ensure conservative compliance with electromagnetic radiation / EMR standards for human exposure to EM fields. A distance equal to or greater than two loop diameters away is generally considered a safe field strength region for Tx powers of 100 Watts and under. RF burns to the skin from touching the loop while transmitting are very unpleasant and such burnt flesh injuries take a long time to heal.



Figure 22 An MLA deployment on elevated condominium balcony

As discussed on Page 21 exceptionally good performance is obtained when deploying an MLA in either horizontal or oblique orientation at great height above ground, i.e. a condominium upper floor balcony or rooftop location.

Miscellaneous practical construction considerations

From preceding discussion, aluminum can be seen to have many practical benefits for MLA construction. Inert gas TIG / heliarc welding is the strongly recommended way to go with aluminum loops and interfacing their associated clamps to vacuum capacitor mounting flanges.

One word of caution when interfacing aluminum to dissimilar metals. Aluminum is highly anodic in its electro-potential and thus very susceptible to deleterious electrolytic corrosion at the point of contact especially in the presence of atmospheric moisture and pollution. Copper, silver, etc are cathodic at the opposite end of the electro-potential series and thus become highly reactive when combined in contact with aluminum. Care should be taken to exclude moisture by some barrier material like vaselene petroleum jelly, neutral cure silicone sealant, or paint over the outer surface of the scrupulously clean and smoothed clamp joint to the vacuum capacitor.

Ideally aluminum loops should be constructed entirely from aluminum and all interfacing joints homogeneously TIG welded as exemplified in Figures 15, 20 and 22. Never rely on aluminum mechanical contacts and clamped joints; they will degrade and become badly ohmic connections and unwanted source of serious resistive loss.

The air variable and vacuum capacitor will require some form of environmental protection from the weather elements and to prevent the build up of dirt and insect ingress. The dielectric and loss tangent properties of this housing material must be thoughtfully chosen as the RF voltage in this region of the loop could be as high as 20 kV or more under QRO excitation power levels.

Comment about loop antenna auto-tune

The perceived need for a slick and salubrious auto-controller for properly tuning an MLA is oftentimes overrated and exaggerated, IMHO.

There is a simple alternative technique that allows you to quickly QSY and tune an STL...there's even a low-cost commercial MFJ box on the market called the MFJ-212 "Matchmaker" that allows you to accurately and safely tune your loop without transmitting a single milliwatt. The circuit goes inline between the rig and antenna and sends a gated broadband noise signal to the antenna using a directional coupler and noise bridge. You just listen on the desired operating frequency and watch your Rx S-meter for a sharp dip whilst adjusting the loop tuning capacitor.

You simply remotely tune the loop with the aid of the receiver S-meter while you are on the wanted frequency without keying up any Tx power output. This makes tuning a breeze without having to move off frequency and have the Tx put out any RF power.

For homebrewers the functionality of the MFJ-212 box can be easily emulated cheaply with just a few dollars worth of common parts [see for example, article in RSGB RadCom magazine by ZL3KB, April 2001, pages 17 to 21].

Such a novel and simple stealth-tune method even makes elaborate microcontroller based servo auto-tune loops redundant and is highly recommended! Now if you use a pan adapter Rx or modern SDR transceiver, it's even simpler as you can see the sharp null on the screen of the Pan Unit band scope display.

The distinguishing merit of the novel gated coupler / noise bridge loop tuning method is its completely passive and covert in operation; you don't transmit any Tx power whatsoever to attain an optimal loop tune setting. The technique makes for fast, QRM free, safe and easy QSY shifts and netting a frequency.

Concluding remarks

The proof of the pudding is always in the eating so experimentally inclined radio amateurs are encouraged to gain some first hand practical experience by getting into the shack workshop and constructing some homebrew loop antennas. Such empirical validation of efficacy is always very gratifying, particularly when a VK station can have a solid 5 and 9 QSO on 40m or 20m with a distant USA or Canadian station from an elegant looking Lilliputian loop sitting on a balcony table fed with a modest 50 Watts! What we ultimately seek from any antenna is reliable HF communication at all times when a band is open for DX propagation and, simply put, that means efficiently radiating most of the RF that's applied to the antenna in a useable bearing direction and take-off angle. The underestimated magnetic loop / compact tuned loop antenna satisfies that basic criteria very well.

HF antenna pattern radiation take-off angle is more important than antenna gain per se, i.e. a good pattern lobbing power in useful directions. Station antenna gain / efficiency is only half the story; it presupposes the power is being launched and directed at a favourable take-off angle for the given highly variable and ephemeral propagation skip path to the distant DX station.

The best achievable high efficiency compact antennas are those with the most uniform current flow and deploying the minimal / shortest circumferential conductor length in any given closed area of space; i.e. a geometric circle comprised of fat copper tubing of the lowest possible self-inductance and loss resistance.

Concertinaing and meander compacting the loop element's end-to-end lineal length does not achieve increased radiation resistance; that valuable highly sought after precious parameter comes from the enclosed physical loop area / volume of space occupied by the structure and its associated spatial fields.

Effectual ham radio communication is ALL about attaining good signal to noise ratio. SNR determines readability during a satisfying QSO, not the brute force received signal strength by itself.

On the 160m and 80m HF low bands even a small and relatively inefficient MLA is better than no antenna at all. An MLA enables highly effective operation on top-band from a small site.

A well designed and constructed small magnetic loop antenna is perhaps one of the rare few instances where a proverbial gallon of performance can be extracted from a little pint bottle!

It is hoped the reader of these notes will gain a good appreciation and working knowledge of magnetic loop antenna characteristics and be better guided in assimilating those factors that really matter and need to be taken into account when contemplating and building an STL antenna project (or two).

© **Leigh Turner VK5KLT**

7 July 2009 / updated 28 November 2010 / updated October 2015