

YAESU

The radio

FT-891

Operating Manual

HF/50MHz TRANSCEIVER

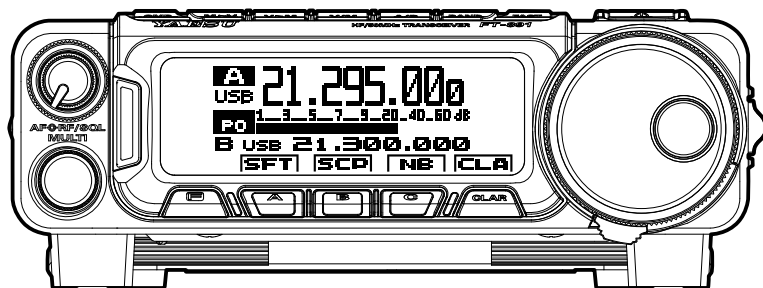

Contents

Introduction	1	Operating Instructions 1	32
Safety Precautions	2	DIAL knob Lock.....	32
Accessories & Options	5	NB (Noise Blanker) (SSB/CW/RTTY/DATA/AM Modes).....	32
Supplied Accessories.....	5	Operating Instructions 2	33
Optional Accessories.....	5	Clarifier (Offsets the receive frequency on the SSB/CW mode).....	33
Installing the Radio	6	Operating Instructions 3	34
Antenna considerations.....	6	IF SHIFT Operation (SSB/CW/RTTY/DATA Modes).....	34
About coaxial Cable.....	6	Operating Instructions 4	35
Connection of Antenna and Power Cables... 6		Meters.....	35
Important precautions for mobile radio operation.....	6	VOX.....	35
Precautions during installation.....	7	Speech Processor.....	35
Install the Antenna.....	7	Parametric Microphone Equalizer.....	35
Install the main body.....	8	Scope	36
Install the Front Panel.....	8	Operation on 60-Meter (5 MHz) Band (U.S. and U.K. Version Only)	37
Installation location when used in a mobile unit.....	8	Memory Operation	38
Connection of Antenna and Power Cables... 9		Normal Memory Storage.....	38
About Antenna.....	9	Naming a Memory Channel.....	38
Before You Begin	10	Memory Groups.....	38
Installing the Microphone.....	10	Memory Channel Recall.....	39
MH-31A8J Microphone Key Buttons.....	11	Moving Memory Data to the VFO-A.....	39
Control Panel Switch & Connectors	12	Erasing Memory Channel Data.....	40
Adjusting the Main tuning DIAL torque.....	12	Restoring Memory Channel Data.....	40
Base Station Tilt Stand	13	Scanning Operation	41
Resetting the Microprocessor	14	VFO Scanning.....	41
All Reset.....	14	Scan Resume Options.....	41
Resetting Memories (only).....	14	Memory Scanning.....	42
Function Resetting.....	15	Scan Resume Options.....	42
Adjusting the display settings	16	Programmable Memory Scan (PMS).....	42
Display Contrast.....	16	CW Mode Operation	43
Display Dimmer.....	16	Transmission (CW mode).....	43
Front Panel Controls & Switches	17	Adjusting the CW delay time.....	43
About the Display	23	Adjusting the Sidetone volume level.....	43
About the Rear Panel	24	Adjusting the Keyer Speed.....	43
Begin Using Your New Transceiver	27	Setting Modes	44
Turning the Transceiver ON and OFF.....	27	Setting Modes Display.....	44
Adjusting the Audio Volume Level.....	27	Using the Setting Modes.....	44
Operating Band and Mode Selection.....	27	Changing the function assigned to the [A]/[B]/[C] keys.....	45
Setting the Operating Frequency.....	28	FUNCTION-1.....	46
Changing frequency up and down quickly with the MULTI function Knob.....	28	FUNCTION-2.....	47
Using the UP/DWN keys of the Supplied MH-31A8J Hand Microphone.....	29	CW SETTING.....	48
Mode Selection.....	29	FM SETTING.....	49
Transmission (SSB/AM/FM mode).....	30	REC SETTING.....	50
QMB (Quick Memory Bank) Channels	31	ATAS SETTING.....	50
QMB Channel Storage.....	31	Menu Mode	51
QMB Channel Recall.....	31	Specifications	56
Erasing QMB Data.....	31		

The FT-891 is a rugged and innovative, multiband, multimode, mobile/portable transceiver for Operation in the amateur radio HF/50 MHz bands. Providing coverage of the 160 - 6 meter bands, the FT-891 includes operation in the SSB, CW, AM and FM modes, yielding the most comprehensive performance package available for mobile and field operation.

Engineered for high performance, the FT-891 transceiver outputs 100 watts of power on the 160 through 6 meter bands.

The display includes bar-graph indications of: power output, ALC voltage, SWR, speech processor compression level, drain current of the final stage FET, and signal strength. Also included are a number of operating status icons, as well as function displays for the three operating function keys (**[A]**, **[B]**, and **[C]**).

Many advanced features that are included in the FT-891, have formerly only been incorporated in large base station transceivers. These include:

- Split-Frequency operation using the Dual VFOs
- Digital Signal Processing (IF SHIFT, IF WIDTH, CONTOUR, IF NOTCH, Noise Reduction, Auto-Notch)
- SSB Clarifier operation to permit offset adjustment of the receive frequency on SSB mode.
- IF Noise Blanker
- AGC Fast/Middle/Slow/Auto selection
- RF Gain and Squelch control
- IPO (Intercept Point Optimization) and a receiver front-end Attenuator
- AM Broadcast reception
- VOX
- Built-in Electronic Keyer with Memories and a Beacon mode
- Adjustable CW Pitch
- Spectrum Scope
- 99 Memories and Band-limiting Memories
- Alpha-Numeric Labeling of Memories
- Automatic Power-Off (APO) and Time-Out Timer (TOT) functions
- Computer Interface capability

We urge you to read this manual and also the Advance Manual (available for download on the Yaesu website) in its entirety, to gain a full understanding of the amazing capability of the exciting new FT-891 Transceiver.

Safety Precautions

Note beforehand that the company shall not be liable for any damages suffered by the customer or third parties in using this product, or for any failures and faults that occur during the use or misuse of this product, unless otherwise provided for under the law.

Type and meaning of the marks



DANGER

This symbol indicates the possibility of death or serious injury being inflicted on the user and the surrounding people when these instructions are ignored and the product is mishandled.



WARNING

This symbol indicates the possibility of death or serious injury being inflicted on the user and the surrounding people when these instructions are ignored and the product is mishandled.



CAUTION

This symbol indicates the possibility of physical impediments occurring or impediments being inflicted on the user and the surrounding people when these instructions are ignored and the product is mishandled.

Type and meaning of symbols



Prohibited actions that must not be attempted, in order to use this radio safely. For example,  signifies that disassembly is prohibited.



Precautions that must be adhered to in order to use this radio safely. For example,  signifies that the power supply is to be disconnected.



DANGER



Do not use the device in “regions or aircrafts and vehicles where its use is prohibited” such as in hospitals and airplanes.
This may exert an impact on electronic and medical devices.



Do not use this product while driving or riding a motorbike. This may result in accidents.
Make sure to stop the car in a safe location first before use if the device is going to be used by the driver.



Do not operate the device when flammable gas is generated.
Doing so may result in fire and explosion.



Do not transmit in crowded places in consideration of people who are fitted with medical devices such as heart pacemakers.
Electromagnetic waves from the device may affect the medical device, resulting in accidents caused by malfunctions.



Never touch the antenna during transmission.
This may result in injury, electric shock and equipment failure.



When an alarm goes off with the external antenna connected, cut off the power supply to this radio immediately and disconnect the external antenna from this radio.
If not, this may result in fire, electric shock and equipment failure.



Do not touch any liquid leaking from the liquid display with your bare hands.
There is a risk of chemical burns occurring when the liquid comes into contact with the skin or gets into the eyes. In this case, seek medical treatment immediately.

WARNING



Do not use voltages other than the specified power supply voltage.
Doing so may result in fire and electric shock.



Do not transmit continuously for long periods of time.
This may cause the temperature of the main body to rise and result in burns and failures due to overheating.



Do not dismantle or modify the device.
This may result in injury, electric shock and equipment failure.



Do not handle the power plug and connector etc. with wet hands. Also do not plug and unplug the power plug with wet hands.
This may result in injury, liquid leak, electric shock and equipment failure.



When smoke or strange odors are emitted from the radio, turn off the power and disconnect the power cord from the socket.
This may result in fire, liquid leak, overheating, damage, ignition and equipment failure. Please contact our company amateur customer support or the retail store where you purchased the device.



Keep the power plug pins and the surrounding areas clean at all times.
This may result in fire, liquid leak, overheating, breakage, ignition etc.



Disconnect the power cord and connection cables before incorporating items sold separately and replacing the fuse.
This may result in fire, electric shock and equipment failure.



Never cut off the fuse holder of the DC power cord.
This may cause short-circuiting and result in ignition and fire.



Do not use fuses other than those specified.
Doing so may result in fire and equipment failure.



Do not allow metallic objects such as wires and water to get inside the product.
This may result in fire, electric shock and equipment failure.



Do not place the device in areas that may get wet easily (e.g. near a humidifier).
This may result in fire, electric shock and equipment failure.



When connecting a DC power cord, pay due care not to mix up the positive and negative polarities.
This may result in fire, electric shock and equipment failure.



Do not use DC power cords other than the one enclosed or specified.
This may result in fire, electric shock and equipment failure.



Do not bend, twist, pull, heat and modify the power cord and connection cables in an unreasonable manner.
This may cut or damage the cables and result in fire, electric shock and equipment failure.



Do not pull the cable when plugging and unplugging the power cord and connection cables.
Please hold the plug or connector when unplugging. If not, this may result in fire, electric shock and equipment failure.



Refrain from using headphones and earphones at a loud volume.
Continuous exposure to loud volumes may result in hearing impairment.



Do not use the device when the power cord and connection cables are damaged, and when the DC power connector cannot be plugged in tightly.
Please contact our company amateur customer support or the retail store where you purchased the device as this may result in fire, electric shock and equipment failure.



Follow the instructions given when installing items sold separately and replacing the fuse.
This may result in fire, electric shock and equipment failure.



Do not use the device when the alarm goes off.
For safety reasons, please pull the power plug of the DC power equipment connected to the product out of the AC socket. Never touch the antenna as well. This may result in fire, electric shock and equipment failure due to thunder.

Safety Precautions



CAUTION



Do not place this device near a heating instrument or in a location exposed to direct sunlight.

This may result in deformation and discoloration.



Do not place this device in a location where there is a lot of dust and humidity.

Doing so may result in fire and equipment failure.



Stay as far away from the antenna as possible during transmission.

Long-term exposure to electromagnetic radiation may have a negative effect on the human body.



Do not wipe the case using thinner and benzene etc.

Please use a soft and dry piece of cloth to wipe away the stains on the case.



Keep out of the reach of small children.

If not, this may result in injuries to children.



Do not put heavy objects on top of the power cord and connection cables.

This may damage the power cord and connection cables, resulting in fire and electric shock.



Do not transmit near the television and radio.

This may result in electromagnetic interference.



Do not use optional products other than those specified by our company.

If not, this may result in equipment failure.



When using the device in a hybrid car or fuel-saving car, make sure to check with the car manufacturer before using.

The device may not be able to receive transmissions normally due to the influence of noises from the electrical devices (inverters etc.) fitted in the car.



For safety reasons, switch off the power and pull out the DC power cord connected to the DC power connector when the device is not going to be used for a long period of time.

If not, this may result in fire and overheating.



Do not throw or subject the device to strong impact forces.

This may result in equipment failure.



Do not put this device near magnetic cards and video tapes.

The data in the cash card and video tape etc. may be erased.



Do not turn on the volume too high when using a headphone or earphone.

This may result in hearing impairment.



Do not place the device on an unsteady or sloping surface, or in a location where there is a lot of vibration.

The device may fall over or drop, resulting in fire, injury and equipment failure.



Do not stand on top of the product, and do not place heavy objects on top or insert objects inside it.

If not, this may result in equipment failure.



Do not use a microphone other than those specified when connecting a microphone to the device.

If not, this may result in equipment failure.



Do not touch the heat radiating parts.

When used for a long period of time, the temperature of the heat radiating parts will get higher, resulting in burns when touched.



Do not open the case of the product except when replacing the fuse and when installing items sold separately.

This may result in injury, electric shock and equipment failure.

Supplied Accessories

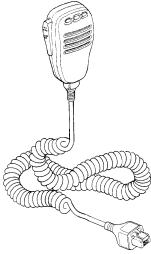

Microphone
MH-31A8J

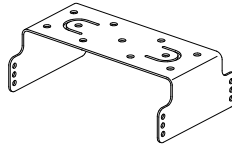

Mobile Mounting Bracket
MMB-82
(Attachment screw set)

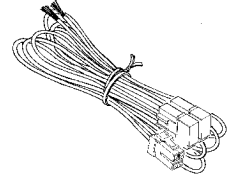

DC power cable w/Fuse

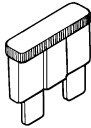

Spare fuse (25 A)

Operating Manual

Quick Manual

Warranty Card

Optional Accessories

MH-31A8J	Microphone
MH-36E8J	DTMF Microphone
M-1	Reference Microphone
MD-200A8X	Ultra-High-Fidelity Desktop Microphone
MD-100A8X	Desktop Microphone
MLS-100	High-Power External Speaker
YH-77STA	Lightweight Stereo Headphone
VL-1000/VP-1000	Linear Amplifier / AC Power Supply
FC-40	External Automatic Antenna Tuner
FC-50	External Automatic Antenna Tuner
ATAS-120A	Active Tuning Antenna (Automatic Type)
ATAS-25	Active Tuning Antenna (Manual Type)
ATBK-100	Antenna Base Kit
FH-2	Remote Control Keypad
YSK-891	Separation Kit
MMB-82	Mobile Mounting Bracket
SCU-17	USB Interface Unit
CT-58	VL-1000 Linear Amplifier Connection Cable
CT-39A	Packet Interface Cable
FP-1030A	AC Power Supply (25 A) (USA and Asian market only)

Installing the Radio

Antenna considerations

The FT-891 is designed for 50 Ohm resistive impedance at the amateur operating frequencies. Select the proper antenna (dipole antenna, YAGI antenna, cubical quad antenna, etc.) suitable for the chosen operation and bands.

Construct the antenna and coaxial cable, or use a suitable antenna tuner, to maintain the impedance presented to the FT-891 antenna connector for an SWR of 1.5 or less. Careful preparation of the antenna and/or tuner will permit maximum performance and protect the transceiver from damage. High voltages may be present on the antenna; install it so it will not be easily touched when in operation.

- Create a loop (slack) in the co-axial cable directly underneath the antenna and fasten it so that the weight of the cable does not pull on the antenna or connector itself.
- Install the antenna taking into consideration the securing supports and how the guying wires are positioned, so that the antenna does not fall over or get blown away in strong winds.

About coaxial Cable

Use high-quality 50-Ohm coaxial cable for the lead-in to your FT-891 transceiver.

Connection of Antenna and Power Cables

Please follow the outline in the illustration regarding the proper connection of antenna coaxial cables.

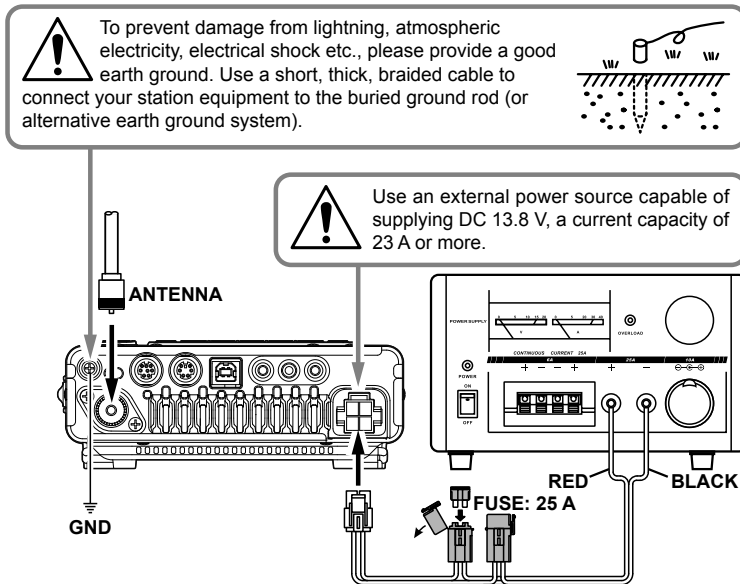

Important precautions for mobile radio operation

- The use of protective tape or covering is recommended to protect the wiring and the power cord inside the vehicle.
- When installing the unit inside a vehicle, locate the radio, antenna, co-axial cable, etc. at least 20 cm (8 inches) away from the following control equipment:
 - Engine-related: Fuel injection equipment and engine control
 - Transmission-related: Transmission and 4WD electronic control unit
 - Others: ECS/EPS/ABS/ETACS/Fully automatic air-conditioner/Auto-heater control unit/G sensor

Installing the Radio

- Install the antenna and co-axial cable away from the control unit and wiring harness. Place all cables so they do not entangle and impede the driver or passengers. Never place any equipment in a location where it may pose a danger to the passengers, where it may interfere with driving, or obstruct the driver field of view.
- Do not install any apparatus in such a way that it may interfere with the proper operation of the air bags.
- After installing the radio, check that the brake lamp, head lamp, turning indicator lights, wiper, etc. are working normally with the radio power switched on.
- Keep full attention on driving, do not operate the radio controls or look at the radio display while driving. Stop the vehicle at a safe location, before operating the radio controls or looking at the display.
- Do not drive the car in such a way that external sounds required for safe driving cannot be heard. Most areas and districts prohibit the use of earphones and headphones while driving.
- If operation of the radio transmitter appears to have abnormal effects on the control equipment of the vehicle, stop the engine, turn off the transceiver power supply, and disconnect the power cord. Resolve the problem before continuing to operate the radio equipment.
- When using the radio in an electric or hybrid car, the receiver may experience high RF interference and noise from the inverters that are built into the electric vehicle.

Precautions during installation

Note the following when installing this radio.

- Do not install the radio in a place where there is extreme vibration, where there is a lot of dust, excessive humidity or high temperature, or where it is exposed to direct sunlight.
- Install the radio in a well ventilated position, so heat release is not obstructed because the heat sink gets hot when transmitting repeatedly.

Install the Antenna

- Ensure that the antenna base is securely fixed.
- Ensure that the antenna base is securely grounded to the car body.
- Avoid routing the co-axial cable enclosed with a commercial car antenna cable.
- Do not place the co-axial cable or connectors inside the car where rain water or moisture may penetrate them.

Installing the Radio

Install the main body

Install the main body using the provided MMB-82 bracket.

- Do not install the FT-891 in a place with intense vibration.
- Attach the bracket firmly with the supplied screws, so it will not become loose.

1. Holes in the location where the bracket is to be mounted

Drill four 6 mm diameter holes in the location where the bracket is to be mounted matching the positions of the bolting holes of the bracket.

2. Attach the bracket

Using the provided bolts, nuts and washers.

3. Fasten the transceiver to the bracket

Using the provided flange bolts, as shown in the drawing.

- The mounting angle can be changed depending on the securing position of the flange bolts.

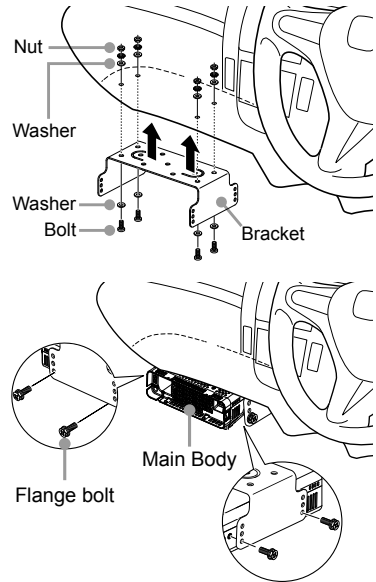

Install the Front Panel

Install the front panel using the optional bracket.

- The bracket can be bent by hand to match the location where the controller is going to be installed. Take due care not to injure yourself when bending the bracket.
- Select a stable, flat location with as few dents and protrusions as possible.

Installation location when used in a mobile unit

Front Panel

It is recommended that the front panel be installed on top of the car dash board.

Main body

It is recommended that the main body be installed below the car dash board.

- Do not install the front panel, the transceiver or the wire cables near the air bags. In case of emergency, the transceiver may interfere with air bag deployment and result in accidents and injury. The wire cables may also cause the air bag to malfunction.

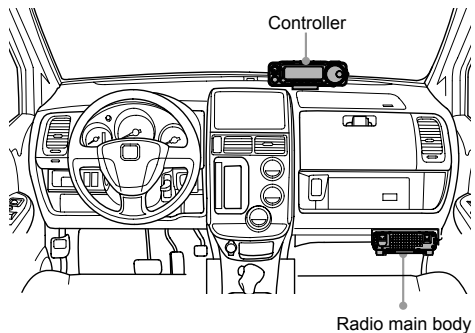

Connection of Antenna and Power Cables

Please follow the outline in the illustration regarding the proper connection of antenna coaxial cables, as well as the DC power cable.

High current is carried during transmissions. The DC power supply cable must connect directly to the negative ground, 12 V car battery.

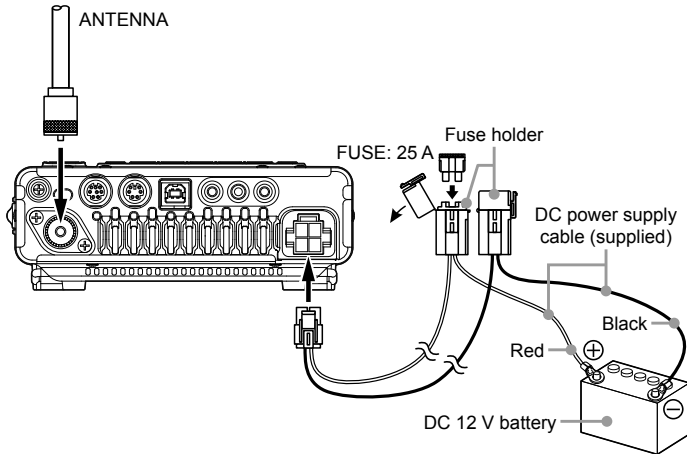

- Use the transceiver only in a car with a negative ground 12 V DC system, where the minus (-) pole of the battery is connected to the car body.
- Do not connect the radio to the 24 V battery of a large vehicle.
- Do not use a DC power cable other than the one that is supplied or specified.
- High current is carried during transmissions; do not use the cigarette lighter connector inside the car as a power source.



High RF voltage is present in the TX RF section of the transceiver while transmitting. Absolutely! Do not touch the TX RF section while transmitting.



Permanent damage can result when improper supply voltage, or reverse polarity voltage, is applied to the FT-891. The Limited Warranty on this transceiver does not cover damage caused by application of AC voltage, reverse polarity DC, or DC voltage outside the specified range of 13.8 V \pm 15 %. When replacing fuses, be certain to use a fuse of the proper rating. The FT-891 requires a 25 Amp blade fuse.

About Antenna

The FT-891 is designed for 50 Ohm resistive impedance at the amateur operating frequencies.

Select the proper antenna, suitable for the chosen operation and bands. Maintain the impedance presented to the FT-891 antenna connector for an SWR of 1.5 or less.

Careful preparation of the antenna and/or tuner will permit maximum performance and protect the transceiver from damage.

High voltages may be present on the antenna; install it so it will not be easily touched when in operation.

Before You Begin

Installing the Microphone

1. To separate the Front Panel, use your thumb to push the latch on the right-hand side of the panel slightly rearward, and then slide the Front Panel to the left and away from the transceiver.

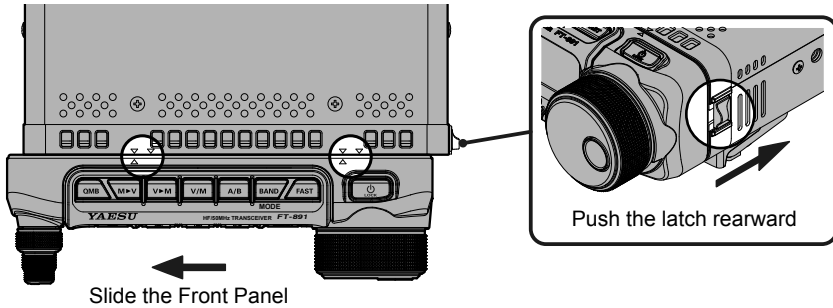

2. Insert the microphone plug into the recessed jack on the transceiver, as shown in the illustration.

NOTE: When disconnecting the microphone, pull the cable while pressing the connector latch.

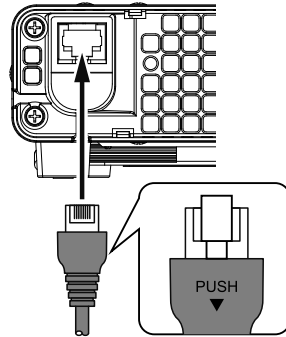

3. The microphone cable may be positioned so that it will exit from the side or the bottom of the transceiver. Just route the cable into the appropriate channel provided, as shown in the illustration.

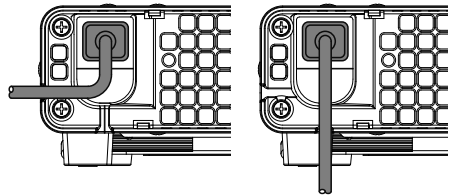

4. Install the Front Panel by sliding it into the position shown; you will hear a "click" when the panel locks into place.

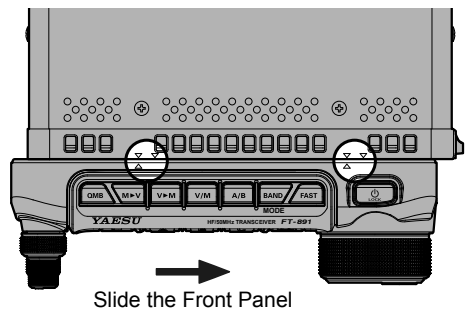

MH-31A8J Microphone Key Buttons

① PTT Switch

Switches transmit/receive.
Press to transmit and release to receive.

② DWN key

Press the **DWN** (Down) key to scan the frequency downward.

③ FST key

Changes the frequency step, this key works in the same way as the [FAST] key on the transceiver top panel.

④ UP key

Press the **UP** key to scan the frequency upward.

⑤ Microphone

Speak into the microphone in a normal tone of voice with the microphone 5 cm away from your mouth.

⑥ TONE Switch

Alters transmit sound quality. Slide the switch to the “1” position for a “flat transmit audio response, Slide the switch to the “2” position to emphasize transmit audio.

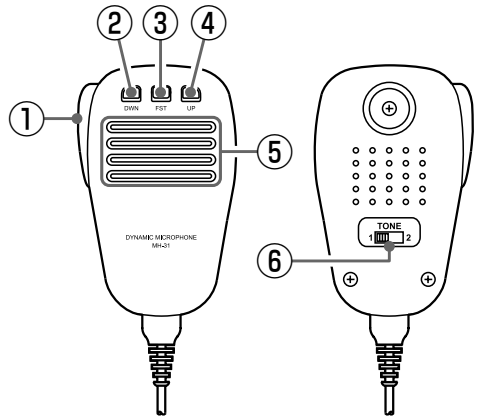

Control Panel Switch & Connectors

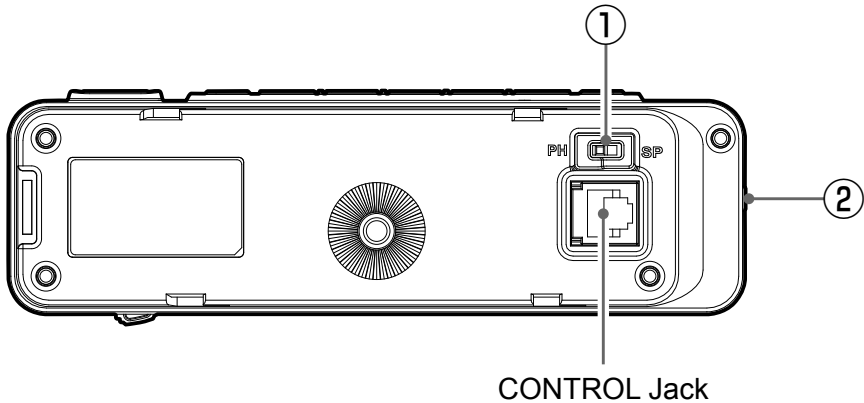

① SP-PH switch

If you use earphones with this transceiver, move this switch to the “PH” position before inserting the earphone plug into the SP/PH Jack, to prevent injury your ears.

② SP/PH jack

This 3.5-mm, 2-pin jack provides adjustable audio output for an external speaker ($4\ \Omega \sim 16\ \Omega$ impedance) or earphones. The audio level varies according to the setting of the front panel AF knob.

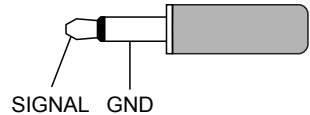

Important Note: When an earphone plug is inserted into this jack, the SP-PH slide switch (located on the back side of the front panel) **MUST BE** set to the “PH” position, to prevent the possibility of injury to your ears.

Adjusting the Main tuning DIAL torque

The torque (drag) of the Main Tuning **DIAL** knob may be adjusted for your operating preferences. Slide the lever clockwise to reduce the drag, or counter-clockwise to increase the drag.

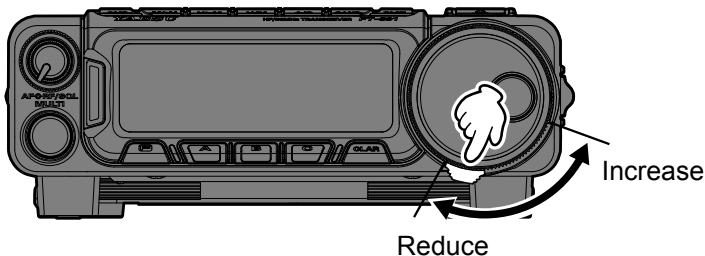

Base Station Tilt Stand

The sturdy stand on the bottom of the transceiver allows the transceiver to be tilted upward for better viewing. Simply fold the stand forward to raise the front of the transceiver, and fold it back against the bottom case to lower the front of the FT-891.

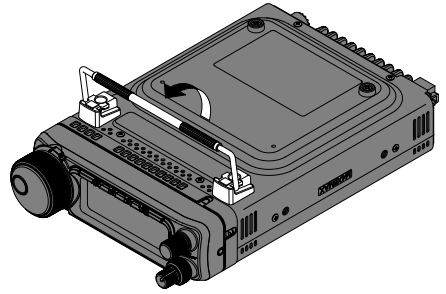
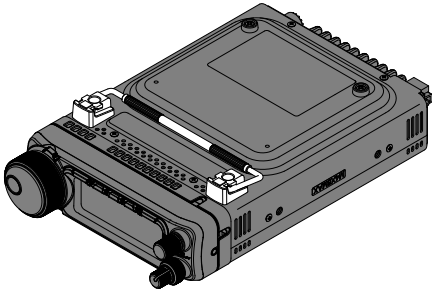

Resetting the Microprocessor

All Reset

Use this procedure to restore all settings to their original factory defaults. All Memories will be cleared by this procedure.

1. Press and hold in the **(11) [F]** key for one second to activate the Menu mode.
2. Rotate the **(17) MULTI** function knob to select Menu Mode “**17-01 [RESET]**”.
3. Press the **(17) MULTI** function knob, and then rotate the **(17) MULTI** function knob to select “**ALL**”.
4. Press and hold the **(17) MULTI** function knob to reset and automatically restart the transceiver.

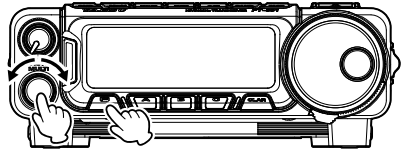

Resetting Memories (only)

Use this procedure to reset (clear) the previously stored Memory channels, without affecting any configuration changes you may have made to the Menu settings.

NOTE: The FT-891 cannot erase the memory channels “01” (and “501” through “510”: U.S. version).

1. Press and hold in the **(11) [F]** key for one second to activate the Menu mode.
2. Rotate the **(17) MULTI** function knob to select Menu Mode “**17-01 [RESET]**”.
3. Press the **(17) MULTI** function knob, and then rotate the **(17) MULTI** function knob to select “**DATA**”.
4. Press and hold the **(17) MULTI** function knob to reset and automatically restart the transceiver.

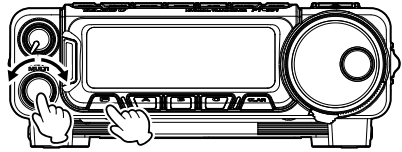

Resetting the Microprocessor

Function Resetting

Use this procedure to restore Menu and Programmable Multi Function ⑫ [A]/[B]/[C] key settings to their factory defaults, without affecting the programmed memories.

1. Press and hold in the ⑪ [F] key for one second to activate the Menu mode.
2. Rotate the ⑰ **MULTI** function knob to select Menu Mode “17-01 [RESET]”.
3. Press the ⑰ **MULTI** function knob, and then rotate the ⑰ **MULTI** function knob to select “FUNC”.
4. Press and hold the ⑰ **MULTI** function knob to reset and automatically restart the transceiver.

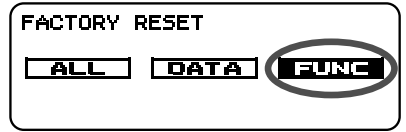
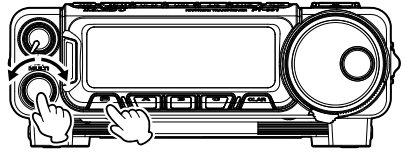

Adjusting the display settings

Display Contrast

The LCD contrast may be adjusted using the Menu Mode.

1. Press and hold in the **(11) [F]** key for one second to activate the Menu mode.
2. Rotate the **(17) MULTI** function knob to select Menu Mode “**02-01 [LCD CONTRAST]**”.
3. Press the **(17) MULTI** function knob, and then rotate it to adjust the contrast. The contrast change may be observed as the knob is adjusted.

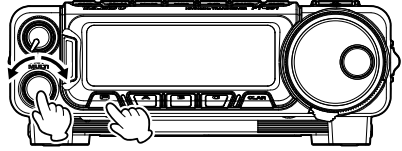

MENU	02-01	DISPLAY
LCD CONTRAST	8	
DIMMER BACKLIT	8	
DIMMER LCD	8	
DIMMER TX/BUSY	8	

4. When the adjustment is satisfactory, press the **(17) MULTI** function knob.
5. Press the **(11) [F]** key to save the new setting and exit the Menu mode to normal operation.

Display Dimmer

The LCD illumination level may also be adjusted using the Menu Mode.

1. Press and hold in the **(11) [F]** key for one second to activate the Menu mode.
2. Rotate the **(17) MULTI** function knob to select Menu Mode “**02-03 [DIMMER LCD]**”.
3. Press the **(17) MULTI** function knob, and then rotate it to adjust the display illumination for a comfortable brightness level. The change may be observed as the knob is adjusted.

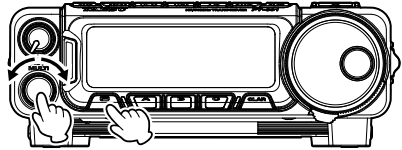

MENU	02-03	DISPLAY
DIMMER LCD	8	
DIMMER TX/BUSY	8	
PEAK HOLD	OFF	
ZIN LED		DISABLE

4. When the adjustment is completed, press the **(17) MULTI** function knob.
5. Press the **(11) [F]** key to save the new setting and exit the Menu mode to normal operation.

Front Panel Controls & Switches

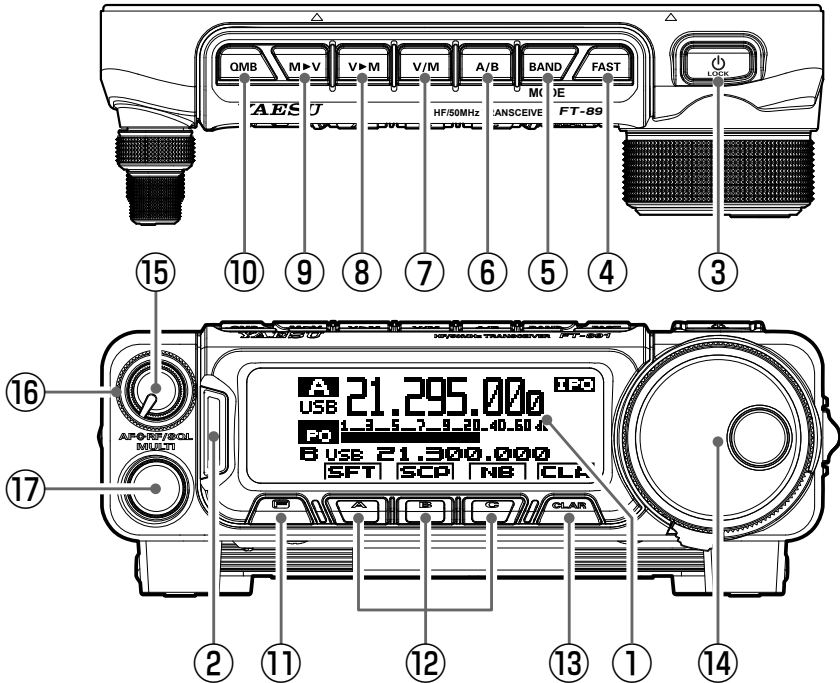

① LCD Display

The LCD (Liquid Crystal Display) shows the operating frequency and indicates of the status of other transceiver functions.

② TX/BUSY Indicator

The Indicator glows green: While the squelch opens on receiving signals.

The Indicator glows blue: While Zeroing during CW mode.

On receiving a signal with a CTCSS/DCS tone matching the squelch tone code setting of the transceiver.

The Indicator glows red: When transmit is engaged.

③ [PWR/LOCK] key

Press and hold this key to turn the transceiver ON or OFF.

Briefly press the key while the transceiver is ON to engage the ⑭ MAIN DIAL knob lock.

This key toggles the ⑭ MAIN DIAL knob lock ON/OFF.

④ [FAST] key

Press this key to change the tuning of the ⑭ MAIN DIAL to a higher step rate.

The "FAST" will be displayed at the bottom right corner of the screen.

The tuning steps for the ⑭ MAIN DIAL knob are set at the factory to 10 Hz -100 Hz for one step and 20 kHz for each dial rotation, in the SSB/AM/CW/RTTY/DATA Mode (One kHz for each step and 200 kHz for each dial rotation in the FM Mode).

Front Panel Controls & Switches

⑤ [BAND (MODE)] key

- Press this key to display the “BAND SELECT” screen (Operating band selection screen).

Rotate the ⑭ **MAIN DIAL** knob to select the desired frequency band (operating band).

The selected frequency band will be set automatically in one second and the display will return to normal operation.

- Press and hold this key to display the “MODE SELECT” screen.

Rotate the ⑭ **MAIN DIAL** knob to select the radio modulation form (operating mode).

The selected operating mode will be set automatically in one second and the display will return to normal operation in the selected operating mode. (The mode is automatically preset for each operating band, it is only necessary to set “MODE SELECT” when a change is desired).

⑥ [A/B] key

Pressing this key momentarily, exchanges the frequency and memory channel data of VFO-A and VFO-B.

Press and hold this key for one second to set VFO-A and VFO-B to the same frequency and data values.

⑦ [V/M] key

This key toggles frequency control between the VFO and the memory systems.

- When the memory channel data is recalled, the previously selected Memory channel number is displayed like “**MC1**”.

- Rotate the ⑰ **MULTI** function knob to change the memory channel number.

- While operating on a memory channel, if the ⑭ **MAIN DIAL** knob is turned, the “Memory Channel Number” will be replaced by the MEMORY TUNE indicator “**MT**”; this indicates that the operating frequency of the Memory Channel is temporarily changed. Pressing the [V/M] key while in the MEMORY TUNE state will restore the previous memory channel data.

⑧ [V►M] key

This key is used to save the data from VFO-A to a memory channel.

Press this key to display the “MEMORY CHANNEL” list screen.

Rotate the ⑰ **MULTI** function knob to select the desired memory channel.

Press this key again to copy the VFO-A operating data to the selected memory channel.

- When the “MEMORY CHANNEL” list screen is displayed, press the ⑫ [A]/[B]/[C] key to edit the selected memory channel.

⑨ [M►V] key

This key will copy the saved data from a written memory channel to VFO-A.

Press this key to display the “MEMORY CHANNEL” list screen.

Rotate the ⑰ **MULTI** function knob to select the desired previously written memory

channel.

Press this key again to copy the currently selected memory channel data to VFO-A.

⑩ [QMB] key

Press and hold this key for more than one second to write the frequency and the data presently displayed on VFO-A to the quick memory bank (QMB).

- Once all 5 QMB memories have data written on them, the previous data will be over-written on a first-in, first-out basis.
- 5 QMB memory channels are provided. Press this key briefly to recall the data written onto the quick memory banks (QMB) one by one.
- To change the frequency in the recalled quick memory bank (QMB), rotate the ⑭ **MAIN DIAL**.

NOTE: For details on the Quick Memory Bank function, see page 31.

⑪ [F] key

Repeatedly press this key momentarily to step through the Setting Modes as follows:

▣ FUNCTION-1 ▣ FUNCTION-2 ▣ CW SETTING ▣

- Select the desired function from the **Setting Modes**, and then press the ⑰ **MULTI** function knob to switch the selected function ON or OFF.
- While in the **Setting Modes**, to assign the **Setting Modes** to the ⑫ [A]/[B]/[C] keys, rotate the ⑰ **MULTI** function knob to select the desired function, and then press and hold the ⑫ [A]/[B]/[C] key.
- **FM SETTING**, **REC SETTING** and **ATAS SETTING** function screens may be enabled via Menu mode “05-10”, “05-11” or “05-12”.
- To return to normal operation, rotate the ⑭ **MAIN DIAL** or press another key.

Press and hold this key to activate the Menu mode.

⑫ Programmable Multi Function [A]/[B]/[C] keys

These three keys are user programmable, allowing quick access to often used functions.

- [A]/[B]/[C] keys are assigned the following functions as default settings:

• [A] (SFT): IF SHIFT function

In the SSB mode, IF SHIFT permits moving the DSP filter passband higher or lower, without changing the pitch of the incoming signal, and thus reduces or eliminates interference.

1. Press this key to display the IF SHIFT screen.
2. Rotate the ⑰ **MULTI** function knob to the left or right to reduce interfering signals.
3. Press and hold the ⑰ **MULTI** function knob to restore the IF SHIFT setting to the factory default.

Front Panel Controls & Switches

● [B] (SCP): The SCOPE function

The SCOPE function provides a spectrum display of the band conditions.

Press this key to display the band condition (spectrum).

When the SCOPE function is active, the [A]/[B]/[C] keys are automatically changed to the below operations.

[A](SPN) key: This key changes the displayed bandwidth. Available selections are 750 kHz, 375 kHz, 150 kHz, 75 kHz, or 37.5 kHz ranges.

[B](SWP) key: Each time the [B](SWP) key is pressed, a new scan of the spectrum scope is shown on the LCD display.

The SWP icon blinking on the LCD is confirmation that the “Continuous Sweeping mode” is running.

- Since the FT-891 has only one receiver the audio will be muted while the spectrum scope is scanning. To stop scanning and turn the receiver on, set the desired frequency and press the [B](SWP) key again.

[C](LV1-3) key: This key changes the gain.

- While the Spectrum Scope is activated, Press the ⑰ **MULTI** function knob, and then rotate it to adjust the operating frequency tuning steps of VFO-A by the 500 kHz.

● [C] (NB): Noise Blanker function

The IF Noise Blanker can significantly reduce the noise that is caused by automotive ignition systems.

⑬ [CLAR] key

During reception, press this key, and then rotate the ⑰ **MULTI** function knob to adjust the VFO-A RX clarifier offset value up to ± 9.998 kHz.

- The clarifier offset value (frequency) can be restored to “0 (zero)” by pressing the ⑰ **MULTI** function knob for more than one second.

NOTE: For details on the clarifier function, see “Clarifier (Offsets the receive frequency on the SSB/CW mode)” on page 33.

⑭ **MAIN DIAL**

This is the main tuning dial for the transceiver. Rotate this knob clockwise to increase the operating frequency and rotate it counterclockwise to decrease the operating frequency.

- Pressing the ④ [FAST] key will change the tuning of the **MAIN DIAL** to a higher step rate. The frequency steps available are 10Hz and 100Hz per step (2kHz and 20kHz per rotation).
- Pressing the ③ [PWR/LOCK] key briefly will engage or release the DIAL knob lock.

⑮ **AF Knob**

The (inner) AF knob adjusts the receiver audio volume level of the internal or external speaker. Clockwise rotation increases the volume level.

⑩ RF/SQL knob

Rotate this knob counter-clockwise to reduce the background noise and the system gain. Rotate this knob fully clockwise to set the gain to the highest level for normal operations. Counter-clockwise rotation will raise the start position of the S-Meter indication. When receiving a strong signal, the noise is reduced and the signal is emphasized.

- Rotate this knob slightly counter-clockwise to the point where the “stationary” meter indication is set just about the same as the receiver noise level.
- This control may be changed to function as the squelch control by selecting “SQL” on Menu Mode “05-05 [RF/SQL VR]”.

NOTE: For additional details, refer to the Advanced Manual which may be downloaded from the Yaesu website.

⑪ MULTI function knob

This knob incorporates multiple tasks and makes it very convenient to operate the various functions of the FT-891.

1 Adjusts the operating frequency of VFO-A in 500 kHz Steps (except the for AM and FM modes)

By pressing the **MULTI** function Knob momentarily until the “**A**” is displayed, the operating frequency steps of VFO-A may be adjusted in 500 kHz steps.

By rotating the **DIAL** knob while “**A**” is displayed, the 500 kHz step adjustment of the **MULTI** function knob is canceled (the “**A**” indication will be returned to “**A**”).

If you want to adjust the operating frequency steps of VFO-A by the 500 kHz again, make sure that the “**A**” is displayed on the screen.

- The operating frequency 500 kHz steps of VFO-A can be changed via Menu mode 14-01“[QUICK DIAL]”

2 Adjusts the operating frequency of VFO-B

By pressing **MULTI** function Knob momentarily until the “**B**” is displayed, the operating frequency of VFO-B may be adjusted. This function is convenient for changing the transmit frequency on split operation.

3 Operates the ⑫ [A]/[B]/[C]/ ⑬ [CLAR] key function

When the ⑫ [A] key is assigned to the IF SHIFT function:

Pressing the ⑫ [A] key will display the IF SHIFT pop-up screen, and then rotation of the **MULTI** function Knob will adjust the DSP filter passband.

- An indication mark is displayed to the left of the function key status icon.
- Press and hold the **MULTI** function Knob to restore the IF SHIFT setting to factory defaults.
- When another function assigned to an ⑫ [A]/[B]/[C] key has no setting that can be adjusted by the **MULTI** function Knob, the **MULTI** function Knob is not active.

4 Selects the Desired memory channel

When the “MEMORY CHANNEL” list screen is displayed, the desired memory channel can be selected by rotating and pressing **MULTI** function Knob.

Front Panel Controls & Switches

5 Switches the Setting Modes ON/OFF

Operates the Setting Modes that are displayed by pressing the ⑪ [F] key:

- Select menu functions (Rotate the **MULTI** function Knob)
- Switch the function ON or OFF (Press the **MULTI** function Knob)
- Change the setting values (Press the **MULTI** function Knob, to turn the functions ON and then rotate it)
- Reset the setting values to the factory default value (Rotate the **MULTI** function Knob to select the function, and then press and hold the **MULTI** function Knob)

6 Changes the Menu Mode setting values

Refer to the “Menu Mode” on page 51.

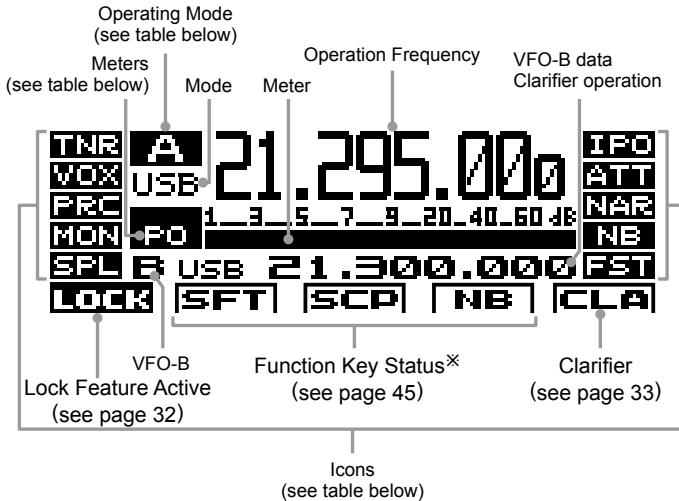

※ Display examples of the Function key (in the case of Noise Blanker)

[NB]: Function “OFF”.

[NB]: Function “ON”.

[NB]: Function “ON” and then turn the ⑰ **MULTI** function knob to change the assigned feature setting.

Operating Mode Indicators	
A / A	VFO-A
MC1 / MC1	Memory Channel Number
PMS / PMS	Programmable Memory Scanning
QMB / QMB	Operating with the Quick Memory Bank
MT / MT	Memory tune
EMG / EMG	Recalling the emergency contact frequency

Meters	
PO	Displays transmitter output power
ALC	Displays ALC voltage
SWR	Displays Standing Wave Ratio
CMP	Displays the speech processor compression level
IDD	Displays the drain current of the final stage FET transistors

※ The Indication of each meter is not precise but is a relative value and a rough indication.

Icons			
TNR	Antenna Tuner	SPL	Running split operation
ATS	Active Tuning Antenna System	IFO	The receiver preamplifier is OFF
LAF	Connecting the linear amplifier	ATT	The attenuator is in use
VOX	The VOX function is in use	NAR	The Narrow IF DSP filter is in use
PRC	The Speech Processor function is in use	NB	The noise blanker is in use
MON	The Monitor function is in use	FST	MAIN DIAL at a higher step rate.

About the Rear Panel

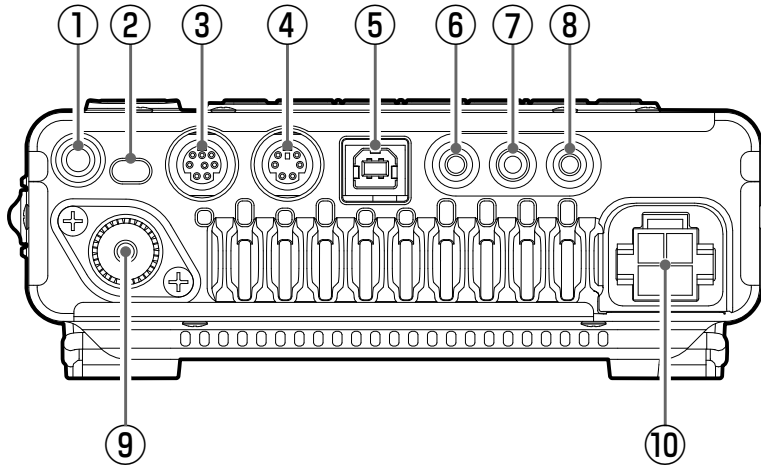

① GND

Use this terminal to connect the transceiver to a good earth ground, for safety and optimum performance.

Use a large diameter, short braided cable to make the ground connections.

② Firmware update switch

Use this switch when updating the firmware. When a new firmware update for the FT-891 is available, go to the YAESU website to download the programming data and update the FT-891 to its newest state.

To update the firmware, connect the USB Jack ⑤ to a computer.

③ TUN/LIN

Connect the optional external antenna tuner “FC-50”, “FC-40” or the linear amplifier “VL-1000”.

Connect a Linear Amplifier “VL-1000” with an optional “CT-58” Linear Amplifier Connection Cable.

Connect an External Automatic Antenna Tuner FC-40,FC-50 with the control cable supplied with the tuner.

NOTE: For details, refer to the Advanced Manual (download from the Yaesu website).

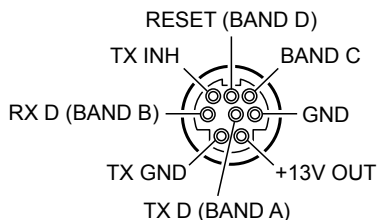

④ RTTY/DATA

This is the input/output jack to connect a terminal unit for RTTY and TNC for packet communications.

Connect a terminal unit with the optional “CT-39A” Packet Interface Cable.

NOTE: For details, refer to the Advanced Manual (download from the Yaesu website).

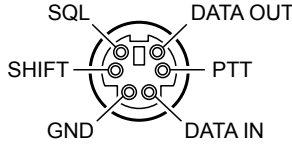

⑤ USB Jack

Control the transceiver remotely from a computer using the CAT commands.

Transmission control, can also be done from the computer.

Connect the computer with a commercially available USB cable.

NOTE: To control the transceiver remotely from the computer, a USB driver is required.

For details on the USB driver, visit the Yaesu website.

⑥ REM/ALC

Connect the optional remote control keypad “FH-2”.

When a device such as a linear amplifier is connected, this is an external ALC current input jack.

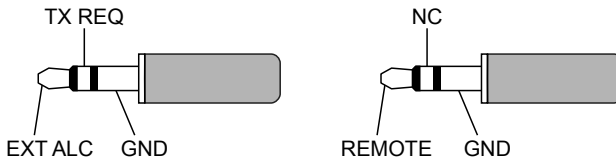

⑦ KEY Jack

Connect a telegraph key or electronic keyer paddle to use for CW mode operation.

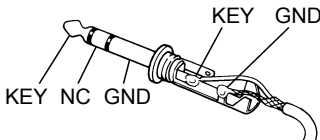

When connecting a single straight key

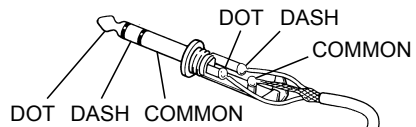

When connecting an electronic keyer paddle

This 3.5 mm, 3-contact jack accepts a CW key or keyer paddles (for the built-in electronic keyer), or the output from an external electronic keyer. Contact connections are shown below. Keyup is 5 volts, and key down current is 1 mA. Use only the 3.5 mm 3 contact type plug. An incorrect size plug may damage the jack. If the Keyer plug is inserted into and removed from the jack while the FT-891 is in operation, the FT-891 may be switched to the transmit mode.

About the Rear Panel

Always turn off the power of the FT-891 before connecting or disconnecting the Keyer.

⑧ EXT SPKR

This is the monaural jack to connect an external speaker (4 Ω to 8 Ω).

Connecting an external speaker to this jack will deactivate the internal speaker.

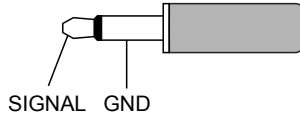

⑨ ANT Jack

This is the M-type coaxial connector to connect HF band and 50 MHz band antennas (50 ohms).

⑩ DC IN Jack

This is the DC power supply connection for the transceiver. Use the supplied DC cable to connect directly to a DC power supply, which must be capable of supplying at least 23 A @13.8 VDC.

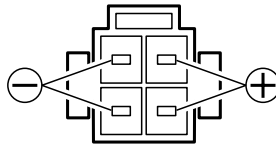

Turning the Transceiver ON and OFF

1. To turn the transceiver ON, press and hold the ③ [PWR/LOCK] key for one second.
2. To turn the transceiver OFF, again press and hold the ③ [PWR/LOCK] key for one second.

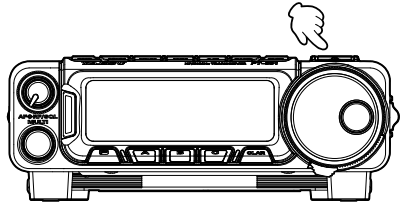

Adjusting the Audio Volume Level

Rotate the ⑮ AF knob to set a comfortable listening level.

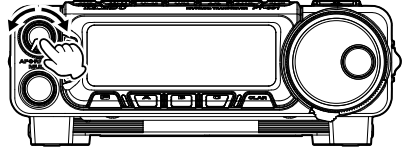

Operating Band and Mode Selection

Follow the below instructions to easily select the Amateur Bands and preset modes. Frequencies outside the Amateur Bands may only be received(No Transmit).

1. Press the ⑤ [BAND(MODE)] key.
The "BAND SELECT" screen will appear in the display.
2. Rotate the **DIAL** knob to select the desired operating band.

The selections available are:

... ⇄ 1.8 MHz ⇄ 3.5 MHz ⇄
⇄ 7.0 MHz ⇄ 10 MHz ⇄ 14 MHz ⇄
⇄ 18 MHz ⇄ 21 MHz ⇄ 24 MHz ⇄
⇄ 28 MHz ⇄ 50 MHz ⇄...

NOTE: When the desired operating Band is selected, the display will automatically return to normal operation after 0.5 second.

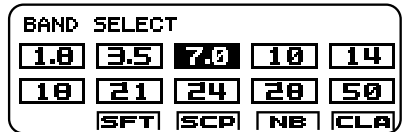
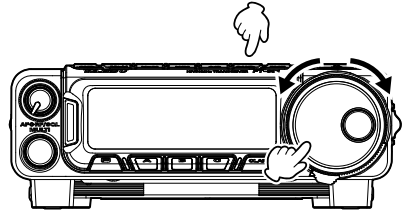

Begin Using Your New Transceiver

Setting the Operating Frequency

Rotate the **DIAL** knob to set the frequency. Rotate clockwise to increase the operating frequency and rotate counter-clockwise to decrease the operating frequency.

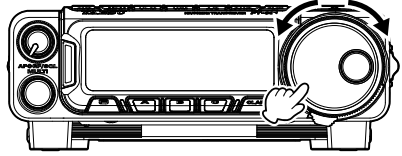

- Two settings, one “normal” and one “fast”, are available for each operating mode. Pressing the ④ **[FAST]** key engages the “Fast” tuning selection (see table below).

Operating Mode	1 Step	1 Step (FAST key)	1 Dial Rotation	1 Dial Rotation (FAST key)
SSB, AM	10 Hz	100 Hz	2 kHz	20 kHz
CW, RTTY, DATA	5 Hz	100 Hz	1 kHz	20 kHz
FM	100 Hz	1 kHz	20 kHz	200 kHz

- The Main Tuning Dial tuning step default settings are: SSB,AM (10 Hz); CW/RTTY/ DATA (5 Hz); and FM (100 Hz). The step settings may be changed according to operator preference via MENU items “14-02” to “14-05”.

Changing frequency up and down quickly with the MULTI function Knob

Press the ⑰ **MULTI** function knob, and then rotate it to adjust the frequency up and down.

NOTE: If the frequency is not changed by rotating the ⑰ **MULTI** function knob, press the ⑰ **MULTI** function knob repeatedly to restore the up and down function.

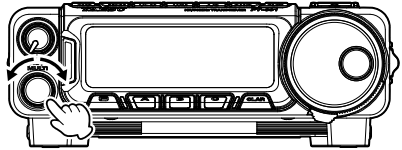

- The frequency steps can be changed via Menu mode “14-01 **[QUICK DIAL]**”, “14-06 **[AM CH STEP]**” and “14-07 **[FM CH STEP]**”.

Operating Mode	Frequency Step
SSB, CW, RTTY, DATA	50, 100, 500 (kHz)
AM	2.5, 5 , 9, 10, 12.5, 25 (kHz)
FM	5 , 6.25, 10, 12.5, 15, 20, 25 (kHz)

(Default: **Bold Italic**)

Begin Using Your New Transceiver

Using the UP/DWN keys of the Supplied MH-31A8J Hand Microphone

The **UP/DWN** keys on the supplied MH-31A8J Hand Microphone may also be used to manually scan the frequency upward or downward.

In modes other than AM/FM, the frequency changes by the same step as the main dial.

When the microphone **[FST]** key is pressed, the tuning rate increases by a factor of ten, in the same manner as the transceiver top panel **④ [FAST]** key.

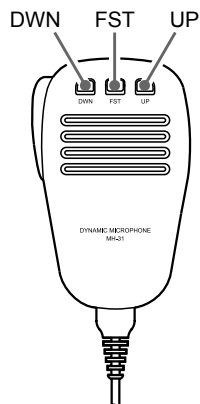

Mode Selection

1. Press and hold the **⑤ [BAND(MODE)]** key for one second.

The "MODE SELECT" screen will appear in the display.

2. Rotate the **DIAL** knob to select the desired radio operating mode.

The selections available are:

... ⇔ SSB ⇔ CW ⇔ RTTY ⇔
⇔ DATA ⇔ AM ⇔ FM ⇔ ...

NOTE: When the desired radio operating mode is selected, the display will automatically return to normal operation after 0.5 second.

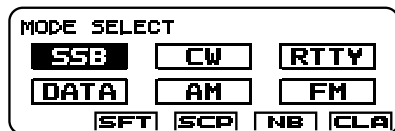
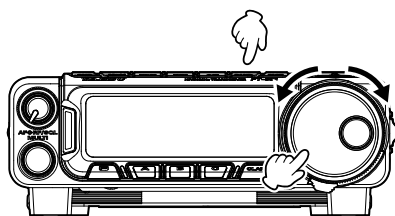

- After changing the selected operating mode on an amateur band, that same mode will automatically be selected when returning to that band.

Begin Using Your New Transceiver

Transmission (SSB/AM/FM mode)

1. Press the microphone **PTT** switch to begin transmitting; speak into the microphone in a normal voice level.
 - The ② TX/BUSY indicator will glow red during transmission.
 - Normally, the factory default microphone gain setting will provide a good transmit audio level.
 - To adjust the microphone gain, utilize Menu mode “**16-07 [SSB MIC GAIN]**”, “**16-08 [AM MIC GAIN]**” or “**16-09 [FM MIC GAIN]**”.
 - When transmitting in the AM mode, set a maximum (carrier) power output of 25 Watts via Menu mode “**16-02 [HF AM PWR]**” or “**16-05 [50M AM PWR]**”.
2. Release the **PTT** switch to return to receive mode.

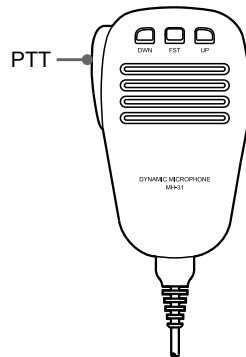

QMB (Quick Memory Bank) Channels

The Quick Memory Bank consists of five memories independent from the regular and PMS memories. The QMB memories can quickly store operating parameters for later recall.

QMB Channel Storage

1. Tune in the desired frequency and set the operating mode on VFO-A.
2. Press and hold in the ⑩ [QMB] key until “beeps” are heard. The beep provides audible confirmation that the data has been stored into the QMB memory.

Repeated one second presses of the ⑩ [QMB] key will write the VFO-A contents to successive QMB memories. Once all five QMB memories have data on them, previous data will be overwritten on a first-in, first-out basis.

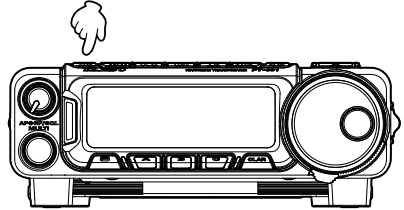

QMB Channel Recall

1. Press the ⑩ [QMB] key momentarily. The current QMB channel data will be shown on the frequency display area. The “QMB” icon will appear on the LCD.
2. Repeated brief presses of the ⑩ [QMB] key will toggle through the QMB channels.



QMB Channel

Erasing QMB Data

1. Press the ⑪ [F] key to find the “FUNCTION-2” list screen.
2. Rotate the ⑰ [MULTI] function knob to select “QMB”.
3. Press the ⑰ [MULTI] function knob to display the “QMB CHANNEL” list screen.
4. Rotate the ⑰ [MULTI] function knob to select the memory channel that you would like to erase.
5. Press and hold the ⑫ [C](ERS) key for one second or press the ⑰ [MULTI] function knob, to erase the contents of the selected QMB channel.
6. To exit from QMB mode and return to the VFO mode, press the ⑫ [A](BCK) key.

Operating Instructions 1

DIAL knob Lock

The **DIAL** knob may be locked to prevent accidental frequency change.

To lock the **DIAL** knob, press the ③ [PWR/LOCK] key.

The “LOCK” icon will appear on the LCD.

To unlock the **DIAL** setting, and restore normal tuning, press the ③ [PWR/LOCK] key again.

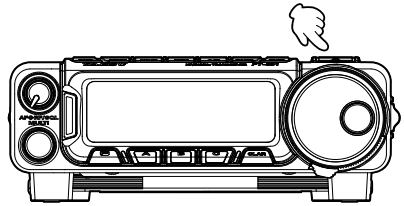

NB (Noise Blanker) (SSB/CW/RTTY/DATA/AM Modes)

The FT-891 includes an effective IF Noise Blanker, which can significantly reduce noise caused by automotive ignition systems.

1. Press the assigned ⑫ [C](NB) key to turn the Noise Blanker ON/OFF (When turning ON, **NB** and **NB** will appear), the blanking level pop-up screen will be displayed.

NOTE: The noise blanker is most effective on certain pulse type noise, it may not have a pronounced effect on other types of noise.

- If the “NB” function is not assigned to an ⑫ [A], [B] or [C] key, press the ⑪ [F] key

repeatedly to find the “FUNCTION-2” list screen. ➡ Rotate the ⑰ **MULTI** function knob to select “NB” ➡ Press and hold the ⑫ [A], [B] or [C] key to assign the function

- Rotate the ⑰ **MULTI** function knob to select “NB” in the “FUNCTION-1” list screen, and then press the knob, to switch the Noise Blanker function ON/OFF.

2. When The blanking level pop-up screen is displayed, rotate the ⑰ **MULTI** function knob to adjust the blanking level to the point where the offending noise is best reduced or eliminated.

NOTE: Increasing the noise blanking level may distort the audio.

To reset the blanking level to the factory default value, press and hold the ⑰ **MULTI** function knob.

3. Press any key, except the ⑫ [A], [B], [C], ⑬ [CLAR] keys, or the ⑰ **MULTI** function knob, to save the new setting and return to normal operation.

- When “**NB**” is shown (after pressing the ⑫ [C](NB) key), rotate the ⑰ **MULTI** function knob to adjust the blanking level. The blanking level may also be adjusted from the “FUNCTION-1” list screen (see page 46).

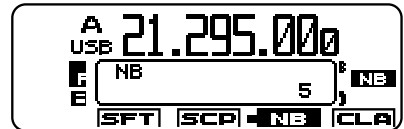
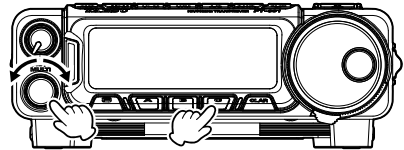

Clarifier (Offsets the receive frequency on the SSB/CW mode)

The **13** [CLAR] key and **17** MULTI function knob are used to offset the receive frequency, the transmit frequency, or both, from the VFO-A frequency setting. A small four digit indication on the display will show the current Clarifier offset. The Clarifier functions on the FT-891 allow offsetting the receive and transmit frequencies (up to ± 9.998 kHz), without actually re-tuning, and then activating it by pressing Clarifier **13** [CLAR] key. This feature is ideal for following a drifting station, or for setting the small frequency offsets sometimes utilized in DX “Split” work.

- To change the clarifier operation (RX/TX/TRX), utilize Menu mode “05-18 [CLAR SELECT]”. The factory default setting is “RX”.
- The RX clarifier does not change the transmit frequency, but permits slight adjustment of the receiver for improved audio.
- Remember to reset the Clarifier offset to zero when the QSO is completed, so the transmit and the receive frequencies will be combined again.

Here is the technique for utilizing the Clarifier:

1. Press the **13** [CLAR] key. The programmed offset will be applied to the receive frequency.
2. Rotation of the **17** MULTI function knob will allow adjustment of the initial offset on the fly. Offsets of up to ± 9.998 kHz may be set using the Clarifier.
3. To cancel Clarifier operation, press the **13** [CLAR] key.

- Turning the Clarifier off merely cancels the application of the programmed offset from the receive and/or the transmit frequencies. To clear the Clarifier offset, and reset it to “zero”, press and hold the **17** MULTI function knob.

- To change the clarifier operation (RX/TX/TRX), utilize Menu mode “05-18 [CLAR SELECT]”.

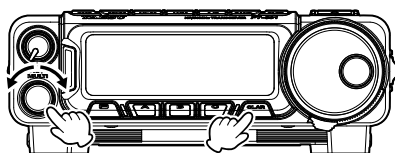

RX Clarifier

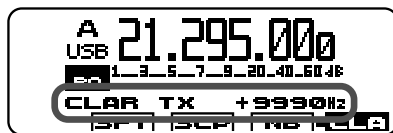

TX Clarifier



TRX Clarifier

Operating Instructions 3

IF SHIFT Operation (SSB/CW/RTTY/DATA Modes)

IF SHIFT permits moving the DSP filter passband higher or lower, without changing the pitch of the incoming signal, and thus reduces or eliminates interference. Because the tuned carrier frequency is not varied, there is no need to retune the operating frequency to eliminate the interference. The total passband tuning range for the IF SHIFT system is ± 1.2 kHz.

1. Press the assigned **(12) [A](SFT)** key to activate the IF SHIFT (**SFT** will appear), the SHIFT adjustment pop-up screen will be displayed.

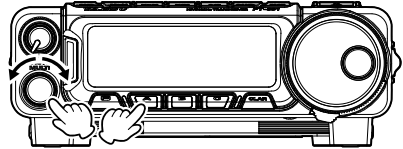

- If the IF SHIFT function is not assigned to an **(12) [A]**, **[B]** or **[C]** key, press **(11) [F]** key repeatedly to find the "FUNCTION-1" list screen. **▶▶▶** Rotate the **(17) MULTI** function knob to select the "SFT" **▶▶▶** Press and hold any of the **(12) [A]/[B]/[C]** keys to assign the IF SHIFT function.

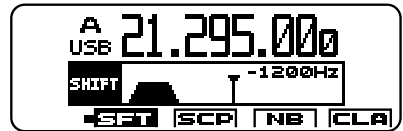

- Rotate the **(17) MULTI** function knob to select "SFT" in the "FUNCTION-1" list screen, and then press the knob, to switch the IF SHIFT function ON/OFF.
2. Rotate the **(17) MULTI** function knob to the left or right to reduce interfering signals.
NOTE: To reset the IF SHIFT tuning to the factory default value, press and hold the **(17) MULTI** function knob.
 3. Press any key except the **(12) [A]**, **[B]**, **[C]**, **(13) [CLAR]** keys, or the **(17) MULTI** function knob to save the new setting and return to normal operation.
 - Press the **(12) [A](SFT)** key, while the "**SFT**" indicator is displayed, and then rotate the **(17) MULTI** function knob to adjust the IF SHIFT tuning. The IF SHIFT may also be adjusted by accessing the "FUNCTION-1" list screen (see page 46).

Referring to Figure (A), note the depiction of the IF DSP filter as the thick line, with **(17) MULTI** function knob in the 12 o'clock position. In Figure (B), an interfering signal has appeared inside the original passband. In Figure (C), you can see the effect of rotating the **(17) MULTI** function knob. The interference level is reduced by moving the filter passband so that the interference is outside of the passband.

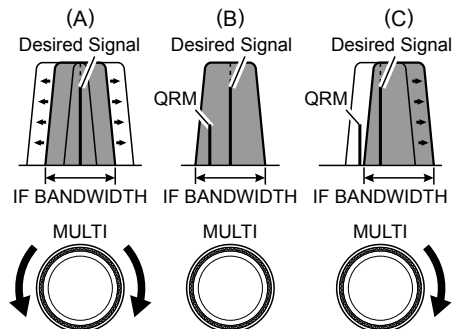

Meters

The following function information can be displayed on the meter in the transmit mode.

- PO** : Displays transmitter output power
- ALC** : Displays ALC voltage
- SWR** : Displays Standing Wave Ratio
- COMP** : Displays the speech processor compression level
- IDD** : Displays the drain current of the final stage FET transistors

1. Press the **(11) [F]** key repeatedly to find the “FUNCTION-2” list screen.
2. Rotate the **(17) MULTI** function knob to select the “MTR”.
3. Press the **(17) MULTI** function knob to activate the meters function.
4. When the Meter information screen is appeared, rotate and press the **(17) MULTI** function knob to select the desired information.
When the desired information is set, the display will return to “FUNCTION-2” list screen automatically.
5. Press and hold the **(11) [F]** key, or rotate the **(14) MAIN DIAL**, to return to normal operation.

VOX

The VOX (Voice Operated Xmit) circuit will engage the transmitter automatically when you speak into the microphone.

Press the **(11) [F]** key to find the “FUNCTION-1” list screen. ➡ Rotate the **(17) MULTI** function knob to select “VOX”. ➡ Press the **(17) MULTI** function knob to switch “VOX” ON or OFF.

Speech Processor

The Speech Processor increases the average power output while operating in the SSB mode. Press the **(11) [F]** key repeatedly to find the “FUNCTION-1” list screen. ➡ Rotate the **(17) MULTI** function knob to select “PRC”. ➡ Press the **(17) MULTI** function knob to display the compression level pop-up screen. ➡ Rotate the **(17) MULTI** function knob to adjust the compression level.

Parametric Microphone Equalizer

In the SSB and AM transmit modes, the Three-Band Parametric Microphone Equalizer may be used to provide precise, independent control over the low, mid and treble frequency ranges in the voice waveform. Press the **(11) [F]** key repeatedly to find the “FUNCTION-2” list screen. ➡ Rotate the **(17) MULTI** function knob to select “MEQ”. ➡ Press the **(17) MULTI** function knob to switch the microphone equalizer ON or OFF.

Scope

The Scope function provides a spectrum display of the band conditions. Both strong and weak signals can be clearly displayed on the LCD display. In the “Manual mode”, the scope frequency spectrum is scanned one time and displayed. In the “Continuous Sweeping mode”, the scope spectrum is repeatedly swept and displayed. The scope sweep and span may be optimized according to your preferences and purposes.

NOTE: Since the FT-891 has only one receiver the audio will be muted during the Continuous sweeping mode.

1. Press the assigned **(12) [B](SCP)** key to display the band conditions (spectrum).

- If the SCOPE function is not assigned to an **(12) [A]**, **[B]** or **[C]** key, follow the instruction below.

Press the **(11) [F]** key repeatedly to find the “FUNCTION-2” list screen. **▶▶** Rotate the **(17) MULTI** function knob to select “SCP” **▶▶▶** Press and hold any of the **(12) [A]/[B]/[C]** keys to assign this function.

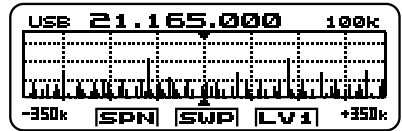
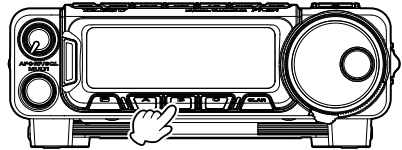

- Rotate the **(17) MULTI** function knob to select “SCP” in the “FUNCTION-2” list screen, and then press the knob, to switch the SCOPE function ON/OFF. The band conditions (spectrum) will appear. Press and hold the **(11) [F]** key to return to normal operation.

2. Press, or press and hold the **(12) [B](SCP)** key, to sweep in the Manual mode or the Continuous sweep mode.

Manual mode (default)

Each time the **(12) [B](SWP)** key is pressed, a new scan of the spectrum scope is shown on the LCD display, and then the receiver audio returns to the speaker.

Continuous sweeping mode

Press and hold the **(12) [B](SWP)** key for one second. The audio is muted and the spectrum scope is scanned continuously. Press **(12) [B](SWP)** key to stop the scanning.

- While the Spectrum Scope is activated, press the **(12) [A](SPN)** key to change the displayed bandwidth. Available selections are 750 kHz (default), 375 kHz, 150 kHz, 75 kHz, or 37.5 kHz ranges.
 - While the Spectrum Scope is activated, press the **(12) [C](LV1/LV2/LV3)** key to change the reference level.
 - The sweeping interval may be set in Menu mode “**13-01 [SCP START CYCLE]**”.
 - Width of scope display may be set in Menu mode “**13-02 [SCP SPAN FREQ]**”.
3. Press one of the **(11) [F]/ (13) [CLAR]/ (9) [M▶V]/ (8) [V▶M]/ (7) [V/M]** keys to return to normal operation.

Operation on 60-Meter (5 MHz) Band (U.S. and U.K. Version Only)

The recently authorized 60-meter band is covered, in the FT-891, by fixed memory channels. These channels are set to USB or CW, and they appear between the “last” PMS channel (“P9U”) and the first “regular” memory channel (“M01”):

1. While operating in the VFO mode, press the **⑦ [V/M]** key to enter the Memory mode.
2. Rotate the **⑰ MULTI** function knob to select the desired memory channel.
Memory channels (“501” through “510”) are preprogrammed, at the factory, with the permitted frequencies in the 5 MHz band, and the USB or CW mode is automatically selected on these channels.

NOTE: In each of the following conditions, memory channels may be selected by pressing and then rotating the **⑰ MULTI** function knob:

- When the mark is indicated to the left of the function key status icon.
- When the display of channel number status is “501” (example of channel number “501”).

3. To exit from 60-meter (5 MHz) operation and return to the VFO mode, just press the **⑦ [V/M]** or **⑥ [A/B]** key.

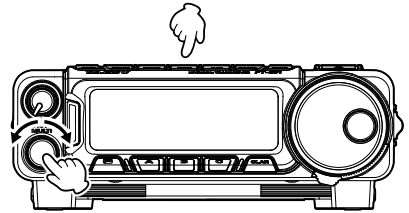

Channel Number

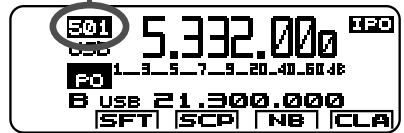

Channel Number



Mark → **[NB]**

Channel Number	Frequency	
	U.S. Version	U.K. Version
501	5.332000 MHz (SSB)	5.260000 MHz (SSB)
502	5.348000 MHz (SSB)	5.280000 MHz (SSB)
503	5.358500 MHz (SSB)	5.290000 MHz (SSB)
504	5.373000 MHz (SSB)	5.368000 MHz (SSB)
505	5.405000 MHz (SSB)	5.373000 MHz (SSB)
506	5.332000 MHz (CW)	5.400000 MHz (SSB)
507	5.348000 MHz (CW)	5.405000 MHz (SSB)
508	5.358500 MHz (CW)	-
509	5.373000 MHz (CW)	-
510	5.405000 MHz (CW)	-

Memory Operation

Most Memory operation will be conducted in the “regular” memory registers. There are 99 memory channels available for storage and recall of your desired essential frequencies.

Normal Memory Storage

1. In the VFO mode, select the frequency, mode, and status, the values you want to have stored.
2. Press the **8 [V▶M]** key to display the “MEMORY CHANNEL” list screen, which may be used to find an unused memory channel. Rotate the **17 MULTI** function knob to select the channel number on which you wish to store the current frequency data.
3. Press the **8 [V▶M]** key to store the frequency and other data into the selected memory channel.

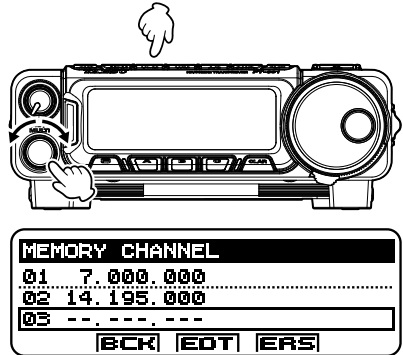

For details about operation of the following functions, refer to the Advanced Manual (download from the Yaesu website).

Naming a Memory Channel

You may also append an alphanumeric “Tag” (label) to each memory, to aid in recollection of the channel’s use (such as club name, etc.).

Memory Groups

Memory channels may be arranged into as many as six convenient groups, for easier identification and selection.

Memory Channel Recall

1. While operating in the VFO mode, press the **⑦ [V/M]** key to enter the Memory mode.
2. Rotate the **⑰ MULTI** function knob to select the desired memory channel.

NOTE: In each of the following conditions, memory channels may be selected by pressing and then rotating the **MULTI** function knob:

- When the mark is indicated to the left of the function key status icon.
- While operating on a memory channel, you may tune off of the original memory channel frequency by rotating the DIAL knob; the “Memory Channel Number” will be replaced by one which indicates “MT” (Memory Tune). Press the **⑦ [V/M]** key to return to the original memory channel frequency.
3. To exit from memory mode and return to the VFO mode, press the **⑦ [V/M]** or **⑥ [A/B]** key.

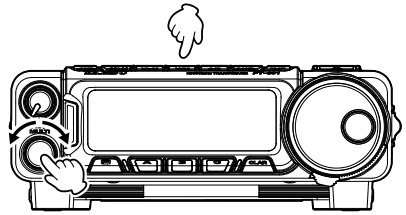

Memory Channel

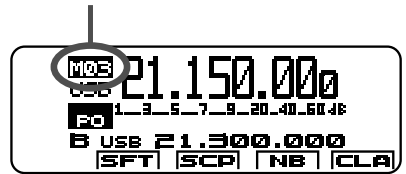

The example of channel number “M03”

Memory Tune

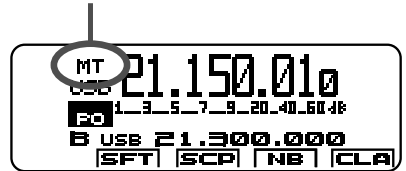

Moving Memory Data to the VFO-A

Data stored on memory channels can easily be copied to VFO-A.

1. Press the **⑨ [M▶V]** or **⑧ [V▶M]** key to display the “MEMORY CHANNEL” list screen.
2. Rotate the **MULTI** function knob to select the desired memory channel.
3. Pressing the **⑨ [M▶V]** key, copies the data from the selected memory to VFO-A. Previous data in VFO-A will be overwritten.

Memory Operation

Erasing Memory Channel Data

1. Press the ⑨ [M▶V] or ⑧ [V▶M] key to display the “MEMORY CHANNEL” list screen.
2. Rotate the ⑰ MULTI function knob to select the memory channel that is to be erased.

NOTE: The FT-891 cannot erase memory channel “01” (and channels “501” through “510”: U.S. version).

3. Press the ⑫ [C](ERS) key to erase the contents of the selected memory channel.
4. To exit from memory mode and return to the VFO-A mode, press the ⑫ [A](BCK) key.

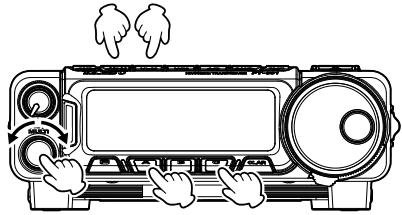

Restoring Memory Channel Data

If you make a mistake and wish to restore the memory contents, repeat step (3) above.

You may scan either the VFO or the memories of the FT-891, and the radio will halt scanning on any frequency with a signal strong enough to open the receiver squelch.

VFO Scanning

1. Set VFO-A to the frequency on which you would like to begin scanning.
2. The ⑯ [RF/SQL] knob may be changed from the “RF” Function to the “SQL” Function via Menu mode “05-05 [RF/SQL VR]”.
3. Rotate the [RF/SQL] knob so that the background noise is just silenced.
4. Press and hold in the microphone [UP] or [DWN] key for one second to start scanning in the specified direction on the VFO frequency.

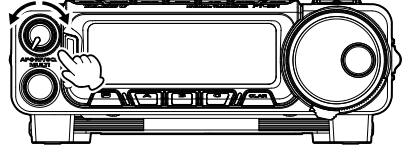

NOTE: Set the “Microphone Automatic Scanning” function to ON or OFF via Menu Mode “05-15 [MIC SCAN]”.

5. If the scanner halts on an incoming signal, the decimal point between the “MHz” and “kHz” digits of the frequency display will blink.

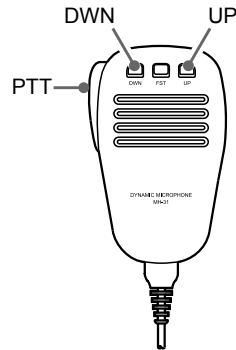

- If the incoming signal disappears, scanning will resume in about five seconds.
 - If the scan has paused on a signal, pressing the microphone [UP] or [DWN] key, will cause scanning to resume instantly.
 - If the Main Tuning **DIAL** knob is rotated while scanning is in progress, the scanning will continue up or down in frequency according to the direction of the **DIAL** Knob rotation. (in other words, if the dial is rotated to the left when scanning toward a higher frequency, the direction of the scan will reverse.)
 - On the SSB/CW and SSB-based Data modes, the scanner will pause on a received signal, then will step across the signal very slowly, giving you time to stop the scan, if you like. However, In these modes on the VFO, the scanner does not stop.
6. To cancel scanning, press the **PTT** switch.
 - If you press the microphone **PTT** switch during scanning, the scanner will halt at once. However, pressing the **PTT** switch during scanning will not cause transmission.

Scan Resume Options

The manner in which the scanner resumes after it has paused on a signal may be selected by using Menu mode “05-16 [MIC SCAN RESUME]”.

Scanning Operation

Memory Scanning

1. The ⑩ [RF/SQL] knob may be changed from the “RF” Function to the “SQL” Function via Menu mode “05-05 [RF/SQL VR]”.
2. Set the transceiver to the “Memory” mode by pressing the ⑦ [V/M] key, if necessary.

3. Rotate the ⑩ [RF/SQL] knob so that the background noise is just silenced.
4. Press and hold in the microphone [UP] or [DWN] key for one second to start scanning in the specified direction.

NOTE: Set the “Microphone Automatic Scanning” function to ON or OFF via Menu mode “05-15 [MIC SCAN]”.

- During Memory Group operation, only the channels within the current Memory Group will be scanned.
5. If the scanner halts on an incoming signal, the decimal point between the “MHz” and “kHz” digits of the frequency display will blink.
 - If the incoming signal disappears, scanning will resume in about five seconds.
 - If the scan has paused on a signal, pressing the microphone [UP] or [DWN] key, will cause scanning to resume instantly.
 - If the Main Tuning DIAL knob is rotated while scanning is in progress, the memory channel scanning will continue up or down in accordance with the direction of the DIAL Knob rotation. (In other words, if the dial is rotated to the left when scanning toward a higher channel number, the direction of the scan will reverse.)
 6. To cancel scanning, press the PTT switch.
 - If the microphone PTT switch is pressed during scanning, the scanner will halt at once. However, pressing the PTT switch during scanning will not cause transmission.

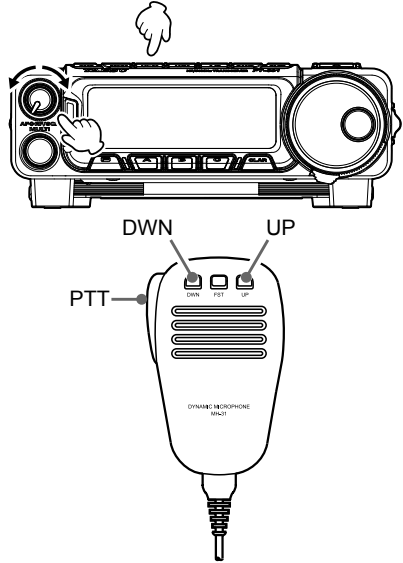

Scan Resume Options

The manner in which the scanner resumes after it has paused on a signal may be selected by using Menu mode “05-16 [MIC SCAN RESUME]”.

Programmable Memory Scan (PMS)

When scanning the dedicated PMS memory channels, only the frequencies within the specified frequency range will be scanned.

NOTE: For additional details, refer to the Advanced Manual which may be downloaded from the Yaesu website.

Transmission (CW mode)

1. Before starting, connect a key or keyer paddle line to the rear panel KEY jack.
2. Press and hold the ⑤ [BAND(MODE)] key for one second.
The “MODE SELECT” screen will appear in the display.
3. Rotate the **DIAL** knob to select the “CW” mode.
4. Press the ⑪ [F] key to find the “CW SETTING” list screen.
5. Rotate the ⑰ **MULTI** function knob to select “BK-IN”.
6. Press the ⑰ **MULTI** function knob to engage the “break-in” system.
7. When using the keyer paddle, rotate the ⑰ **MULTI** function knob to select “KEYER”.
8. Press the ⑰ **MULTI** function knob to engage the built-in Electronic Keyer.
9. Press and hold the ⑪ [F] key for one second to exit the “CW SETTING” list screen and resume normal operation.
10. When the key or the keyer paddle is pressed, the transmitter will automatically be engaged.
11. When the key or paddle is released, the receiver audio will return, after a brief delay.

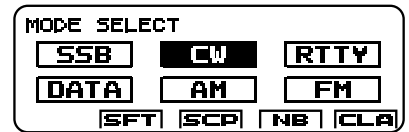
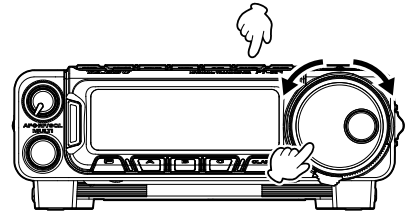
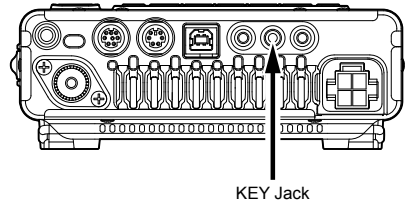

Adjusting the CW delay time

The CW “hang time” (the delay after the last character is sent, until the transceiver returns to the receive mode) can be adjusted via MENU item “07-09 [CW BK-IN DELAY].”

Adjusting the Sidetone volume level

The CW sidetone volume level can be adjusted via the “FUNCTION-1” list screen.

NOTE: For additional details, refer to the Advanced Manual which may be downloaded from the Yaesu website.

Adjusting the Keyer Speed

The keyer speed can be adjusted via the “CW SETTING” list screen.

NOTE: For additional details, refer to the Advanced Manual which may be downloaded from the Yaesu website.

Setting Modes

Setting Modes Display

Press the **(11) [F]** key momentarily to step through the Setting Modes as follows:

➡➡➡ FUNCTION-1 ➡➡➡ FUNCTION-2 ➡➡➡ CW SETTING ➡➡➡

The FM SETTING, the REC SETTING and the ATAS SETTING function screens may be enabled via Menu modes “05-10”, “05-11” or “05-12”. With the factory default setting, These functions are not displayed on the LCD When the **(11) [F]** key is pressed.

Once the function is set, it is not usually changed. Press and hold the **(11) [F]** key to activate the Menu mode.

Using the Setting Modes

1. Repeatedly press the **(11) [F]** key momentarily until the desired function appears.
2. Rotate the **(17) MULTI** function knob to select the desired function.
3. Press (or press and hold) the **(17) MULTI** function knob to switch the function on or off.

- Depending on the function, the pop-up screen appears by switching the function “ON”.

The setting values may be changed by rotating the **MULTI** function Knob.

- While the pop-up screen is displayed, press the **(17) MULTI** function knob to close the pop-up screen.

4. Press and hold the **(11) [F]** key for one second, or rotate the **DIAL** knob to exit the “Setting Modes” screen and resume normal operation.

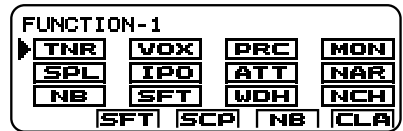
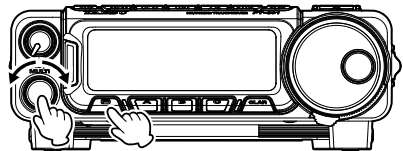

Changing the function assigned to the [A]/[B]/[C] keys

The default setting are:

- ⑫ [A](SFT) key: IF SHIFT function
- ⑫ [B](SCP) key: The SCOPE function
- ⑫ [C](NB) key: Noise Blanker function

1. Repeatedly press the ⑪ [F] key momentarily until the desired function appears.
2. Rotate the ⑰ MULTI function knob to select the desired function.
3. Press and hold any of the ⑫ [A]/[B]/[C] keys to assign the function.

The desired function is saved and the display returns to normal operation.

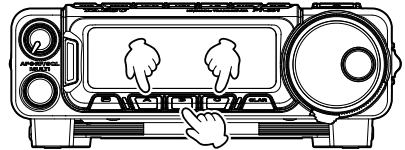
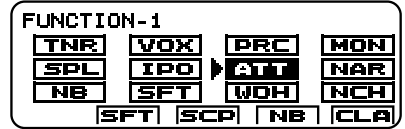
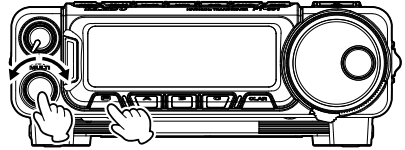

NOTE: Examples of the Function ⑫ [A]/[B]/[C] key display as shown in the case of the Noise Blanker

[NB] : Function "OFF".

[NB] : Function "ON".

- ▀ **[NB]** : Function "ON" and then turn the ⑰ MULTI function knob to change the assigned feature setting.

Setting Modes

FUNCTION-1

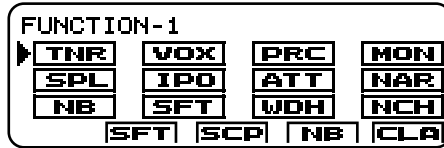

	⑰ MULTI Knob	Function
TNR	Press	Enable/Disable the optional FC-40/FC-50 Automatic Antenna tuner or ATAS-120A Auto Active-Tuning Antenna System.
VOX	Press	Enable/Disable the VOX (voice-operated transmitter switching system) in the SSB, AM, FM and DATA modes.
PRC	Press	<ul style="list-style-type: none"> Activate the speech processor for SSB transmissions, the processor level pop-up screen will appear. Rotate the MULTI function knob to adjust the processor level (1 - 100), then press the MULTI function knob to close the pop-up screen. Press the MULTI function knob to turn the speech processor OFF.
MON	Press	<ul style="list-style-type: none"> Activate the MONITOR feature, the monitor audio level pop-up screen will appear. Rotate the MULTI function knob to adjust the monitor audio level (0 - 100), then press the MULTI function knob to close the pop-up screen. Press the MULTI function knob to turn the MONITOR feature OFF.
SPL	Press	Enable/Disable Split frequency operation between VFO-A and VFO-B.
	Press and hold	Sets a one-touch +5 kHz offset with respect to the VFO-B frequency.
IPO	Press	Enable/Disable the receiver preamplifier, thereby activating Intercept Point Optimization for improved strong signal overload characteristics.
ATT	Press	Enable/Disable the receiver front-end attenuator, which will reduce all signals and noise by approximately 12 dB.
NAR	Press	Enable/Disable the low-deviation mode.
NB	Press	<ul style="list-style-type: none"> Activate the receiver IF Noise Blanker, the blanker level pop-up screen will appear. Rotate the MULTI function knob to adjust the noise blanker level (0 - 10), then press the MULTI function knob to close the pop-up screen. Press the MULTI function knob to turn the Noise Blanker OFF.
SFT	Press	<ul style="list-style-type: none"> Activate the IF SHIFT feature, the SHIFT adjustment pop-up screen will appear. Rotate the MULTI function knob to the left or right to reduce interfering signals, then press the MULTI function knob to close the pop-up screen. Press the MULTI function knob to turn the IF SHIFT feature OFF.
WDH	Press	<ul style="list-style-type: none"> Activate the WIDTH tuning feature, the WIDTH adjustment pop-up screen will appear. Rotate the MULTI function knob counter-clockwise to narrow the bandwidth and reduce interference, then press the MULTI function knob to close the pop-up screen. Press the MULTI function knob to turn the WIDTH tuning feature OFF.
NCH	Press	<ul style="list-style-type: none"> Activate the IF NOTCH filter feature, the "null" position adjustment pop-up screen will appear. Rotate the MULTI function knob to adjust the "null" position of the Notch filter, then press the MULTI function knob to close the pop-up screen. Press the MULTI function knob to turn the IF NOTCH filter feature OFF.

NOTE: For details, refer to the Advanced Manual (download from the Yaesu website).

FUNCTION-2

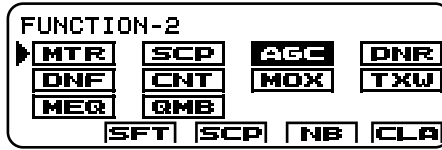

	⑰ MULTI Knob	Function
MTR	Press	Rotate the MULTI function knob to select the display function of the meter in the transmit mode.
SCP	Press	Enable/Disable the Spectrum Scope Monitor feature.
AGC	Press	<ul style="list-style-type: none"> • Activate the receiver AGC system, then rotate the MULTI function knob to select the desired receive AGC recovery time constant. • Press the MULTI function knob to turn the receiver AGC system OFF.
DNR	Press	<ul style="list-style-type: none"> • Activate the DSP Noise Reduction system, the 15 algorithms pop-up screen will appear. Rotate the MULTI function knob to choose one of 15 algorithms that best reduces the noise level, then press the MULTI function knob to close the pop-up screen. • Press the MULTI function knob turn the DSP Noise Reduction system OFF.
DNF	Press	Enable/Disable the DSP Auto Notch Filter.
CNT	Press	<ul style="list-style-type: none"> • Activate the CONTOUR function, the adjustment pop-up screen will appear. Rotate the MULTI function knob to achieve the most natural sounding audio reproduction of the incoming signal, then press the MULTI function knob to close the pop-up screen. • Press the MULTI function knob to turn the CONTOUR function OFF.
MOX	Press and hold	Pressing and holding the MULTI function knob will engage the transmitter.
TXW	Press and hold	During a split operation, to listen on the transmit frequency.
MEQ	Press	Enable/Disable the Parametric Microphone Equalizer.
QMB	Press	To display the “QMB CHANNEL” list screen.

NOTE: For details, refer to the Advanced Manual (download from the Yaesu website).

Setting Modes

CW SETTING

This setting mode is used for the CW mode functions.



	⑰ MULTI Knob	Function
SPEED	Press	Rotate the MULTI function knob to adjust the CW sending speed (4 - 60 wpm).
ZIN	Press	Automatically zero-in the receive frequency to match the received CW signal.
	Press and hold	The CW tone is output from the speaker.
APF	Press	<ul style="list-style-type: none"> • Activate the receiver APF (Audio Peak Filter) function, the adjustment pop-up screen will appear. Rotate the MULTI function knob to set the sound volume to a comfortable level (± 250 Hz), then press the MULTI function knob to close the pop-up screen. • Press the MULTI function knob to turn the APF (Audio Peak Filter) function OFF.
PITCH	Press	Rotate the MULTI function knob to adjust the PITCH (300 - 1050 Hz).
KEYER	Press	Enable/Disable the built-in Electronic Keyer.
BK-IN	Press	Enable/Disable the CW "Semi break-in" operation.

NOTE: For details, refer to the Advanced Manual (download from the Yaesu website).

FM SETTING

This setting mode is used for the FM mode functions.

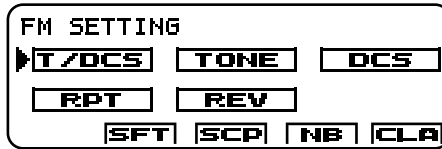

(This screen may be enabled/disabled via Menu Mode "05-10 [FM SETTING]". Default: Disable)

	⑰ MULTI Knob	Function
T/DCS	Press	<ul style="list-style-type: none"> Activate the CTCSS or DCS operation on FM mode, the CTCSS/DCS function selection pop-up screen will appear. Rotate the MULTI function knob to select the desired CTCSS/DCS function, then press the MULTI function knob to close the pop-up screen. Press the MULTI function knob to turn the CTCSS or DCS operation OFF.
TONE	Press	Rotate the MULTI function knob to select the CTCSS tone frequency (see table below), then press the MULTI function knob to close the pop-up screen.
DCS	Press	Rotate the MULTI function knob to select the DCS code (see table below), then press the MULTI function knob to close the pop-up screen.
RPT	Press	Rotate the MULTI function knob to select the offset direction of the uplink frequency shift (+, – or simplex) during FM repeater operation, then press the MULTI function knob to close the pop-up screen.
REV	Press	Reverse the transmit and receive frequencies while working through a repeater.

NOTE: For details, refer to the Advanced Manual (download from the Yaesu website).

CTCSS TONE FREQUENCY (Hz)								
67.0	69.3	71.9	74.4	77.0	79.7	82.5	85.4	88.5
91.5	94.8	97.4	100.0	103.5	107.2	110.9	114.8	118.8
123.0	127.3	131.8	136.5	141.3	146.2	151.4	156.7	159.8
162.2	165.5	167.9	171.3	173.8	177.3	179.9	183.5	186.2
189.9	192.8	196.6	199.5	203.5	206.5	210.7	218.1	225.7
229.1	233.6	241.8	250.3	254.1	-	-	-	-

DCS CODE									
023	025	026	031	032	036	043	047	051	053
054	065	071	072	073	074	114	115	116	122
125	131	132	134	143	145	152	155	156	162
165	172	174	205	212	223	225	226	243	244
245	246	251	252	255	261	263	265	266	271
274	306	311	315	325	331	332	343	346	351
356	364	365	371	411	412	413	423	431	432
445	446	452	454	455	462	464	465	466	503
506	516	523	526	532	546	565	606	612	624
627	631	632	654	662	664	703	712	723	731
732	734	743	754	-	-	-	-	-	-

Setting Modes

REC SETTING

This setting mode is used for the recording functions.

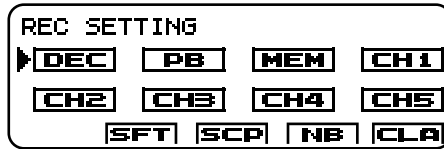

(This screen may be enabled/disabled via Menu Mode "05-11 [REC SETTING]". Default: Disable)

	⑰ MULTI Knob	Function
DEC	Press	Decrement (decrease) the current Contest Number by one number (i.e. from #198 to #197, etc.).
PB	Press	Enable/Disable automatic transmit activation when playing recorded messages.
MEM	Press	Store either a Voice Memory or a Contest Keyer Memory.
CH1	Press	Send the CW message which is prerecorded in CW MEMORY 1.
CH2	Press	Send the CW message which is prerecorded in CW MEMORY 2.
CH3	Press	Send the CW message which is prerecorded in CW MEMORY 3.
CH4	Press	Send the CW message which is prerecorded in CW MEMORY 4.
CH5	Press	Send the CW message which is prerecorded in CW MEMORY 5.

NOTE: For details, refer to the Advanced Manual (download from the Yaesu website).

ATAS SETTING

This setting mode is used when connecting the Active Tuning Antenna "ATAS-120A".



(This screen may be enabled/disabled via Menu Mode "05-12 [ATAS SETTING]". Default: Disable)

	MULTI Knob	Function
▲	Press and hold	Raise the tuned frequency (lower the ATAS-120A antenna).
▼	Press and hold	Lower the tuned frequency (raise the ATAS-120A antenna).

NOTE: For details, refer to the Advanced Manual (download from the Yaesu website).

The FT-891 Menu mode, already described in parts of many previous chapters, is easy to activate and setup. The Menus may be used to configure many of transceiver parameters, some of which have not been detailed previously. Use the following procedure to activate the Menu mode:

1. Press and hold in the **⑪ [F]** key for one second to activate the Menu mode.
2. Rotate the **⑰ MULTI** function knob to select the Menu Item to be adjusted.
3. Press the **⑰ MULTI** function knob, and then rotate it to adjust the selected Menu item.
4. When the adjustment is satisfactory, press the **⑰ MULTI** function knob to save the new setting.
5. Press the **⑪ [F]** key to exit the Menu mode and return to normal operation.

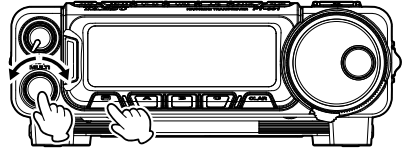

MENU	01-01	AGC
AGC FAST DELAY		300msec
AGC MID DELAY		700msec
AGC SLOW DELAY		3000msec
LCD CONTRAST		8

NOTE: For additional details, refer to the Advanced Manual which may be downloaded from the Yaesu website.

Menu / Item		Available Values	Default
AGC			
	01-01	AGC FAST DELAY	20 - 4000 (msec)
			300msec
	01-02	AGC MID DELAY	20 - 4000 (msec)
			700msec
	01-03	AGC SLOW DELAY	20 - 4000 (msec)
			3000msec
DISPLAY			
	02-01	LCD CONTRAST	1 - 15
			8
	02-02	DIMMER BACKLIT	1 - 15
			8
	02-03	DIMMER LCD	1 - 15
			8
	02-04	DIMMER TX/BUSY	1 - 15
			8
	02-05	PEAK HOLD	OFF/0.5/1.0/2.0 (sec)
			OFF
	02-06	ZIN LED	ENABLE/DISABLE
			DISABLE
	02-07	POP-UP MENU	UPPER/LOWER
			LOWER
DVS			
	03-01	DVS RX OUT LVL	0 - 100
			50
	03-02	DVS TX OUT LVL	0 - 100
			50
KEYER			
	04-01	KEYER TYPE	OFF/BUG/ELEKEY-A/ELEKEY-B/ ELEKEY-Y/ACS
			ELEKEY-B
	04-02	KEYER DOT/DASH	NOR/REV
			NOR
	04-03	CW WEIGHT	2.5 - 4.5
			3.0
	04-04	BEACON INTERVAL	OFF/1 - 240 (sec) (1 sec/step) 270 - 690 (sec) (30 sec/step)
			OFF
	04-05	NUMBER STYLE	1290/AUNO/AUNT/A2NO/ A2NT/12NO/12NT
			1290
	04-06	CONTEST NUMBER	0 - 9999
			1
	04-07	CW MEMORY 1	TEXT/MESSAGE
			TEXT
	04-08	CW MEMORY 2	TEXT/MESSAGE
			TEXT

Menu Mode

	Menu / Item	Available Values	Default	
	04-09	CW MEMORY 3	TEXT/MESSAGE	TEXT
	04-10	CW MEMORY 4	TEXT/MESSAGE	TEXT
	04-11	CW MEMORY 5	TEXT/MESSAGE	TEXT
GENERAL				
	05-01	NB WIDTH	1/3/10 (msec)	3msec
	05-02	NB REJECTION	10/30/50 (dB)	30dB
	05-03	NB LEVEL	0 - 10	5
	05-04	BEEP LEVEL	0 - 100	30
	05-05	RF/SQ/ VR	RF/SQ/SQL	RF
	05-06	CAT RATE	4800/9600/19200/38400 (bps)	4800bps
	05-07	CAT TOT	10/100/1000/3000 (msec)	10ms
	05-08	CAT RTS	ENABLE/DISABLE	ENABLE
	05-09	MEM GROUP	ENABLE/DISABLE	DISABLE
	05-10	FM SETTING	ENABLE/DISABLE	DISABLE
	05-11	REC SETTING	ENABLE/DISABLE	DISABLE
	05-12	ATAS SETTING	ENABLE/DISABLE	DISABLE
	05-13	QUICK SPL FREQ	-20 (kHz) - 0 - 20 (kHz)	5kHz
	05-14	TX TOT	OFF/1 - 30 (min)	OFF (10 min [※])
	05-15	MIC SCAN	ENABLE/DISABLE	ENABLE
	05-16	MIC SCAN RESUME	PAUSE/TIME	TIME
	05-17	REF FREQ ADJ	-25 - 0 - 25	0
	05-18	CLAR SELECT	RX/TX/TRX	RX
	05-19	APO	OFF/1/2/4/6/8/10/12 (h)	OFF
	05-20	FAN CONTROL	NORMAL/CONTEST	NORMAL
MODE AM				
	06-01	AM LCUT FREQ	OFF /100 - 1000 (Hz)	OFF
	06-02	AM LCUT SLOPE	6 / 18 (dB/oct)	6dB/oct
	06-03	AM HCUT FREQ	700 - 4000 (Hz) / OFF	OFF
	06-04	AM HCUT SLOPE	6 / 18 (dB/oct)	6dB/oct
	06-05	AM MIC SELECT	MIC/REAR	MIC
	06-06	AM OUT LEVEL	0 - 100	50
	06-07	AM PTT SELECT	DAKY/RTS/DTR	DAKY
MODE CW				
	07-01	CW LCUT FREQ	OFF /100 - 1000 (Hz)	250Hz
	07-02	CW LCUT SLOPE	6 / 18 (dB/oct)	18dB/oct
	07-03	CW HCUT FREQ	700 - 4000 (Hz) / OFF	1200Hz
	07-04	CW HCUT SLOPE	6 / 18 (dB/oct)	18dB/oct
	07-05	CW OUT LEVEL	0 - 100	50
	07-06	CW AUTO MODE	OFF/50M/ON	OFF
	07-07	CW BFO	USB/LSB/AUTO	USB
	07-08	CW BK-IN TYPE	SEMI/FULL	SEMI
	07-09	CW BK-IN DELAY	30 - 3000 (msec)	200msec
	07-10	CW WAVE SHAPE	2/4 (msec)	4msec
	07-11	CW FREQ DISPLAY	FREQ/PITCH	PITCH
	07-12	PC KEYING	OFF/DAKY/RTS/DTR	OFF
	07-13	QSK DELAY TIME	15/20/25/30 (msec)	15msec

※: European Version.

Menu Mode

Menu / Item		Available Values		Default
MODE DAT				
	08-01	DATA MODE	PSK/OTHERS	PSK
	08-02	PSK TONE	1000/1500/2000 (Hz)	1000Hz
	08-03	OTHER DISP	-3000 - 0 - 3000 (Hz)	0Hz
	08-04	OTHER SHIFT	-3000 - 0 - 3000 (Hz)	0Hz
	08-05	DATA LCUT FREQ	OFF /100 - 1000 (Hz)	300Hz
	08-06	DATA LCUT SLOPE	6 / 18 (dB/oct)	18dB/oct
	08-07	DATA HCUT FREQ	700 - 4000Hz / OFF	3000Hz
	08-08	DATA HCUT SLOPE	6 / 18 (dB/oct)	18dB/oct
	08-09	DATA IN SELECT	MIC/REAR	REAR
	08-10	DATA PTT SELECT	DAKY/RTS/DTR	DAKY
	08-11	DATA OUT LEVEL	0 - 100	50
	08-12	DATA BFO	USB/LSB	LSB
MODE FM				
	09-01	FM MIC SELECT	MIC/REAR	MIC
	09-02	FM OUT LEVEL	0 - 100	50
	09-03	PKT PTT SELECT	DAKY/RTS/DTR	DAKY
	09-04	RPT SHIFT 28MHz	0 - 1000 (kHz)	100kHz
	09-05	RPT SHIFT 50MHz	0 - 4000 (kHz)	1000kHz
	09-06	DCS POLARITY	Tn-Rn/Tn-Riv/Tiv-Rn/Tiv-Riv	Tn-Rn
MODE RTY				
	10-01	RTTY LCUT FREQ	OFF /100 - 1000 (Hz)	300Hz
	10-02	RTTY LCUT SLOPE	6 / 18 (dB/oct)	18dB/oct
	10-03	RTTY HCUT FREQ	700 - 4000 (Hz) / OFF	3000Hz
	10-04	RTTY HCUT SLOPE	6 / 18 (dB/oct)	18dB/oct
	10-05	RTTY SHIFT PORT	SHIFT/DTR/RTS	SHIFT
	10-06	RTTY POLARITY-R	NOR/REV	NOR
	10-07	RTTY POLARITY-T	NOR/REV	NOR
	10-08	RTTY OUT LEVEL	0 - 100	50
	10-09	RTTY SHIFT FREQ	170/200/425/850 (Hz)	170Hz
	10-10	RTTY MARK FREQ	1275/2125 (Hz)	2125Hz
	10-11	RTTY BFO	USB/LSB	LSB
MODE SSB				
	11-01	SSB LCUT FREQ	OFF /100 - 1000 (Hz)	100Hz
	11-02	SSB LCUT SLOPE	6 / 18 (dB/oct)	6dB/oct
	11-03	SSB HCUT FREQ	700 - 4000 (Hz) / OFF	3000Hz
	11-04	SSB HCUT SLOPE	6 / 18 (dB/oct)	6dB/oct
	11-05	SSB MIC SELECT	MIC/REAR	MIC
	11-06	SSB OUT LEVEL	0 - 100	50
	11-07	SSB BFO	USB/LSB/AUTO	AUTO
	11-08	SSB PTT SELECT	DAKY/RTS/DTR	DAKY
	11-09	SSB TX BPF	100-3000/100-2900/200-2800/300-2700/400-2600	300-2700
RX DSP				
	12-01	APF WIDTH	NARROW/MEDIUM/WIDE	MEDIUM
	12-02	CONTOUR LEVEL	-40 - 0 - 20	-15
	12-03	CONTOUR WIDTH	1 - 11	10
	12-04	IF NOTCH WIDTH	NARROW/WIDE	WIDE

Menu Mode

Menu / Item		Available Values	Default	
SCOPE				
	13-01	SCP START CYCLE	OFF/3/5/10 (sec)	OFF
	13-02	SCP SPAN FREQ	37.5/75/150/375/750 (kHz)	750kHz
TUNING				
	14-01	QUICK DIAL	50/100/500 (kHz)	500kHz
	14-02	SSB DIAL STEP	2/5/10 (Hz)	10Hz
	14-03	AM DIAL STEP	10/100 (Hz)	10Hz
	14-04	FM DIAL STEP	10/100 (Hz)	100Hz
	14-05	DIAL STEP	2/5/10 (Hz)	5Hz
	14-06	AM CH STEP	2.5/5/9/10/12.5/25 (kHz)	5kHz
	14-07	FM CH STEP	5/6.25/10/12.5/15/20/25 (kHz)	5kHz
TX AUDIO				
	15-01	EQ1 FREQ	OFF/100 - 700	OFF
	15-02	EQ1 LEVEL	-20 - 0 - 10	5
	15-03	EQ1 BWTH	1 - 10	10
	15-04	EQ2 FREQ	OFF/700 - 1500	OFF
	15-05	EQ2 LEVEL	-20 - 0 - 10	5
	15-06	EQ2 BWTH	1 - 10	10
	15-07	EQ3 FREQ	OFF/1500 - 3200	OFF
	15-08	EQ3 LEVEL	-20 - 0 - 10	5
	15-09	EQ3 BWTH	1 - 10	10
	15-10	P-EQ1 FREQ	OFF/100 - 700	200
	15-11	P-EQ1 LEVEL	-20 - 0 - 10	0
	15-12	P-EQ1 BWTH	1 - 10	2
	15-13	P-EQ2 FREQ	OFF/700 - 1500	800
	15-14	P-EQ2 LEVEL	-20 - 0 - 10	0
	15-15	P-EQ2 BWTH	1 - 10	1
	15-16	P-EQ3 FREQ	OFF/1500 - 3200	2100
	15-17	P-EQ3 LEVEL	-20 - 0 - 10	0
	15-18	P-EQ3 BWTH	1 - 10	1
TX GNRL				
	16-01	HF SSB PWR	5 - 100	100
	16-02	HF AM PWR	5 - 40	25
	16-03	HF PWR	5 - 100	100
	16-04	50M SSB PWR	5 - 100	100
	16-05	50M AM PWR	5 - 40	25
	16-06	50M PWR	5 - 100	100
	16-07	SSB MIC GAIN	0 - 100	50
	16-08	AM MIC GAIN	0 - 100	50
	16-09	FM MIC GAIN	0 - 100	50
	16-10	DATA MIC GAIN	0 - 100	50
	16-11	SSB DATA GAIN	0 - 100	50
	16-12	AM DATA GAIN	0 - 100	50
	16-13	FM DATA GAIN	0 - 100	50
	16-14	DATA DATA GAIN	0 - 100	50
	16-15	TUNER SELECT	OFF/EXTERNAL/ATAS/LAMP	OFF
	16-16	VOX SELECT	MIC/DATA	MIC
	16-17	VOX GAIN	0 - 100	50

Menu / Item		Available Values	Default
16-18	VOX DELAY	30 - 3000 (msec)	500msec
16-19	ANTI VOX GAIN	0 - 100	50
16-20	DATA VOX GAIN	0 - 100	50
16-21	DATA VOX DELAY	30 - 3000 (msec)	100msec
16-22	ANTI DVOX GAIN	0 - 100	0
16-23	EMERGENCY FREQ	ENABLE/DISABLE	DISABLE
RESET			
17-01	RESET	ALL/DATA/FUNC	---
VERSION			
18-01	MAIN VERSION	---	---
18-02	DSP VERSION	---	---
18-03	LCD VERSION	---	---

Specifications

General

Frequency Range:	Tx: 1.8 MHz - 54 MHz (Amateur bands only) Rx: 30 kHz - 56 MHz 1.8 MHz - 54 MHz (Specified performance, Amateur bands only)
Channel Step:	2/5/10 Hz (SSB, CW) 10/100 Hz (AM, FM)
Frequency Stability:	SSB/CW/AM: ±0.5 ppm [14 °F to +122 °F (-10 °C to +50 °C)] FM: ±1 kHz [14 °F to +122 °F (-10 °C to +50 °C)]
Modes of Emission :	A1A (CW), A3E (AM), J3E (LSB, USB), F3E (FM)
Antenna Impedance:	50 Ohms, unbalanced
Supply voltage:	13.8 V DC ±15%, negative ground
Current Consumption (typical):	Rx: 2.0 A (signal present) Tx: 23 A
Operating Temperature Range:	14 °F to +122 °F (-10 °C to +50 °C)
Case Size (W x H x D):	6.1" x 2.0" x 8.6" (155 x 52 x 218 mm) (w/o knobs)
Weight (Approx.):	4.18 lb (1.9 kg)

Transmitter

Power Output:	100 W (40 W AM carrier)
Modulation Type:	J3E (SSB): Balanced, A3E (AM): Low-Level, F3E (FM): Variable Reactance
Maximum Deviation:	±5.0 kHz (Wide) ±2.5 kHz (Narrow)
Spurious Radiation:	Better than -50 dB (1.8 MHz - 30 MHz Amateur bands) Better than -63 dB (50 MHz Amateur bands)
Microphone Impedance:	600 Ohms (200 Ohms to 10 k Ohms)

Receiver

Circuit Type:	SSB/CW/AM: Triple-conversion Superheterodyne FM: Double Conversion Superheterodyne	
Intermediate Frequencies:	SSB/CW/AM: 1st: 69.450 MHz 2nd: 450 kHz 3rd: 24 kHz FM: 1st: 69.450 MHz 2nd: 450 kHz	
Sensitivity:	SSB/CW (S/N 10 dB) 0.16 μ V (1.8 MHz - 30 MHz) 0.16 μ V (50 MHz - 54 MHz) AM (S/N 10 dB) 5 μ V (0.5 MHz - 1.8 MHz) 1.6 μ V (1.8 MHz - 30 MHz) 1.6 μ V (50 MHz - 54 MHz) FM (12 dB SINAD) 0.35 μ V (29 MHz, 50 MHz - 54 MHz)	
Selectivity	Mode	-6 dB -60 dB
	SSB/CW	2.4 kHz or better 3.6 kHz or less
	CW-N	500 Hz or better 750 Hz or less
	AM	6 kHz or better 15 kHz or less
	FM	12 kHz or better 30 kHz or less (-50dB)
	FM-N	9 kHz or better 25 kHz or less (-50dB)
Maximum AF Output:	2.5 W into 4 ohms with 10% THD	
Audio Output Impedance:	4 Ohms to 16 Ohms (8 Ohms: nominal)	
Conducted Radiation:	Less than 4 nW	

Specifications are subject to change, in the interest of technical improvement, without notice or obligation, and are guaranteed only within the amateur bands.

Symbol placed on the equipment

== Direct current

This equipment has been tested and found to comply with the limits for a Class B digital device, pursuant to Part 15 of the FCC Rules. These limits are designed to provide reasonable protection against harmful interference in a residential installation. This equipment generates, uses and can radiate radio frequency energy and, if not installed and used in accordance with the instructions, may cause harmful interference to radio communications. However, there is no guarantee that interference will not occur in a particular installation.

If this equipment does cause harmful interference to radio or television reception, which can be determined by turning the equipment off and on, the user is encouraged to try to correct the interference by one or more of the following measures:

- Increase the separation between the equipment and receiver.
- Connect the equipment into an outlet on a circuit different from that to which the receiver is connected.
- Consult the dealer or an experienced radio/TV technician for help.

1. Changes or modifications to this device that are not expressly approved by YAESU MUSEN could void the user's authorization to operate this device.
2. This device complies with part 15 of the FCC Rules. Operation is subject to the following two conditions: (1) This device may not cause harmful interference, and (2) this device must accept any interference including received, interference that may cause undesired operation.
3. The scanning receiver in this equipment is incapable of tuning, or readily being altered, by the User to operate within the frequency bands allocated to the Domestic public Cellular Telecommunications Service in Part 22.

This device complies with Industry Canada license-exempt RSS standard(s). Operation is subject to the following two conditions: (1) this device may not cause interference, and (2) this device must accept any interference, including interference that may cause undesired operation of the device.

Le présent appareil est conforme aux CNR d'Industrie Canada applicables aux appareils radio exempts de licence. L'exploitation est autorisée aux deux conditions suivantes : (1) l'appareil ne doit pas produire de brouillage, et (2) l'utilisateur de l'appareil doit accepter tout brouillage radioélectrique subi, même si le brouillage est susceptible d'en compromettre le fonctionnement.

DECLARATION BY MANUFACTURER

The Scanner receiver is not a digital scanner and is incapable of being converted or modified to a digital scanner receiver by any user.

WARNING: MODIFICATION OF THIS DEVICE TO RECEIVE CELLULAR RADIOTELEPHONE SERVICE SIGNALS IS PROHIBITED UNDER FCC RULES AND FEDERAL LAW.

CAN ICES-3 (B) / NMB-3 (B)

European Users should note that operation of this unit in Transmit mode requires the operator to have a valid Amateur Radio License from their respective Countries Amateur Radio Licensing Authority for the Frequencies and Transmitter Power levels that this Radio transmits on. Failure to comply may be unlawful and liable for prosecution.

Disposal of your Electronic and Electric Equipment

Products with the symbol (crossed-out wheeled bin) cannot be disposed as household waste. Electronic and Electric Equipment should be recycled at a facility capable of handling these items and their waste by products.

In EU countries, please contact your local equipment supplier representative or service center for information about the waste collection system in your country.



Attention in case of use

This transceiver works on frequencies which are not generally permitted.

As for the actual usage, the user has to possess an amateur radio license.

Usage is allowed only in the frequency bands which are allocated for amateur radios.

List of national codes					
AT	BE	BG	CY	CZ	DE
DK	ES	EE	FI	FR	GB
GR	HR	HU	IE	IT	LT
LU	LV	MT	NL	PL	PT
RO	SK	SI	SE	CH	IS
LI	NO	-	-	-	-

YAESU

Yaesu UK Ltd
Unit 12, Sun Valley Business Park
Winnall Close
Winchester SO23 0LB
United Kingdom
Tel: +44 (0)1962 866667
Fax: +44 (0)1962 856801
Email: sales@yaesu.co.uk

Declaration of Conformity

Nr. YUK-DOC-0601-16

We, Yaesu UK Ltd. certify and declare under our sole responsibility that the following equipment complies with the essential requirements of the Directive 1999/5/EC and 2011/65/EU.

Type of Equipment	HF/50MHz Transceiver
Brand Name	YAESU
Model Number	FT-891
Manufacturer	YAESU MUSEN CO. LTD.
Address of Manufacturer	Tennozu Parkside Building, 2-5-8 Higashi-Shinagawa, Shinagawa-ku, Tokyo, 140-0002 Japan

Applicable Standards:

This equipment is tested to and conforms to the essential requirements of directive, as included in following standards:

Health 1999/5/EC Art. 3 (1) (a)	EN 62311:2008
Safety 1999/5/EC Art. 3 (1) (a)	EN 60950-1:2006 + A2:2013
EMC 1999/5/EC Art. 3 (1) (b)	EN 301 489-01 V1.9.2
	EN 301 489-15 V1.2.1
Radio Spectrum 1999/5/EC Art. 3 (2)	EN 301 783-02 V1.2.1
ROHS2 2011/65/EU Art. 7 (b)	EN 50581:2012

The technical documentation as required by the Conformity Assessment procedures is kept at the following address:

Company
Address
Technical Construction file

Yaesu UK Ltd
Unit 12, Sun Valley Business Park, Winnall Close

Winchester, Hampshire UK SO23 0LB
Issued by: Yaesu Musen Co. Ltd, Tokyo Japan
File No: YETA00416
Drawn up in: Winchester, Hampshire UK
Date: 06-Jun 2016

Signed for and on behalf of Yaesu UK Ltd



Name and position: PCJ Bigwood
Technical Sales Manager

YAESU

The radio

Copyright 2016
YAESU MUSEN CO., LTD.
All rights reserved.
No portion of this manual may be
reproduced without the permission of
YAESU MUSEN CO., LTD.

YAESU MUSEN CO., LTD.
Tennozu Parkside Building
2-5-8 Higashi-Shinagawa, Shinagawa-ku, Tokyo 140-0002 Japan

YAESU USA
6125 Phyllis Drive, Cypress, CA 90630, U.S.A.

YAESU UK
Unit 12, Sun Valley Business Park, Winnall Close
Winchester, Hampshire, SO23 0LB, U.K.



1611A-BO-2
Printed in Japan

