



AR3000A

service manual

AOR, LTD. 2-6-4 MISUJI, TAITO-KU TOKYO 111, JAPAN

Downloaded by
RadioAmateur.EU



	PAGE
SPECIFICATIONS -----	(1)
BLOCK DIAGRAM -----	(2)
THEORY OF OPERATION:	
SIGNAL PATH CIRCUITS -----	(3)
FRONT BPF RF AMP UNIT -----	(4)
MAIN UNIT -----	(4)
PLL 2nd OSC UNIT -----	(5)
CPU-LCD UNIT -----	(5)
MAINTENANCE:	
TEST EQUIPMENT REQUIRED -----	(6)
ALIGNMENT AND CALIBRATION -----	(6)
FRONT BPF RF AMP UNIT -----	(6) - (13)
PLL 2nd OSC UNIT -----	(13)
MAIN UNIT -----	(14) - (17)
CHECK -----	(18)
LIST OF DATA:	
DC VOLTAGE -----	(19) - (20)
BIRDIE LIST -----	(21)
RESET & BAUD RATE CHANGE SWITCH -----	(22)
SEMI-CONDUCTORS -----	(23) - (27)
RF COILS -----	(28)
FRONT PANEL ASSEMBLY -----	(28)
PARTS LIST (MISCELLANEOUS) -----	(29)
ILLUSTRATIONS:	
EXPLODED VIEW -----	(30)
<u>UNIT BOARD PARTS LAYOUTS</u>	
FRONT BPF RF AMP UNIT -----	(31)
MAIN UNIT -----	(32)
PLL 2nd OSC UNIT -----	(33)
CPU-LCD UNIT -----	(34) - (35)
SCHEMATIC DIAGRAMS:	
FRONT BPF RF AMP UNIT -----	(36)
MAIN UNIT -----	(37)
PLL 2nd OSC UNIT -----	(38)
CPU-LCD UNIT -----	(39)

SPECIFICATIONS

Model : AR3000A
Receiver coverage : 100KHz - 2036MHz
Receiver mode : USB, LSB, CW, AM, NFM(narrow), WFM(wide)
Receiver circuitry : Triple(USB/LSB/CW/AM/NFM) & quadruple (WFM) conversion superheterodyne
Number of memory channel: 400 channels(4 banks of 100 channels)
Scan rate : 20 channels/second
Search rate : 20 steps/second
Receiver sensitivity :

RANGE	MODE	10dB S/N		12dB SINAD	
		SSB/CW	AM	NFM	WFM
100KHz-2.5MHz		1.0uV	3.2uV	-	-
2.5MHz-1.8GHz		.25uV	1.0uV	.35uV	1.0uV
1.8GHz-2.0GHz		.75uV	3.0uV	1.25uV	3.0uV

Receiver selectivity : 2.4KHz/-6dB, 4.5KHz/-60dB (USB/LSB/CW)
 12 KHz/-6dB, 25 KHz/-70dB (AM/NFM)
 180KHz/-6dB, 800KHz/-50dB (WFM)
Antenna connector : 50 ohm BNC
Audio output : 1.2 watts at 4 ohm load 10% distortion
 0.7 watts at 8 ohm load 10% distortion
Power requirement : 13.8 volts DC, approx. 500mA
Display : Liquid crystal display(with back-light function)
Dimensions : 138mm wide x 80mm high x 200mm long
Weight : 1.2 Kgs
Standard accessories : AC adaptor, DC cable, Rod antenna & Operator's manual

Optional accessories : Mobile mounting bracket - Model MM-1
 Discone type outdoor antenna with 15 meter coaxial cable with connectors - Model DA3000 (for receive range 25 - 2036MHz)
 Active outdoor antenna for 10KHz - 30MHz and passive whip for 30MHz - 2000MHz with 15 meter coaxial cable with connectors - Model WA7000 (for receive range 10KHz - 2036MHz)
 Indoor loop antenna - Model LA320 (for receive range 150KHz - 15MHz)

**Downloaded by
RadioAmateur.EU**

RR-3000A BLOCK DIAGRAM
 15886 (REV. 0) AL. 802 (2/7/81)

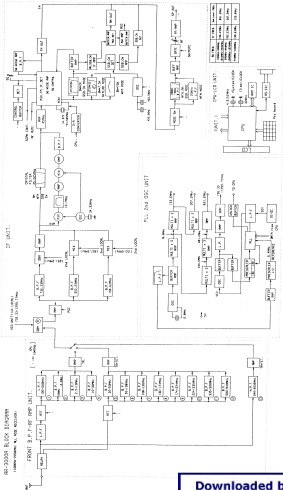

RR-3000A BLOCK DIAGRAM

RR-3000A

SIGNAL PATH CIRCUITS:

Refer to the block diagram of the AR 3000A. All signals from antenna connector are switched into two attenuators for below 30MHz or above 30MHz.

Succeeding 11 BPF(band pass filters) and one each LPF(low pass filter) and HPF(high pass filter) are prepared for 13 frequency ranges for pre-selection before RF amplifiers.

Three RF amplifiers are provided for frequency ranges for below 30MHz, 30 - 940MHz & 940 - 2036MHz.

In the MAIN UNIT, signal from RF amplifier enters into DBM (double balanced mixer), then mixed with local carrier frequency of 736.93 - 1299.77MHz to produce three kind IF frequencies as follow:

736.23MHz for 100KHz - 500MHz & 1650MHz - 2036MHz

352.23MHz for 500MHz - 940MHz 1300MHz - 1650MHz

198.63MHz for 940MHz - 1300MHz

Three BPF for each IF frequencies according to receiving frequency range are followed.

Post 736.23MHz BPF, signal is mixed with 2nd local carrier of fixed 691.2 MHz to produce 45.03MHz 2nd IF frequency, then amplified to compensate the loss in the 2nd DBM mixer.

Signals pass through two BPFs, 352.23MHz & 198.63MHz, are mixed with different fixed 2nd local carrier of 307.2MHz & 153.6MHz to produce same 45.03MHz 2nd IF frequency accordingly.

All mode except for WFM(wide) signal passes through crystal filter 45.0275MHz.

In case of WFM(wide), signal is mixed with crystal oscillator 34.33MHz to get 10.7MHz IF for suitable selectivity for WFM, then amplified and mixed again to recover 45.03MHz.

Amplified 45.03MHz signal enters into combination IC, for 3rd mixer, VCXO, FM IF amplifier, FM detector, squelch noise amplifier and squelch control. VCXO(voltage controlled crystal oscillator) oscillates 44.565 - 44.575MHz, varying 10KHz controlled by D-A (digital to analog) converter in wanted frequency steps by CPU.

Subtracted 455KHz signal passes through three kind of filters selected by its mode, then buffered and re-enters into combination IC for FM detection and squelch function. For AM/SSB/CW signals, separate AM IF amplifier is provided to follow AGC/AM detector and product detector for SSB/CW signals.

Crystal controlled BFO(beat frequency oscillator) injects stable carrier 453.5KHz or 456.5KHz according to its side band (LSB or USB).

Mode switch selects detector outputs for wanted mode, then audio signal passes through audio bandpass filter 300Hz - 3000Hz for WFM/AM/SSB or low pass filter 20KHz for WFM. Next audio signal is gated for squelch mute and followed into audio power amplifier to drive internal speaker.

FRONT BPF RF AMP UNIT

Mechanical relay selects two attenuators for below 30MHz/20dB or beyond 30MHz/10dB frequency ranges. For below 30MHz, three BPFs, one LPF and one RF amplifier are prepared by bipolar transistor 2SC3356. For beyond 30MHz, seven BPFs, one HPF and two RF amplifiers are prepared by combination of transistor 2SC3585/FET 2SK571. All necessary switchings are automatically controlled by CPU in CPU-LCD UNIT.

MAIN UNIT

Diode package HP-5082-2831 along with two transformers works as DBM(double balanced mixer) and the first mixer of the AR3000A. The first IF amplifier AGC controlled by transistor 2SC3585 is provided for all signals, and then three BPFs for different IF frequencies follow.

BPF for 736.23MHz is for the lowend and the highend receiving bands, and followed by similar DBM second mixer and the second IF amplifier which is AGC controlled by transistor 2SC2759.

BPF for 352.23MHz is for 500-940MHz and 1300-1650MHz receiving bands and followed by transistor second mixer by 2SC2759.

BPF for 198.63MHz is for 940-1300MHz receiving band and followed by transistor second mixer by 2SC2759, as well.

All injection carriers of four kinds are supplied by PLL 2nd OSC UNIT.

All signals are now converted to same 45.0275MHz, and it passes through crystal filter for all modes except WFM mode.

In WFM mode, 45.0275MHz signal is mixed with 34.33MHz crystal oscillator to make 10.7MHz IF frequency for the ceramic filter SPT10.7-MS2-A with proper bandwidth for WFM mode.

10.7MHz signal is mixed again with same 34.33MHz crystal oscillator to recover 45.0275MHz. For two mixers, diode package of ND487C1-3R along with RF transformers are used. Two stage of IF amplifiers, one for 10.7MHz and one for 45.0275MHz, are provided to compensate losses through filter and two passive mixers.

Filtered 45.0275MHz signal is amplified again in Q14 45.0275MHz amplifier by transistor 2SC2759, and then enters into IC-1 MC3357 combination chip for the third mixer, VCXO(voltage controlled crystal oscillator), FM IF amplifier, FM detector, squelch noise amplifier and squelch control.

VCXO oscillates 44.575-44.565MHz, varying 10KHz in required frequency steps(the finest 50Hz for SSB tuning) which is controlled by D-A converter under control of CPU.

Converted 455KHz signal passes through three kind IF filters selected by its mode, then buffered and re-enters into MC3357 IC for FM detection and squelch control.

Ceramic filter CFJ455K for SSB/CW 2.4KHz, CFZM455F for NFM/AM and RF tuned coil for WFM 70KHz are provided.

For AM/SSB/CW, separate IF amplifier is provided to follow AGC/AM detector and product detector for SSB/CW.

Stable crystal beat oscillator for 453.5/456.5KHz injects appropriate carrier according to required side band receiving.

MAINTENANCE

COVER REMOVAL

Remove the two screws near the rubber feet on the bottom of the AR3000A. Remove four screws of the back side of the case. Remove the lower case by pulling down and then lift upward the back wall of the upper case and pull backward to remove the upper case.

TEST EQUIPMENT REQUIRED

Following is a list of test equipments recommended for maintenance of this receiver.

1. DC power supply well regulated 12V 1Ampere capacity.
2. DC volt meter
3. AC volt meter
4. SINAD meter
5. Oscilloscope with 10MHz response
6. Frequency counter with 1300MHz response and -20dBm sensitivity
7. Signal Generator with range of 455kHz to 2300MHz preferable.
S.G. with 1000MHz range can be used for extra range as one half frequency generator calibrated with a spectrum analyzer.
8. Spectrum analyzer with 2300MHz response
9. Tracking generator with 2300MHz response
10. Distortion meter

ALIGNMENT AND CALIBRATION

It is not necessary to align a new receiver. Each receiver is carefully aligned and checked by our expert technicians before it is forwarded from the factory.

If it comes necessary to align any of the units in the AR3000A receiver, proceed as follows:

FRONT END BPF RF AMP ALIGNMENT

No alignment required for up to BAND #6(50-108MHz) as fixed value inductors & capacitors are included.

For more than BAND #7(108-136MHz), critical alignment can be made when specified equipments mentioned above are available. Never try to align or adjust inductors/capacitors without above mentioned equipments.

1. Bias adjustment required prior to BPF alignment.
Three potentiometers VR1, 2 & 3 are on the front end board. Adjust these potentiometers as follow:
VR1: Set receiving frequency of the receiver at any point in 30-940MHz range(BAND #5-12). Connect DC voltmeter at drain of Q19 2SK571 and adjust VR1 to get 3.6V DC.
VR2: Set receiving frequency of the receiver at any point in 940-2036MHz range(BAND #13). Connect DC voltmeter at drain of Q2 2SK571 and adjust VR2 to get 3.1V DC.
VR3: Set receiving frequency of the receiver at any point in 940-2036MHz range(BAND #13). Connect DC voltmeter at drain of Q3 2SK571 and adjust VR3 to get 3.1V DC.

For above adjustment, step frequency & mode of the receiver are not important.

2. For BAND #1 through BAND #6, no adjustment parts existed but if it is necessary to confirm passband characteristics, check it by spectrum analyzer and tracking generator as follow:

Connect output of tracking generator to antenna input of the AR3000A and input of spectrum analyzer to J-4(output terminal) of front BPF KF AMP board.

Characteristics of each band should be similar as follows:

BAND #1 (100-500KHz) L.P.F.

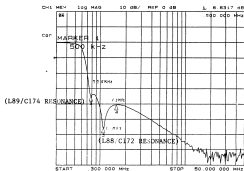

BAND #2 (500-2500KHz) B.P.F.

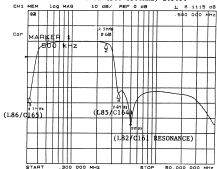

By three resonators L81/C160, L84/C163, L87/C166 confirm the most flat and high response of the Band Pass Filter.

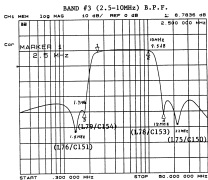

Downloaded by
RadioAmateur.EU

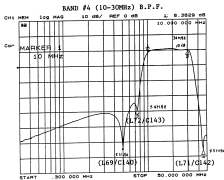

BAND #5 (30-50MHz) B.P.F.

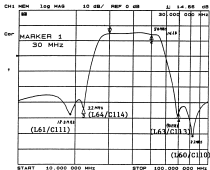

BAND #6 (50-108MHz) B.P.F.

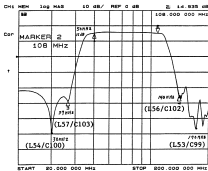

For BAND #7 through #13, following adjustments are proceeded if necessary.

BAND #7 (108-136MHz) B.P.F.

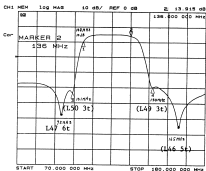

Adjust four coils L46,47,49 & 50 for 165, 95, 150 & 101MHz respectively. Then adjust coils L45, 48 & 51 for the most flat response.

BAND #8 (137-174MHz) B.P.F.

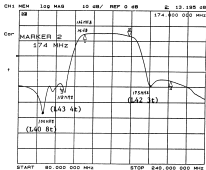

Adjust three coils L40, 42 & 43 for 100, 195 & 118MHz respectively. Then adjust L41 2t for the most flat response.

BAND #9 (174-224MHz) B.P.F.

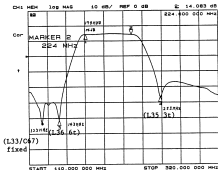

Adjust two coils L35 & 36 for 255 & 143MHz respectively.
Then adjust L34 2t for the most flat response.

BAND #10 (224-335MHz) B.P.F.

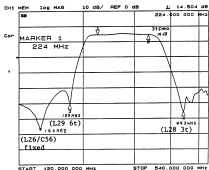

Adjust two coils L28 & 29 for 443 & 180MHz respectively.
No adjustment for pass band as L16, 19 & 22 are fixed value.

BAND #11 (335-500MHz) B.P.F.

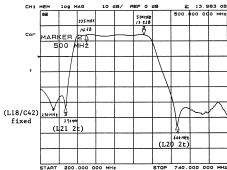

Adjust coils L20 & 21 for 600 & 270MHz respectively.
Then adjust L19 2t for the most flat response.

BAND #12 (500-940MHz) B.P.F.

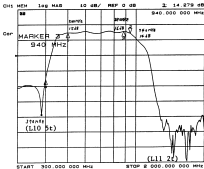

Adjust coils L10 for 370MHz resonance and L11 for less ripple around 880MHz. No evident change observed at upper resonant point around 1100MHz for L11 adjustment. L11 is mounted on the back of the printed board.

BAND #13 (940-2036MHz) H.P.F.

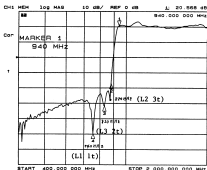

Adjust three coils L1, 2 & 3 for 740, 880 & 820MHz respectively. Then adjust L4 it for the most flta response.

PLL 2ND OSC UNIT ALIGNMENT

1. MASTER OSCILLATOR ADJUSTMENT (12.8MHz CRYSTAL OSCILLATOR)

Set the AR3000A as follow and connect the frequency counter at J10 of the MAIN UNIT.

STEP: 50Hz, MODE: AM/NFM/WFM, FREQUENCY: 2036.000MHz

Adjust TC-1 trimmer capacitor carefully to get precise frequency of 1299.78000MHz on the counter

Remove the frequency counter and check the RF level of +3dBm to +8dBm at J10 connector by the spectrum analyzer.

2. 153.600MHz INJECTION

Set the AR3000A as follow and connect the frequency counter and the spectrum analyzer at J4 of MAIN UNIT.

STEP: 50Hz, MODE: AM/NFM/WFM, FREQUENCY: 940.000 - 1299.99995MHz

Then adjust trimmer capacitors TC2,3,4,5,6 & 7 to get 153.600MHz and RF level of -3dBm to 0 dBm.

3. 307.200MHz INJECTION

Set the AR3000A as follow and connect the frequency counter and the spectrum analyzer at J5 of MAIN UNIT.

STEP: 50Hz, MODE: AM/NFM/WFM, FREQUENCY: 500.000 - 939.99995MHz

Then adjust trimmer capacitors TC8 & 9 to get 307.200MHz and RF level of -3dBm to 0 dBm.

4. 691.200MHz INJECTION

Set the AR3000A as follow and connect the frequency counter and the spectrum analyzer at J11 of MAIN UNIT.

STEP: 50Hz, MODE: AM/NFM/WFM, FREQUENCY: 0.1000 - 499.99995MHz

Then adjust trimmer capacitors TC10,11,12,13,14 & 15 to get 691.200MHz and RF level of -3dBm to 0dBm.

MAIN UNIT ALIGNMENT

1. VCKO ADJUSTMENT (44.575MHz)

- *Special made pick-up coil (airwound 7 turn 10mm diameter by 1.2mm^ø enamel coated copper wire soldered directly to BNC socket) and
- *Tuned amplifier (44.570MHz tuned three stage amplifier, gain 50dB) are required for this adjustment.



Set the pick-up coil near to L30 coil on the AR3000A board shown as above illustration. Loose coupling to avoid frequency change is required. Connect coaxial cable with BNC plugs to the pick-up coil and other end of the cable to input of tuned amplifier. Connect frequency counter to output of 50dB gain tuned amplifier.

Set the AR3000A at 939.99200MHz, STEP ADJ 6kHz, AM or NFM or WFM, adjust L30 slug core for 44.5730MHz +200Hz -0Hz on the counter.

Change the frequency to 939.99800MHz, adjust Vr1 potentiometer near L30 for 44.5670MHz +200Hz -0Hz.

Above two processes interact each other and repeat several times until no more improvement is obtained.

2. SSB CRYSTAL ADJUSTMENT (453.50/456.50kHz)

- Special pick-up coil and tuned 50dB gain amplifier are required for this adjustment. Pick-up coil as same as above except cold end is open not soldered to ground side of BNC connector.
- Tuned two stage amplifier of total gain of approx. 50dB.

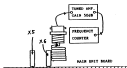

Set the pick-up coil with coaxial cable near to X6 crystal unit shown as above illustration. (same position for two trimmer caps.)

Set the AR3000A at any of 0.1000-939.99995MHz, STEP 50Hz, MODE LSB, adjust TC9 trimmer capacitor to get 453.50kHz+200Hz-0Hz.
MODE USB, adjust TC10 = " " 456.50kHz+200Hz-0Hz.

3. MCF (MONOLITHIC CRYSTAL FILTER) ADJUSTMENT

Set the receiver STEP for 50Hz, MODE for AM or NFM, FREQUENCY 0.1000 - 499.9995MHz. Connect output of the tracking generator through 1000PF capacitor to base of Q2 28C2759 and the spectrum analyzer at pin #16 of ICI MC3357 through 1000PF capacitor. Adjust ferrite cores of transformers L7, 19 & 20 to get flat and highest response as shown below.

Output level of the tracking generator: -50dBm

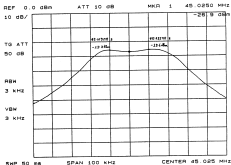

Change receiving frequency to 500.000 - 999.9995MHz and output of the tracking generator to emitter of Q4 28C2759 through 1000PF capacitor.

Adjust ferrite core of transformer L14 to get flat and highest response as shown below.

Output level of the tracking generator: -30dBm

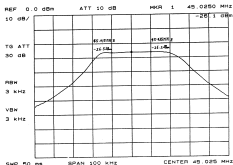

Change receiving frequency to 940.000 - 1299.99995MHz and output of the tracking generator to emitter of Q6 2SC2759 through 1000PF capacitor.

Adjust ferrite core of transformer L18 to get flat and highest response as shown below.

Output level of the tracking generator: -30dBm

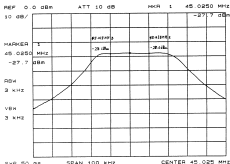

4. HELICAL RESONATORS & INJECTION LEVEL ALIGNMENT

Set the receiver, STEP: 50Hz, MODE: AM, FREQUENCY: 128.90000MHz and connect the signal generator output to antenna jack of the receiver. Connect 8 ohm 2 watts non-inductive resistor as an external load to external speaker jack and paralleled with oscilloscope, AC voltmeter & SINAD meter.

Also connect DC voltmeter at pin #10 of J9 connector of the main unit board for AGC voltage.

Set the VR5 potentiometer at fully clockwise position in this stage.

Set SG frequency 128.90000MHz and modulation AM 60% and output level to indicate 3.0 V DC at pin #10 of J9 (AGC) on the DC voltmeter.

Set SG output off then adjust VR3 potentiometer to get 4.8 V on the DC voltmeter.

Then set SG output on and adjust helical resonator L1 (three metal screws), RF transformers L29 & 31 for minimum indication on DC voltmeter. Check 10dB signal to noise ratio is obtainable at less than +6dBu EMF input for the receiver.

In same setting as above except frequency change of receiver/SG to 880.90000MHz, adjust helical resonator L10 (three metal screws) and trimmer capacitor TC7 for minimum indication on DC voltmeter. Check 10dB signal to noise ratio is obtainable at less than +6dBu EMF input for the receiver.

Remain same setting as above adjustment except frequency change to 940.90000MHz, then adjust the helical resonator L15 (three metal screws) and trimmer capacitor TC8 for minimum indication on DC voltmeter.

Check if 10dB signal to noise ratio is obtainable at less than +5dBu EMF input for the receiver.

Change frequency of the receiver/SG to 0.24300MHz and set SG output level for 0 - +7dBu EMF.

Adjust trimmer capacitor TC6 for minimum deflection of the SINAD meter.

Check if 10dB signal to noise ratio is obtainable at less than +12dBu EMF input for the receiver.

5. 455KHz ADJUSTMENT

Remain same setting as above 4. alignment, change MODE to WFM and frequency to 128.90000MHz, SG modulation FM 50KHz deviation and output level for 50dBu EMF.

Adjust transformer L28 to get symmetric and largest wave form on the oscilloscope screen.

Check if 12dB SINAD is obtainable at less than +6dBu EMF input for the receiver.

Change MODE to NFM and frequency to 780.90000MHz, SG modulation FM with 3.5KHz deviation and output level for -3dBu EMF.

Adjust transformer L29 for minimum deflection on SINAD meter.

Check if 12dB SINAD is obtainable at less than -3dBu EMF input for the receiver.

6. S METER ADJUSTMENT

Set the receiver at 128.90000MHz, AM mode, 50Hz step and connect SG output to antenna jack of the receiver same frequency, 0dBu EMF, no modulation.

Adjust potentiometer VR5 (fully clockwise positioned in early stage of adjustment) for two dots indication on the LCD display.

Change frequency to 880.90000MHz and check if two dots S indication occurs with -3 to +6dBu EMF input for the receiver.

Change frequency to 940.90000MHz and check if two dots S indication occurs with -3 to +6dBu EMF input for the receiver.

Set the receiver at 128.90000MHz, WFM mode, 50Hz step and connect SG output to antenna jack of the receiver same frequency, +3dBu EMF level, no modulation.

Adjust potentiometer VR4 for two dots indication on the LCD "S" display.

CHECK

1. SENSITIVITY

Set the receiver 1299.90000MHz, NFM mode, 30Hz step and connect SG setting with same frequency, -3dBu EMF output, FM modulation 3.5KHz deviation to antenna jack. Connect SINAD meter to the external speaker jack of the receiver paralleled with 8 ohm non-inductive resistor as a dummy load. Check if more than 12dB SINAD is obtained.

Change frequency of the receiver and SG to 1999.90000MHz, SG output level to +6dBu EMF. Check if more than 12dB SINAD is obtained.

2. DISTORTION ON SSB/CW

Set the receiver 29.39000MHz, LSB mode, 50Hz step and connect SG setting 29.38850MHz, no modulation, 50dBu EMF output level to antenna jack. Connect distortion meter to the external speaker jack of the receiver paralleled with 8 ohm non-inductive resistor and the frequency counter for audio range. Check if audio output tone of the receiver is within 500-2500Hz and in less than 30% distortion.

Change receiving mode to USB and SG frequency to 29.39150MHz. Check if the output beat tone of the receiver within 500-2500Hz and in less than 30% distortion.

Change receiving mode to CW and SG frequency to 29.39000MHz. Check if the output beat tone is within 400-1500Hz and in less than 30% distortion.

Downloaded by
RadioAmateur.EU

AR3000A FRONT UNIT DC VOLTAGE

PART NO.	BASE	COLLECTOR	EMITTER	REMARKS
Q40 DTC124TK	4.4 (V)	0.0 (V)	GND	100KHz-30MHz
Q40 DTC124TK	3.6	0.0	GND	940MHz-2036MHz
Q40 DTC124TK	0.0	9.1	GND	30MHz-940MHz
Q41 DTB123YK	0.0	9.0	9.0	100KHz-30MHz
				940MHz-2036MHz
				30MHz-940MHz
Q41 DTB123YK	9.1	0.0	9.0	ATT ON
Q5 DTC124TK	4.9	0.0	GND	ATT OFF
Q5 DTC124TK	0.0	8.9	GND	ATT ON
Q6 DTC124TK	0.0	8.9	GND	ATT OFF
Q6 DTC124TK	8.9	0.0	GND	ATT ON
Q7 DTC124TK	4.9	0.0	GND	ATT OFF
Q7 DTC124TK	0.0	4.6	GND	ATT ON
Q8 DTC124TK	0.0	8.9	GND	ATT OFF
Q8 DTC124TK	4.6	0.0	GND	ATT ON
Q9 DTB123YK	8.9	0.0	8.9	ATT OFF
Q9 DTB123YK	0.0	8.8	8.9	ATT ON
Q24 DTC124TK	4.8	0.1	GND	100-500KHz ON
Q24 DTC124TK	0.0	8.4	GND	100-500KHz OFF
Q23 DTC124TK	4.8	0.0	GND	500KHz-2.5MHz ON
Q23 DTC124TK	0.0	8.4	GND	500KHz-2.5MHz OFF
Q22 DTC124TK	4.8	0.0	GND	2.5-10MHz ON
Q22 DTC124TK	0.0	8.4	GND	2.5-10MHz OFF
Q21 DTC124TK	4.8	0.0	GND	10-30MHz ON
Q21 DTC124TK	0.0	8.4	GND	10-30MHz OFF
Q17 DTC124TK	4.9	0.1	GND	30-50MHz ON
Q17 DTC124TK	0.0	8.4	GND	30-50MHz OFF
Q16 DTC124TK	4.9	0.1	GND	50-108MHz ON
Q16 DTC124TK	0.0	8.5	GND	50-108MHz OFF
Q15 DTC124TK	4.9	0.1	GND	108-136MHz ON
Q15 DTC124TK	0.0	8.5	GND	108-136MHz OFF
Q14 DTC124TK	4.9	0.1	GND	136-174MHz ON
Q14 DTC124TK	0.0	8.5	GND	136-174MHz OFF
Q13 DTC124TK	4.9	0.1	GND	174-224MHz ON
Q13 DTC124TK	0.0	8.5	GND	174-224MHz OFF
Q12 DTC124TK	4.9	0.1	GND	224-335MHz ON
Q12 DTC124TK	0.0	8.5	GND	224-335MHz OFF
Q11 DTC124TK	4.9	0.1	GND	335-500MHz ON
Q11 DTC124TK	0.0	8.5	GND	335-500MHz OFF
Q10 DTC124TK	4.9	0.1	GND	500-940MHz ON
Q10 DTC124TK	0.0	8.5	GND	500-940MHz OFF
Q1 28C3585	0.8	3.2	GND	940-2036MHz ON
Q2 28K571	-(G)	3.1 (D)	GND (S)	940-2036MHz ON
Q3 28K571	-(G)	3.1 (D)	GND (S)	940-2036MHz ON
Q4 DTC124TK	4.1	0.0	GND	940-2036MHz OFF
Q4 DTC124TK	0.0	8.5	GND	100KHz-30MHz ON
Q25 28C3356	0.8	3.6	GND	100KHz-30MHz ON
Q26 DTC124TK	4.2	0.0	GND	100KHz-30MHz ON
Q26 DTC124TK	0.0	8.4	GND	100KHz-30MHz OFF
Q18 28C3585	0.8	3.2	GND	30-940MHz ON
Q19 28K571	-(G)	3.6 (D)	GND (S)	30-940MHz ON
Q20 DTC124TK	4.2	0.0	GND	30-940MHz OFF
Q20 DTC124TK	0.0	8.5	GND	30-940MHz ON
Q35 DTC124TK	0.0	2.8	GND	30-940MHz OFF
Q35 DTC124TK	2.9	0.0	GND	30-940MHz OFF
Q36 DTC124TK	2.8	0.0	GND	30-940MHz ON

PART NO.	BASE	COLLECTOR	EMITTER	REMARKS	
Q36	DTC124TK	0.0	5.0	GND	30-940MHz OFF
Q37	DTB123YK	0.0	5.0	5.0	30-940MHz ON
Q37	DTB123YK	5.0	0.0	5.0	30-940MHz OFF
Q33	DTC124TK	4.3	0.0	GND	940-2036MHz ON
Q33	DTC124TK	0.0	5.0	GND	940-2036MHz OFF
Q34	DTB123YK	0.0	5.0	5.0	940-2036MHz ON
Q34	DTB123YK	5.0	0.0	5.0	940-2036MHz OFF
Q38	DTC124TK	4.2	0.0	GND	100KHz-30MHz ON
Q38	DTC124TK	0.2	5.0	GND	100KHz-30MHz OFF
Q39	DTB123YK	0.0	5.0	5.0	100KHz-30MHz ON
Q39	DTB123YK	5.0	0.0	5.0	100KHz-30MHz OFF
Q31	DTC124TK	4.9	0.0	GND	100KHz-500MHz ON
Q31	DTC124TK	0.0	5.0	GND	100KHz-500MHz OFF
Q32	DTB123YK	0.0	4.9	5.0	100KHz-500MHz ON
Q32	DTB123YK	5.0	0.0	5.0	100KHz-500MHz OFF
Q29	DTC124TK	4.9	0.0	GND	500-940MHz ON
Q29	DTC124TK	0.0	5.0	GND	500-940MHz OFF
Q30	DTB123YK	0.0	4.9	5.0	500-940MHz ON
Q30	DTB123YK	5.0	0.0	5.0	500-940MHz OFF
Q27	DTC124TK	4.9	0.0	GND	940-2036MHz ON
Q27	DTC124TK	0.0	5.0	GND	940-2036MHz OFF
Q28	DTB123YK	0.0	4.9	5.0	940-2036MHz ON
Q28	DTB123YK	5.0	0.0	5.0	940-2036MHz OFF

AR3000A FRONT UNIT DC VOLTAGE

PART NO.	ANODE 4.8 (V)	CATHODE 4.1 (V)	REMARKS
D37 18S269	4.8	4.1	K-C170 100-500KHz
D37 18S269	4.8	4.1	K-C148 2.5-10MHz
D39 18S269	4.8	4.1	K-C176 100-500KHz
D39 18S269	4.8	4.1	K-C167 500KHz-2.5MHz
D38 18S269	4.8	4.1	500KHz-2.5MHz
D35 18S269	4.8	4.1	10-30MHz
D36 18S269	4.8	4.1	K-C156 2.5-10MHz
D36 18S269	4.8	4.1	K-C145 10-30MHz
D34 18V196	4.8	4.1	ATT OFF 100KHz-30MHz 940-2036MHz
D32 18V196	2.4	1.8	ATT ON 100KHz-30MHz 940-2036MHz
D33 18V196	1.8	1.3	ATT ON 100KHz-30MHz 940-2036MHz
D45 182837	4.8	4.2	A-Q24 100-500KHz
D45 182837	4.8	4.2	A-Q21 10-30MHz
D46 182837	4.8	4.2	A-Q23 500KHz-2.5MHz
D46 182837	4.8	4.2	A-Q22 2.5-10MHz
D28 18S269	3.7	2.9	30-50MHz
D29 18S269	4.1	3.3	30-50MHz
D26 18S269	3.7	2.9	50-108MHz
D27 18S269	4.1	3.3	50-108MHz
D22 18S269	3.7	2.9	K-C86 108-136MHz
D22 18S269	3.7	2.9	K-C64 174-224MHz
D25 18S269	4.1	3.3	K-C94 108-136MHz
D25 18S269	4.1	3.3	K-C83 136-174MHz
D24 18S269	3.7	2.9	136-174MHz
D23 18S269	4.1	3.3	174-224MHz
D16 18S268	4.5	3.7	224-335MHz
D17 18S269	3.7	2.9	224-335MHz
D19 18S268	4.9	4.1	224-335MHz
D18 18S269	4.1	3.3	224-335MHz
D12 18S268	4.5	3.7	335-500MHz
D13 18S269	3.7	2.9	335-500MHz
D15 18S268	4.9	4.1	335-500MHz
D14 18S269	4.1	3.3	335-500MHz
D5 18S268	5.3	4.5	500-940MHz
D6 18S269	4.5	3.7	500-940MHz
D8 18S268	5.3	4.5	500-940MHz
D7 18S269	4.5	3.7	500-940MHz
D4 18V196	4.8	4.1	ATT OFF 30-940MHz
D2 18V196	2.6	1.9	ATT ON 30-940MHz
D3 18V196	1.9	1.3	ATT ON 30-940MHz
D9 18S268	6.1	5.4	30-500MHz
D9 18S268	5.3	4.7	500-940MHz
D9 18S268	8.9	8.2	100KHz-30MHz 940-2036MHz
D10 18S269	5.4	4.5	30-500MHz
D10 18S269	4.7	4.1	500-940MHz
D10 18S269	8.2	7.7	100KHz-30MHz 940-2036MHz
D20 18S268	4.5	3.7	30-500MHz
D20 18S268	4.1	7.3	500-940MHz
D20 18S268	7.7	7.3	100KHz-30MHz 940-2036MHz
D11 18S268	5.6	4.8	30-500MHz
D11 18S268	5.2	8.0	500-940MHz
D11 18S268	8.9	8.2	100KHz-30MHz 940-2036MHz
D21 18S268	4.8	7.2	30-500MHz
D21 18S268	8.0	7.4	500-940MHz
D21 18S268	8.2	7.4	100KHz-30MHz 940-2036MHz
D41 18V196	4.8	4.1 (8.4)	100KHz-30MHz (OFF)

PART NO.	ANODE	CATHODE	REMARKS	
D31 1SV196	4.8	4.1 (8.5)		30-940MHz (OFF)
D1 1SV196	4.8	4.1 (8.5)		940-2036MHz (OFF)
D47 1S2837	4.2	2.9	A-Q38	100KHz-30MHz
D47 1S2837	4.3	2.9	A-Q33	940-2036MHz
D50 1S2837	5.0	4.2		30-940MHz
D49 1S2837	5.0	4.2		940-2036MHz
D51 1S2837	5.0	4.2	A-Q34	940-2036MHz
D51 1S2837	5.0	4.2	A-Q39	100KHz-30MHz
D44 1S2837	4.2	3.6	A-050	30-940MHz
D44 1S2837	4.2	3.6	A-D49	940-2036MHz

AR3000A PLL UNIT DC VOLTAGE

PART NO.	BASE	COLLECTOR	EMITTER	REMARKS
Q8 28C1009A	2.34 (V)	4.96 (V)	1.88 (V)	
Q9 28C1009A	0.73	2.70	GND	
Q10 28C3356	0.41	3.41	GND	
Q11 28C3585	0.52	3.62	GND	
Q12 28C3585	0.35	4.10	GND	
Q13 28C3585	0.47	2.66	GND	
Q14 28C3585	0.67	3.46	GND	
Q15 28C3585	0.79	2.75	GND	
Q1 28C3585	0.80	3.88	GND	
Q2 28C3585	0.80	3.90	GND	
Q3 28C3585	0.80	3.14	GND	
Q4 28A812	4.88	0.00	5.00	WHEN PLL LOCKED
Q4 28A812	4.40	4.96	5.00	WHEN PLL UNLOCKED
Q5 28C1623	0.00	3.23	GND	WHEN PLL LOCKED
Q5 28C1623	0.61	0.02	GND	WHEN PLL UNLOCKED
Q6 28C1009A	0.60	1.63	GND	
Q7 28C1623	5.90	6.12	5.22	

Downloaded by
 RadioAmateur.EU

AR3000A MAIN UNIT DC VOLTAGE

PART NO.	BASE	COLLECTOR	EMITTER	REMARKS
Q17 2SC3585	0.80 (V)	2.87 (V)	GND (V)	
Q2 2SC2759	0.74	2.27	GND	
Q4 2SC2759	0.72	2.45	GND	
Q6 2SC2759	1.59	2.97	0.92	
Q11 2SC2759	0.73	2.71	GND	WFM
Q10 2SC1009A	2.08	4.37	1.37	WFM
Q12 2SC2759	0.74	2.28	GND	WFM
Q7 DTA123YK	4.71	0.00	5.02	WFM
Q7 DTA123YK	0.45	5.01	5.02	OTHER THAN WFM
Q8 DTC144TK	4.71	0.04	GND	WFM
Q8 DTC144TK	0.45	5.00	GND	OTHER THAN WFM
Q9 DTA123YK	0.04	4.98	5.02	WFM
Q9 DTA123YK	5.00	0.04	5.02	OTHER THAN WFM
Q14 2SC2759	0.72	4.73	GND	
Q23 2SC1009A	1.33	1.82	0.63	
Q24 2SC1009A	3.15	2.46	3.65	
Q25 2SC1009A	2.81	3.56	2.17	LSB USB CW
Q25 2SC1009A	2.82	3.57	2.15	OTHER THAN SSB
Q18 2SC1009A	3.80	5.02	3.17	
Q21 2SC1623	0.75	0.98	0.18	
Q20 DTC124TK	0.21	5.47	0.00	AM
Q20 DTC124TK	0.51	4.68	0.07	AM 128.9MHz TO J1 +20dBuVEMF 60%
Q20 DTC124TK	0.72	3.16	0.21	AM 128.9MHz TO J1
Q19 DTC124TK	5.43	5.03	4.87	AM
Q19 DTC124TK	4.66	5.03	4.08	AM 128.9MHz TO J1 +20dBuVEMF 60%
Q19 DTC124TK	3.15	5.02	2.57	AM 128.9MHz TO J1 +40dBuVEMF 60%
Q44 DTC124TK	4.19	0.00	GND	LSB
Q44 DTC124TK	3.71	0.00	GND	USB CW
Q36 2SC1623	1.59	1.90	1.03	NFM AM
Q36 2SC1623	0.60	0.95	0.01	WFM LSB USB CW
Q35 DTC144TK	4.26	0.01	GND	WFM
Q35 DTC144TK	3.74	0.01	GND	LSB
Q35 DTC144TK	3.27	0.01	GND	USB CW
Q15 DTC144TK	4.71	0.00	GND	WFM
Q31 DTC124TK	3.95	0.01	GND	POWER SW ON
Q31 DTC124TK	0.00	5.46	GND	POWER SW OFF
Q34 DTC124TK	3.43	0.00	GND	WHEN PLL LOCK
Q34 DTC124TK	0.03	1.02	GND	WHEN PLL UNLOCK
Q40 DTC144TK	3.51	0.00	GND	WHEN SQ OFF
Q40 DTC144TK	0.00	OFF	GND	WHEN SQ ON
Q41 DTB123YK	0.00	ON	RECORDING	
Q41 DTB123YK	EMITTER	OFF	RECORDING	WHEN SQ OFF
Q32 2SC1623	0.13	OFF	TERMINAL (V)	WHEN SQ ON
Q32 2SC1623	0.61	ON	RECORDING	WHEN SQ OFF
Q30 DTC124TK	0.00	2.84	GND	WHEN SQ ON
Q30 DTC124TK	4.95	0.00	GND	NORMAL MODE
Q29 DTC124TK	2.84	ON	GND	WHEN ALARM ON
Q29 DTC124TK	0.00	OFF	GND	NORMAL MODE
Q33 2SC1623	3.73	4.34	3.21	WHEN ALARM OFF
Q43 DTC124TK	3.46	0.00	GND	NFM
Q43 DTC124TK	0.10	5.03	GND	WHEN SQ ON
				WHEN SQ OFF
IC12 88054HN	PIN-NO	H-L	(V)	REMARK
	1	H	4.62	POWER SOURCE (V)
	1	L	0.10	POWER SOURCE (V)
				OVER 8V UNDER 8V

AR3000A MAIN UNIT DC VOLTAGE

PART NO.	ANODE	CATHODE	REMARKS
D4 18S268	2.86 (V)	2.13 (V)	100KHz-499.99995MHz
D5 18S268	2.84	2.13	1650MHz-2036MHz
D5 18S268	2.84	2.13	500MHz-939.99995MHz ANODE L14
D5 18S268	2.84	2.13	1300MHz-1649.99995MHz
D6 18S268	3.64	2.94	940MHz-1299.99995MHz ANODE L18
D6 18S268	3.43	2.73	OTHER THAN WFM ANODE R27
D7 18S268	3.64	2.94	WFM ANODE R29
D7 18S268	3.43	2.74	OTHER THAN WFM ANODE L20
D15 18S268	3.17	2.48	WFM ANODE R30
D15 18S268	2.44	1.76	NFM AM ANODE R89
D15 18S268	2.20	1.53	LSB ANODE R91
D17 18S268	3.42	2.70	USB CW ANODE R91
D17 18S268	2.94	2.23	NFM AM ANODE R90
D17 18S268	2.64	1.93	LSB ANODE R92
D28 18S269	1.79	1.12	USB CW ANODE R92
D28 18S269	1.79	1.11	WFM CATHODE R206
D16 18S269	1.76	1.11	WFM CATHODE R173
D16 18S269	1.76	1.06	WFM CATHODE R173
D21 18S268	0.32	GND	LSB 100KHz CATHODE R93
D21 18S268	0.33	GND	USB CW -939.99995MHz ANODE R106
D21 18S268	0.33	GND	USB CW 940MHz-2036MHz ANODE R106
D21 18S268	0.33	GND	USB CW 100KHz ANODE R107
D21 18S268	0.35	GND	-939.99995MHz ANODE R107
D20 182837	4.72	4.19	LSB 940MHz-2036MHz ANODE R107
D20 182837	4.24	3.72	LSB
D22 182837	4.79	4.25	USB CW ANODE D22
D22 182837	4.78	4.24	USB
D19 182837	4.85	4.31	CW
D19 182837	4.85	4.31	NFM
D10 18S268	3.62	2.93	AM
D10 18S268	4.71	4.00	NFM AM ANODE R81
D10 18S268	3.51	2.82	WFM ANODE R80
D10 18S268	3.08	2.39	LSB ANODE R81
D29 182837	4.31	3.83	USB CW ANODE R81
D29 182837	4.19	3.71	NFM AM ANODE D19
D29 182837	3.72	3.25	LSB ANODE D20
D14 182837	4.71	4.26	USB CW ANODE D20
D14 182837	4.19	3.74	WFM ANODE D20
D14 182837	3.72	3.28	LSB ANODE D20
D12 ND411	0.29	0.24	USB CW ANODE R65
D12 ND411	0.24	0.19	CATHODE C88 ANODE R66
D11 182837	0.83	1.42	NFM AM SQ-VR MIN
D11 182837	0.53	1.04	NFM AM SQ-VR THRESHOLD
D11 182837	-0.09	0.38	NFM AM SQ-VR MAX
D11 182837	0.90	1.37	WFM SQ-VR MIN
D11 182837	0.55	0.90	WFM SQ-VR THRESHOLD
D11 182837	0.55	0.38	WFM SQ-VR MAX
D11 182837	0.73	1.48	SSB SQ-VR MIN
D11 182837	0.60	0.30	SSB SQ-VR THRESHOLD
D11 182837	-0.28	0.40	SSB SQ-VR MAX
D23 182837	4.79	4.37	USB
D23 182837	4.79	4.37	CW
D24 182837	4.72	4.31	LSB
D26 182837	0.00	0.00	WHEN PLL LOCK ANODE R184

PART NO.	ANODE	CATHODE	REMARKS	
D26 1S2837	1.02	0.57	WHEN PLL UNLOCK	ANODE R184
D26 1S2837	0.00	0.00	WHEN SQ-OFF	ANODE R202
D26 1S2837	0.00	0.62	WHEN SQ-ON	ANODE R202
D36 1S2837	3.96	1.51	WHEN SQ-OFF	ANODE MC3357-14
D36 1S2837	0.00	0.00	WHEN SQ-ON	ANODE MC3357-14

IC-1 MC3357	PIN-NO	VOLTAGE	REMARKS
	1	4.38	
	2	3.75	
	3	4.47	
	4	4.62	
	5	0.94	
	6	0.96	
	7	1.01	
	8	4.60	
	9	1.79	
	10	1.90	
	11	1.94	
	12		SQ-VR FULL CLOCKWISE POSITION
	13		OPEN
	14		3.96(SQ-OFF) 0.00(SQ-ON)
	15	GND	
	16	1.95	

BIRDIE LIST

Every complex receiver has frequencies that are difficult or impossible to receive because of internally generated signals. These frequencies are called "BIRDIES". The following is a partial list of such frequencies that may occur in the AR3000. (Noted at 12' oclock squelch control position)

1.59MHz	677.94MHz	1305.60MHz
3.18	686.78	1316.57
12.58	691.20	1318.84
16.78	696.26	1321.18
20.97	696.27	1373.13
76.80	696.28	1382.40
89.60	754.74	1395.20
96.00	768.00	1404.91
102.40	831.54	1408.00
108.80	921.60	1420.80
115.20	989.13	1433.60
123.58	1011.64	1446.40
140.34	1020.91	1449.93
153.60	1065.93	1459.20
170.36	1075.20	1472.00
200.38	1097.71	1472.44
230.40	1142.73	1497.60
370.74	1152.44	1523.20
400.76	1162.97	1536.00
430.78	1165.24	1558.51
460.80	1165.69	1603.53
524.34	1165.70	1626.04
533.18	1167.58	1689.60
537.60	1174.51	1702.84
554.36	1216.00	1750.51
584.38	1219.53	1766.40
601.14	1228.35	1779.64
612.13	1228.80	1795.53
614.40	1251.31	1843.20
656.76	1296.33	1933.24

In addition, there are other frequencies that are difficult to receive because of interference from externally generated signals, such as T.V. stations, other receivers nearby and various other sources of man-made noise.

These frequencies vary from location to location and are therefore impossible to list.

When this type of interference is encountered, it can sometimes be eliminated by moving the squelch control knob counterclockwise (increase squelch action).

RESET & BAUD RATE CHANGE SWITCHES

(CPU/LCD UNIT BOARD CPU SIDE)

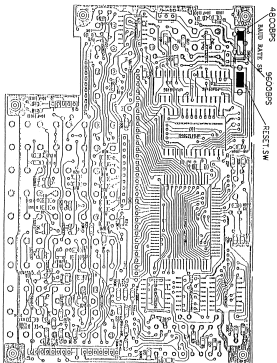

Downloaded by
RadioAmateur.EU

SEMI CONDUCTORS* DIODES

1S2837 SWITCHING
 1S8123 "
 1S8268 "
 1S8269 "
 1S8272 "
 1S1588 "
 RB100A RECTIFIER
 1SV196 PIN DIODE
 1SV163 VARI CAP.
 1SV166 "
 FC52M "
 ND411G-1 PAIR
 ND487C1-3R QUAD
 5082 2831 RING

* TRANSISTORS

2SA812
 2SC1009A
 2SC1623
 2SC2759
 2SC3356
 2SC3585
 2SK571 GaAs MOS FET
 DTA123YK
 DTB123YK
 DTC124TK
 DTC144TK
 DTC323TK

* INTEGRATED CIRCUITS

uA78L62 VOLTAGE REGULATOR
 uPC78M05H "
 S-8054HN VOLTAGE DETECTOR
 S-81250HG VOLTAGE REGULATOR
 L780809 " WITH STROBE
 ICL7660 CMOS VOLTAGE CONVERTER
 TL499A SWITCHING REGULATOR
 uPC1251G DUAL OPERATIONAL AMPLIFIER
 uPD4066BG QUAD BILATERAL SWITCH
 uPD4094BG 8 STAGE SHIFT STORE BUS REGISTER
 uPD4528BG DUAL MONOSTABLE MULTIVIBRATOR
 uPD74HC151G 8 INPUT DATA SELECTOR/MULTIPLEXER
 uPD74HC42AF BCD TO DECIMAL DECODER
 uPD43256AGU STATIC CMOS RAM
 uPD75316GF 1 CHIP 4 BIT MICRO COMPUTER
 TC74H107AF DUAL JK FLIP FLOP WITH CLEAR
 MB501L 2 MODULUS HIGH SPEED PRESCALER
 MC3357 LOW POWER FM IF
 MC145156 SERIAL INPUT PLL FREQUENCY SYNTHESIZER
 TC5090AP 8 BIT A/D CONVERTER
 uPC2002 AF POWER AMPLIFIER
 MAX232 RS-232 DRIVER/RECEIVER

ND487C1-3R
 (SCHOTTKY BARRIER
 DIODE QUAD)

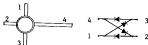



1S2837
1S5268
(SWITCHING)



1S5269
(SWITCHING)



1S5123
(HIGH SPEED SWITCHING)
ND411C-1
(SCHOTTKY BARRIER PAIR)



1S5272
(ULTRA HIGH SPEED SW)



bottom view

MC52M
(VARACTOR)



1SV163
1SV166
(VARACTOR)
1SV196
(PIN DIODE)



S-81250HC
(VOLTAGE REGULATOR)



S-8054HN
(VOLTAGE DETECTOR)



2SA812 DTA123YK
2SC1009A DTB123YK
2SC1623 DTC124TK
2SC2759 DTC144TK
2SC3356
2SC3585
(TRANSISTORS)



bottom view

uA78L62
(VOLTAGE REGULATOR)



2SK680
(N CHANNEL POWER MOS FET)



2SK571
(GaAs MES FET)



5082 2831
(SCHOTTKY BARRIER DIODE RING)



μPC78M05H
(VOLTAGE REGULATOR)

Downloaded by
RadioAmateur.EU

ICL7660
(CMOS VOLTAGE CONVERTER)



TC74H107AF
(DUAL J-K FLIP-FLOP WITH CLEAR)



TL499
(SWITCHING REGULATOR)



L780509
(VOLTAGE REGULATOR WITH STROBE)



1. Vin
2. NC
3. Gnd
4. STB
5. Vout

uPC1251
(DUAL OP AMPLIFIER)



MB501L
(2 MODULUS HIGH SPEED PRESCALER)

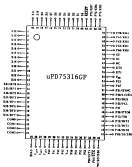

uPD75316GP
(1 CHIP 4 BIT MICRO COMPUTER)

MC3357
(LOW POWER FM IF)



- | | |
|-------------------------|---|
| PM-00 : Part 0 | SA-01 : Signal Output 0-21 |
| PM-01 : Part 1 | GM00-03 : Common Output 0-3 |
| PM-02 : Part 2 | VCC-0 : LCD Power Supply 0-2 |
| PM-03 : Part 3 | WR00 : LCD Power Supply Bias Control |
| PM-04 : Part 4 | LDCKL : LCD Clock |
| PM-05 : Part 5 | STYMC : LCD Synchronization |
| PM-06 : Part 6 | TR0 : Timer Input 0 |
| PM-07 : Part 7 | OTD0 : Programmable Timer Output 0 |
| SP-0 : Bias Point | RE0 : Reset Clock |
| SD-0 : Bias Point | PCL : Programmable Clock |
| SCR : Serial Clock | INTS L,1 : External Interrupt 0, 1, 2 |
| SI : Serial Input | INTS 2 : External Interrupt 2 |
| SO : Serial Output | EL2 : Main-system Clock Oscillator 1, 2 |
| SM L : Serial Bias 0, 1 | STL2 : Subsystem Clock Oscillator 1, 2 |
| RESET : Reset | NC : Non-connection |

uPC2002
(AF POWER AMPLIFIER)



1. IN
2. NFB
3. GND
4. OUT
5. Vcc(+)

TC5090AP

(8-BIT A/D CONVERTER)



uPD4053BG

(TRIPLE 2-CHANNEL MULTIPLEXER)



uPD4094BG

(8 STAGE SHIFT STORE BUS REGISTER)



MAX232

(RS-232 DRIVERS/RECEIVERS)



MC145156

(SERIAL INPUT PLL FREQUENCY SYNTHESIZER)



uPD43256GU

(STATIC CMOS RAM)



uPD4528BC

(DUAL MONOSTABLE MULTIVIBRATOR)



uPD74HC42

(BCD-TO-DECIMAL DECODER)



uPD74HC151

(8-INPUT DATA SELECTOR/MULTIPLEXER)



uPD4066BG

(QUAD BILATERAL SWITCH)



RF COILS

PART NUMBER	MAIN UNIT	PLL UNIT	FRONT UNIT	QTY.	REMARKS
KE-05806	L16			1	198MHz
KE-05807	L11			1	352MHz
KE-03988	*L1			1	736MHz
KE-05151	*L10			1	352MHz
KE-05475	*L13			1	198MHz
KE-04971	L7, 14, 18, 19 20			5	45MHz
KE-04980	L28, 29, 31			3	455KHz
KE-05170	L2, 3, 21, 22 26, 27			6	DBM
KE-05816	L9			1	DBM
KE-05817	L8			1	DBM
KE-04266(1c)		L1, 2, 4, 5, 7, 8, 9	L4, 5, 9, 12	11	AIR WOUND
KE-03876(2c)		L3, 6	L1, 3, 6, 19, 20 34, 41, 48	10	AIR WOUND
KE-03878(3c)			L2, 21, 28, 35, 42, 45, 49, 50	8	AIR WOUND
KE-04267(4c)			L14, 43, 51	3	AIR WOUND
KE-06197(5c)			L10, 46	2	AIR WOUND
KE-06198(6c)			L29, 36, 47, 94 95	5	AIR WOUND
KE-06380(8c)			L40	1	AIR WOUND
KE-06599(2c)			L11	1	AIR WOUND
KE-06613	L30			1	44.575MHz
KE-05507		L14		1	90uH CB.

* 3 GANG HELICAL RESONATORS

FRONT PANEL ASSEMBLY

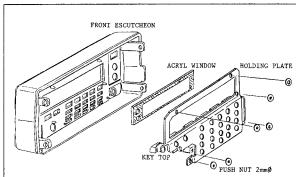

PARTS LIST(MISCELLANEOUS)

Potentiometer control	"Volume"	A50K	PRP-124-A-1007-A-1	
"	"	C10K	"	
"	"Squelch"	4.7K	(VR4 MAIN UNIT)	H0651A
"	semi fixed	10k	(VR1,2	H0651A
		47K	"	H0651A
		2.2K	(VR5	H0651A
		47K	(VR1,2,3 FRONT	RMO412C
		10K	(VR1 PLL 2nd	H0651A
Trimmer capacitor	10PF	(TC1,8,9,10,11 PLL)	CVSSA1001	(WHITE)
	7	(TC12 - 15 PLL	CVSSA0701	(RED)
	20	(TC2 - 7 PLL	CVSSC2001	(BLUE)
	10	(TC7 MAIN UNIT	CVSSA1001	(WHITE)
	20	(TC8 MAIN UNIT	CVSSC2001	(BLUE)
	50	(TC9, 10 MAIN UNIT)	CVSSG5001	(GREEN)
	20	(TC1 CPU-LCD UNIT)	CVSSC2001	(BLUE)
Switch	"power"		SKHJ12	
	"tact"		SKHHAJ10902	
	"slide"	(AMP ON-OFF FRONT RF UNIT)	SSSS21434A	
	"push"	(BAUD RATE SW CPU-LCD	SSSS21434A	
		(RESET CPU-LCD	SKHLAC0001	
Connector	"antenna"		BNC female	
	"coaxial"	(FRONT BPF/MAIN UNIT)	MM3325-2505	
	"DC power"		J-0409-01-200	
	"DIM for AUX"		TCS1290-01-0101	
	"cable/wire"	2-9 pin	TOYO-1.5	
	"remote"		WD25F-A WAKA	
Jack	"Ear phone"	3.5mm DIA.	0785-01-050	
	"Ext. speaker"	3.5mm DIA.	0863-01-410	
Knob	"Dial" with rubber ring			
	"Volume/Squelch"			
Key top	"Power"			
	"Keyboard"			
Rotary encoder switch	"Dial"		SRBM2L-1	
Light emitting diode	"green"		TLG211	
	"red"		TLR211	
Liquid crystal display			LD-H7211EZ	
Back light			L277	
Piezo electric buzzer			PKM22EPP-4001	
Lithium battery			CR2032-HA3	
Speaker			SM-66NR	
Relay			G5Y-1 OMRON 9V	
Quartz crystal units (CPU-LCD)			32.768KHz (2 phai x 6)	
			4.433MHz (2 phai x 6)	
	(MAIN)		34.33 MHz	
			44.575MHz	
			453.5 KHz CSB453.5A2	
			456.5 KHz CSB456.5A2	
			12.800MHz	
			CFZM455F	
Filters		(PLL 2nd OSC)	CFJ455K	
			SPT10.7MS2A	
			45N35B1 MCF	
Discriminator			CDB455C7	
Modules			B.P.F. P-8807B	
			D.B.M. P-8901B	
			V.C.O. P-8903B	

AR3000A EXPLODED VIEW

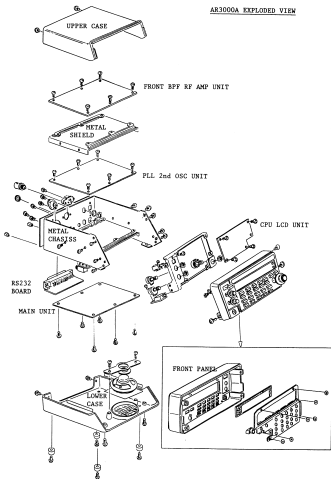

0.

J1



J2



019

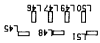

PLL ADJ.

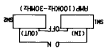

FRONT BPF RF AMP UNIT PARTS LAYOUT

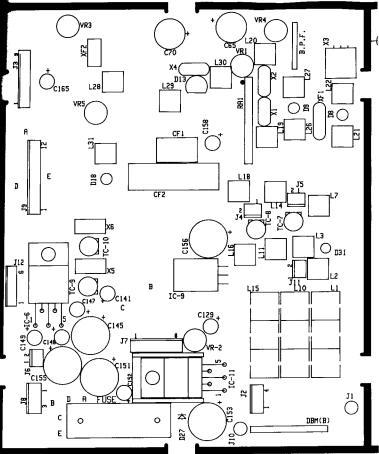

MAIN UNIT PARTS LAYOUT

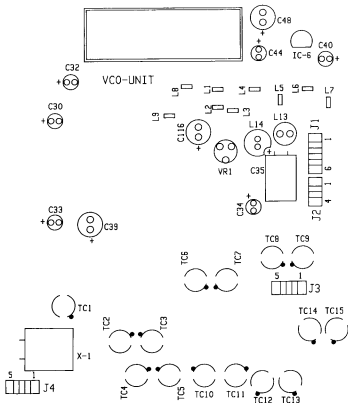

PLL, 2nd OSC UNIT
 $t=1.6$ コンポジット.

PLL 2nd OSC UNIT PARTS LAYOUT

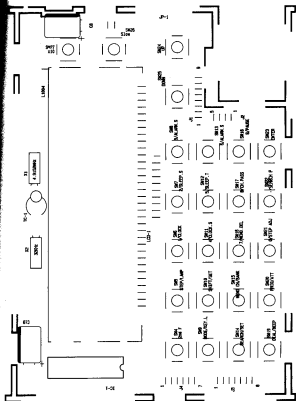

CPU/LCD UNIT PARTS LAYOUT

Downloaded by
RadioAmateur.EU

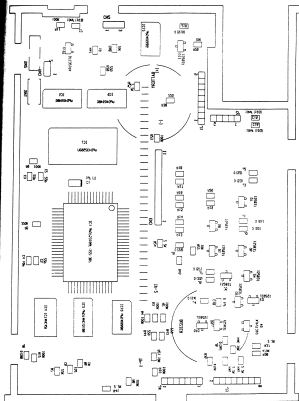

CPU/LCD UNIT SMD COMPONENTS

RE-2000R FROM UNIT 1 (0004-22264)

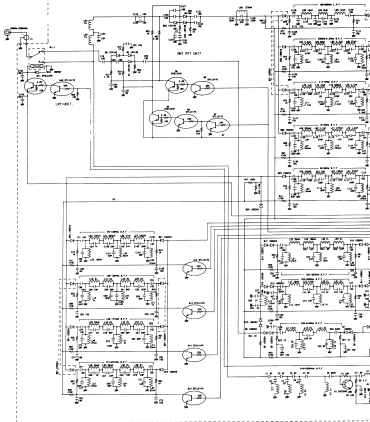

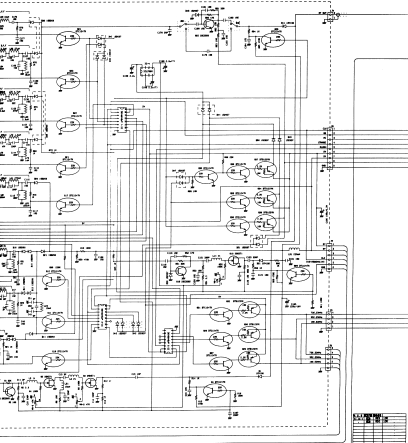

FRONT BPP RF AMP UNIT

RR-3000R IF-UNIT.

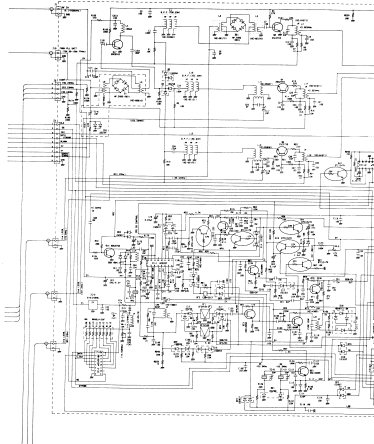

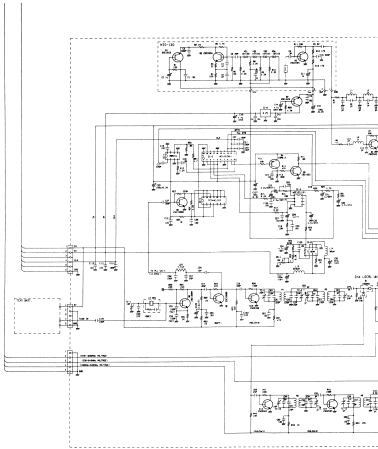

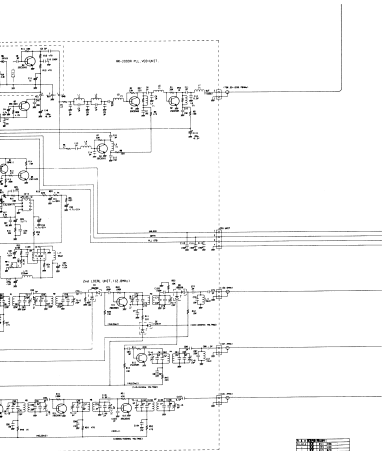

080-124

PLL 2nd OSC UNIT

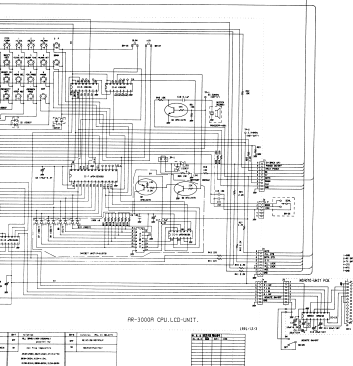

CPU/LCD UNIT