

## **160-10 Meter RXTX Modification**

Report by R. Graves, VE7VV

Revised 10 June 2020

(Original post 26 December 2015)

Please check for later revisions of these notes at

[http://gsl.net/ve7vv/Files/160-10 Meter RXTX Modification.pdf](http://gsl.net/ve7vv/Files/160-10%20Meter%20RXTX%20Modification.pdf)

**While I have provided some practical tips, this is not intended to be a complete step by step modification manual. These are notes reporting results with my project. Others interested in using this information for their own project should have sufficient understanding: of how the RXTX operates theoretically, of how the circuit board is laid out, and of practical construction techniques to fully comprehend what is involved and how to proceed on their own. If anything about these notes is unclear or confusing, do not attempt to modify your RXTX without getting additional guidance. Mistakes could be costly and could damage parts on the board beyond your ability to troubleshoot. Any modifications are at your risk and responsibility.**

**If anyone has suggestions for improvements, please let me know or post to the group.**

This all-band RXTX project began in early 2015 and continued with ongoing support and encouragement from Tony Parks. Warren Allgyer and I collaborated on this as time permitted. Warren has reported designs for a set of bandpass filters separately. I thank Joe, VA3JLF, for the excellent suggestions for improving an earlier version of this guide that he provided while modifying his RXTX.

(After posting the 26 December 2015 report, Andy informed me that he had developed a similar modification, of which I had been unaware, [Andy YL2QN's all band RXTX mod](#)).

The design for circuit board modifications evolved with critique and support from Tony and Warren. Any deficiencies with the final design are wholly mine. Reports from others about their experience with this modification would be greatly appreciated.

This modification, which retains the circuitry of the standard RXTX, involves the removal of all the original bandpass and lowpass filters, replacing transformers with broadband versions, replacing a few components with different values, and the addition of one resistor. The rationale for these changes is explained at the end of this document.

The initial goal was for 1 Watt output from 1.8 to 30 MHz. Measurements (all with 13.8 Vdc power supply and CW modulation) showed that, while the modified board can produce 1 Watt output on all bands, the level of in-band inter-modulation distortion (IMD) spurs slightly exceeds the usual standard of -43 dBc on some bands. (dBc refers to dB relative to the fundamental, "carrier", frequency power.) The level of -43 dBc was however attained with power reduced to 700 mW below 24 MHz (or below 14 MHz with the optional, and recommended, 30 MHz mixer low pass filter). If a set of switched, or plug-in, mixer filters is provided, 1 Watt output at low IMD can be achieved on all bands. These figures should be taken as best case conditions as I might have missed seeing spurs (e.g., I only looked within 50 kHz of the carrier), or made errors in measurement.

Audio drive level required for 1 Watt output was 0.58 Vrms for 28 MHz, reducing with frequency to about 0.18 Vrms below 7.3 MHz. The output power will be reduced by the attenuation within the passband of the required external filters, at least 1 dB.

**The modified RXTX board functions from 1.8 to 30 MHz but requires, and must not**

**transmit to an antenna without, the addition of external low pass or band pass filters to suppress harmonics. (See Note 5 below for filter designs.)** The required filtering is indicated by the following measurements of harmonic levels. Filter attenuation should be great enough to suppress these harmonics to below -43 dBc. All higher even and odd harmonics are also present, but at progressively lower levels.

The harmonic values presented below were measured with the 26 December design (T3 as 4T:8T center-tapped, wound as 4T:4T bifilar and R30/R31 bypassed). Subsequently I tried the 4T quadfilar design for T3 and found it to be slightly better on 24 and 28 MHz (more headroom before driver clipping and lower IMD) and that the original R30/R31 bypass (done to increase available drive) was not required. I believe that the harmonic levels would be no worse with the new design, but a new set of measurements is needed.

Freq.	2nd harmonic dBc	3rd harmonic dBc
1.8	-40.5	-9.0
3.5	-36.5	-11.5
7.0	-32	-15
10.1	-30	-17
14	-29	-19.5
18.1	-28	-20.5
21	-30.5	-20.5
24.9	-32.5	-21
28	-33.5	-19

### **Modifications to the RXTX circuit board.**

**Before changing anything, test your unmodified RXTX. Confirm that the receiver is working and that the transmitter produces about 1 Watt output on whichever bands it was designed for.**

**If, at each stage of testing suggested below, the power out is not at least as high as originally on the bands the radio was designed for, something is wrong and you need to correct the problem before continuing.**

1a) C64, C66, C67, C68 (DC supply SMT bypass caps) should be 0.1 uF as used in the four lower frequency RXTX versions. The .01 uF value used on the 15/12/10 mtr version might not be large enough for the lower bands. To avoid the possibility of instability (feedback, oscillation) problems, if you have a board with the .01 uF caps I recommend replacing them with 0.1 uF, or adding 0.1 uF caps in parallel, before proceeding with the following steps.

b) C70 and C71, which are .01 uF on all RXTX boards, are recommended to be replaced or paralleled with 0.1 uF caps (as used at these locations in the Ensemble II) in light of Ron G4GXO's report of RX I/Q phase errors with the stock value of C70.

<https://groups.yahoo.com/neo/groups/softrock40/conversations/messages/84629>

Furthermore, it is recommended (but not essential) to add a 33 uF cap (observe polarity) in parallel with the 0.1 uF ceramic cap at C70 in light of Erik, PD0EK's report

<https://groups.io/g/softrock40/message/87831?>

[p=...20,0,0,0::Created,Using+Softrock+ensemble+II+RXTX+as+all+band+FT-8+transceiver+%23ft8,20,2,20,55843839](https://groups.io/g/softrock40/message/87831?p=...20,0,0,0::Created,Using+Softrock+ensemble+II+RXTX+as+all+band+FT-8+transceiver+%23ft8,20,2,20,55843839) this will improve the RX I/Q phase error.

**Test that both the RX and the TX are working as before (same power output).**

2) Remove or replace the three RF low pass and bandpass filters.

a) Remove the low pass filter at the antenna input. Specifically remove C24, C25, C26, L2 and L3. Then add a jumper (bridge) wire connecting the pad at the antenna side of L3 to

the pad at the PA side of L2. **This filter must be replaced later by an add-on (external) band pass or low pass filter, see Note 5.**

**Test that both the RX and the TX are working as before (same power output).**

- b) Remove the filter between the TX mixer and driver. Specifically, remove C20 and L1 and replace C21 with a .015 uF disk ceramic capacitor.

Then either:

- i) add a jumper wire where L1 had been, or
- ii) replace the old filter with a 30 mHz low pass filter by replacing C20 with 270 pF, replacing L1 with 230 nH (7T evenly spaced on a T30-6 yellow toroid, which is the toroid used for L1 in the three highest frequency RXTX versions) and adding a new 270 pF capacitor from the Q6 side of L1 to the nearby ground end of R43 (VA3JLF suggests installing this 270 pF cap on the underside of the board). This forms a PI filter, or
- iii) replace the old filter with a set of switched or plug-in filters that will cover all bands. Andy, YL2QN, has designed and built a switched filter for his RXTX mod. The set of filters described in Note 5 could also be duplicated (50 V caps would be sufficient) and used for this purpose.

**The addition of the option ii filter is strongly recommended as it reduces the level of IMD spurs on 14 mHz and above. Option iii would reduce IMD on all bands. See Note 1 below for measurements of IMD with and without mixer filters.**

With option i), power output should be limited to 700 mW below 24 mHz.

With option ii), power output should be limited to 700 mW below 14 mHz.

With option iii), power output could be 1 Watt on all bands.

**Test that both the RX and the TX are working as before (same power output).**

- c) Remove the filter before the RX mixer. Specifically, remove C39 and L4. Then either:

- i) add a jumper wire where L4 had been, or
- ii) replace the old filter with a 1.8 mHz high pass filter.

If the add-on filters after the PA are a low pass type, the addition of a 1.8 mHz high pass filter before the RX may be needed to prevent overload and intermodulation from high power medium wave broadcast band signals. This may not be needed if the add-on filters are band pass type. See below for additional info re. C27. **See Note 4 below for filter design.**

**Test that both the RX and the TX are working as before (same power output).**

3) Replace components with different values as follows.

RFC1      rewind with 6T instead of 4T to provide more inductance for 1.8 mHz.

C21        .015 uF    (if not already replaced in step 1b above)

C22        .015 uF

C27        1800 pF   (this provides -3dB rolloff at 1.8 mHz for the RX).

Smaller values, such as 330 pF, 390 pF, 560 pF as used in the lower band versions, would reduce the sensitivity on 160 and 80 mtrs (and to BC band overload), which might be desirable.

**If a 1.8 mHz highpass filter is installed before T5, C27 should be .015 uF.**

**Test that both the RX and the TX are working as before (same power output).**

4) Replace transformers as follows.

**Use either BN43-2402 or BN43-1502 binocular cores.**

I used BN43-1502 cores for T2, T3 and T4 because the larger holes made it easier to wind them using larger size wire (#26). The smaller BN43-2402 cores (with #30 wire) should work also, as far as I know. Do not use type 61 cores.

**For all the ferrite core transformers, to avoid unwanted coupling make sure that**

**no leads (other than the primary and secondary wires) carrying significant RF currents touch or are closer than 1/8 inch from the core.**

a) Replace

T5 4T:2T bifilar (This is the same as used in the Ensemble II and III units.)

b) **If you have either the 160 or the 80/40 version of the RXTX, skip this step as these versions already have the required T6 and T4 transformers and the RX should now be working on all bands.**

Note: If you have either the 160 or the 80/40 version of the RXTX, consider replacing R55 and R58 with 10 Ohm resistors, as used in the Ensemble II and III as well as in the three higher frequency RXTX versions, rather than the 49.9 ohm value of the two lower frequency versions. (10 Ohms provides 14 dB more gain from the op amps than with the 49.9 Ohm resistors and, unless your RX sound card has very low noise level, this will likely improve the sensitivity on the higher frequency bands.) With 10 Ohm resistors the modified RXTX receiver should work as well as does the Ensemble II on all bands.

Replace

T6 4T bifilar (This is the same as used in the 160 and 80/40 RXTX versions, and is the same as used for the antenna isolation transformer in the Ensemble II and III.)

**Test that both the RX and the TX are working as before.**

The RX should now be working on all bands.

T4 4T bifilar primary:5T secondary on a BN43 type core.

If you have the 160 or 80/40 mtr version of the RXTX, you do not need to change T4 as these versions already use a BN43 core.

**Test that both the RX and the TX are working as before (same power output).**

c) Replace

T2 4T bifilar primary:4T secondary (can also be wound as 4T trifilar).

see [http://www.wb5rvz.org/ensemble\\_rxtx/09\\_qse](http://www.wb5rvz.org/ensemble_rxtx/09_qse) for connections.

**Be careful that the core is spaced 1/8 inch from R30 and R31, otherwise nulling of the image will be difficult and will vary with frequency.**

**Test that both the RX and the TX are working as before (same power output).**

**If your RXTX was either the 160 or the 80/40 meter version, you should now have TX output on all bands. Check the output power from 1.8 to 28 MHz and consider whether this is now adequate. If so, you could stop here and not continue with the next steps.**

d) Replace

T3 8T primary:8T center-tapped secondary, wound as 4 turns quadfilars.

**If you have the 160 or 80/40 mtr version of the RXTX, you may not need to change T3, see Note 2.**

**See Notes 2 and 3 below re. how to wind this transformer and how I installed T3.**

**Be careful to space the core 1/8 inch from the 30 Ohm resistor and its leads.**

**Test that both the RX and the TX are working as before (same power output).**

With my board, at this point I was getting 1 Watt output except on 28 MHz, where the power was about 0.7 W. Changing components as follows allowed for 1 W on 28 MHz.

5) Replace components with different values as follows.

R42        10 ohm  
R43        24 ohm  
R44        1500 ohm  
R45        560 ohm

**Do not test the TX until the next step is completed or Q6 will overheat.**

Add a 30 ohm resistor in series with the T3 primary - **see Note 3 below**. This resistor is needed to reduce the power dissipation in Q6 since the collector current is increased with the new biasing. R44 should connect, as in the standard circuit, at the Q6 collector.

Q6 DC voltages (measured with no audio drive but with PTT on) should now be about 1.65 Vdc emitter (hot side of R43) and 8.50 Vdc collector (Q6 case).

**Test that both the RX and the TX are working.**

There should now be 1 Watt output from 1.8 to 28 mHz, but the audio drive required will be about 10 dB less on 1.8 than at 28 mHz. This is because the input impedance of the mosfet PA drops significantly at the higher frequencies. Therefore, be very careful not to overdrive on the low frequencies, which would produce increased spurious output and increased harmonics. Also, as Leif has advised

<https://www.youtube.com/watch?v=UBT-DT-oZuI>

it would be best to run the TX sound card audio output at maximum and then reduce the audio drive to the required level using attenuators in the TX audio input lines. This will decrease the level of wideband modulation noise, which could be high with some sound cards if more than 10 dB of audio reduction is done by reducing the sound card output level in software.

**Additional consideration.**

C11, C12, C13, C14 are only 10 uF in the stock RXTX. This is adequate for audio drive frequencies greater than 3 kHz. However, if you intend to use lower frequencies, e.g. for digital modes close to the LO, or if you use PowerSDR or GSDR where the LO is shifted during transmit such that the audio modulating frequencies will be within the filter bandwidth (e.g., 150 to 2400 Hz), then these capacitors should be increased. I used 10 V 220 uF electrolytic caps of low electrical series resistance (low ESR) type. The Panasonic FR line is good. I also added a 220 uF cap on the 5 V line near the TX op amps.

## Notes

**Note 1. Measurements of the level of the LO-3\*mod IMD spur (dBc) with 1 Watt output (mod = 2 kHz).**

The LO-3\*mod spur (e.g., if Local Oscillator=14.100 and modulation tone=2 kHz for a signal at 14.102, this spur would appear at 14.094) is the strongest one that I typically see. The level of this spur can be substantially reduced by installing a low pass filter after the mixer and before the driver stage, i.e. at the location of the L1/C20 filter in the standard circuit. The reason a low pass filter after the mixer reduces this spur is that this spur is, according to SM5BSZ, produced by mixing (in the RF amp stages) of TX mixer spurious outputs, namely (3\*LO-mod) - (2\*LO+2\*mod) = LO-3\*mod. Other spurs result from different combinations of mixer output components - all of this type of IMD product will be reduced by mixer low pass filtering.

Evaluation of a 30 mHz 3<sup>rd</sup> order Chebyshev low pass filter (270 pF-230 nH-270 pF PI) placed after the mixer.

Freq.	No mixer filter	30.0 mHz mixer LP filter	Change
1.852	-43.2	-41.4 (-45.0 @ 700 mW)	
3.602	-42.1	-41.5 (-46.3 @ 700 mW)	
7.102	-40.9	-40.2 (-43.2 @ 700 mW)	
10.102	-41.0	-41.9 (-43.8 @ 700 mW)	
14.102	-39.8	-47.4	7.6 dB better
18.102	-39.3	-55.8	16.5 dB better
21.102	-42.1	-58.7	16.6 dB better
24.902	-53.5	-60.5	7.0 dB better
28.102	-45.7	-58.4	12.7dB better

**Because of the reduced IMD, the addition of this filter is strongly recommended.**

Evaluation of a 14.3 mHz 3<sup>rd</sup> order Chebyshev low pass filter (510 pF-516-nH-510 pF PI) placed after the mixer.

Freq.	No mixer filter	14.3 mHz mixer LP filter	Change
1.852	-43.2		
3.602	-42.1	-42.9	none
7.102	-40.9	-49.6	8.7 dB better
10.102	-41.0	-63.8	22.8 dB better
14.102	-39.8	-67.2	27.4 dB better
18.102	-39.3	(Operation above 14.3 mHz is not possible with this filter in place.)	
21.102	-42.1		
24.902	-53.5		
28.102	-45.7		

Evaluation of an experimental set of 6 relay-switched mixer filters.

Freq.	No mixer filter	With filters	Change
1.852	-43.2	-65.9	22.7 dB better
3.602	-42.1	-66.7	24.6 dB better
7.102	-40.9	-70.8	29.9 dB better
10.102	-41.0	-62.0	21.0 dB better
14.102	-39.8	-52.6	12.8 dB better
18.102	-39.3	-59.4	20.1 dB better
21.102	-42.1	-57.0	14.9 dB better
24.902	-53.5	-49.8	3.7 dB better
28.102	-45.7	-50.8	5.1 dB better

(Stray circuit board capacitance probably limited attenuation at the higher frequencies.)

**This shows that the use of a set of properly designed low pass mixer filters, switched or plugged-in for the appropriate bands, would substantially reduce the IMD and allow operation at 1 Watt output on all bands.**



**Note 2. Quadfilair winding of T3 using BN43-1502 binocular core.**

If you are using a BN43-2402 and have difficulty winding 4 turns, use 3 turns. I found that (with the BN43-1502) 4T supported a better waveform on 160 and was still as good on 10 meters, but 3T should be OK since that is what is used in the standard RXTX 160 and 80-40 meter versions.

Take two lengths of wire (using different colors makes it easier) 14 inch long. I used #26.

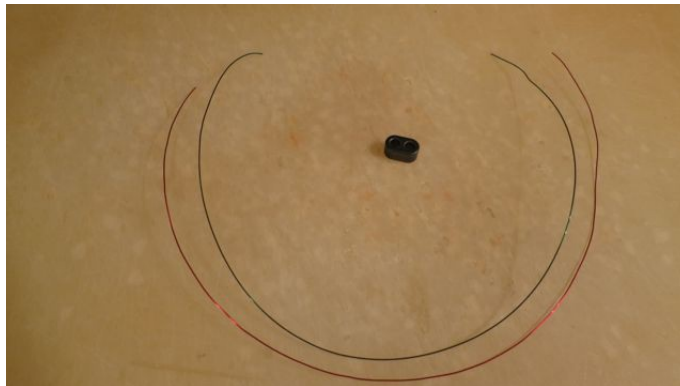

Bend each wire in half and crimp each bent end so it is flat.

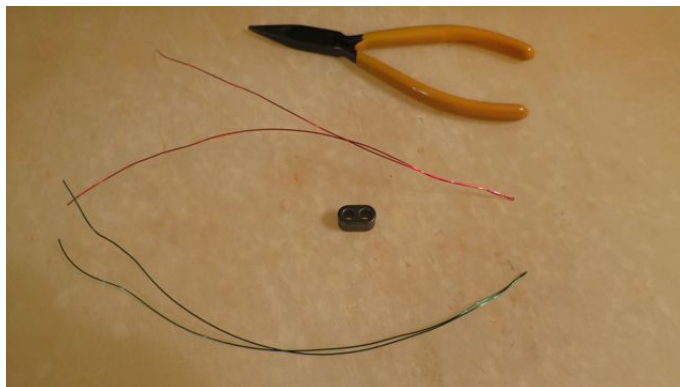

Twist the two doubled lengths together, making a single bundle of 4 wires.

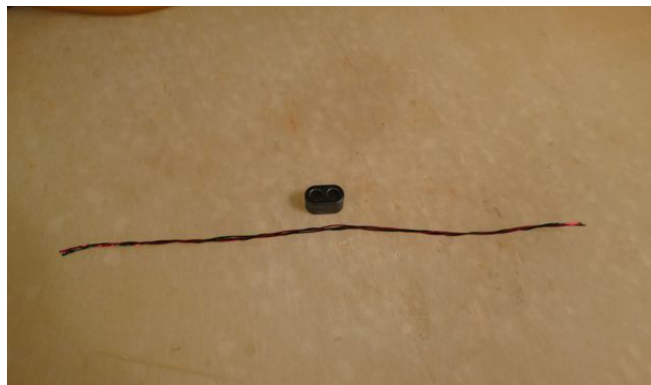
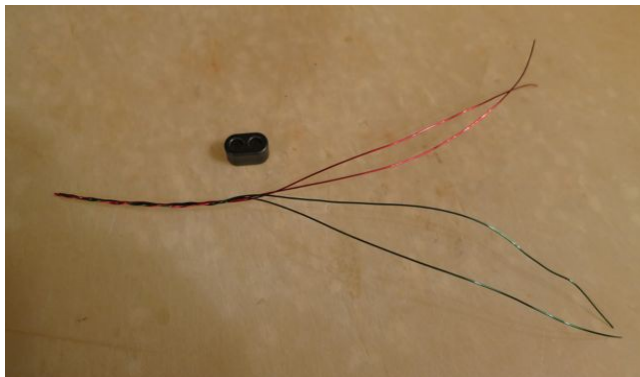

The end of this bundle that has the two loose crimped doubled ends is used to wind 4 turns through the core. I was careful to keep the windings adjacent as much as possible, not crossing over each other, to maximize the available space. A wood round pointed toothpick is useful to pack the windings to make space for the next pass. Be careful not to scrape the wire

against the edge of the hole as you pull it through as it is easy to strip off the insulation and then there can be a short.

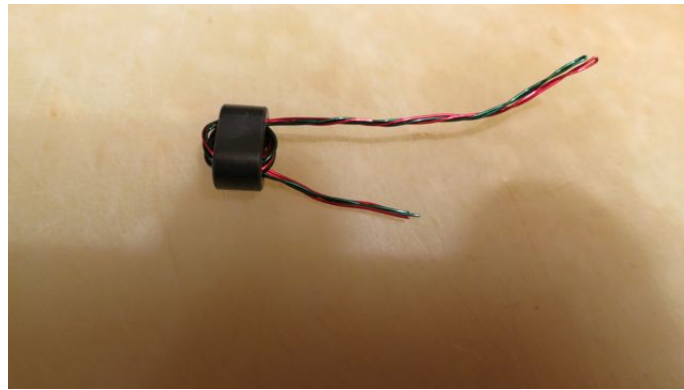
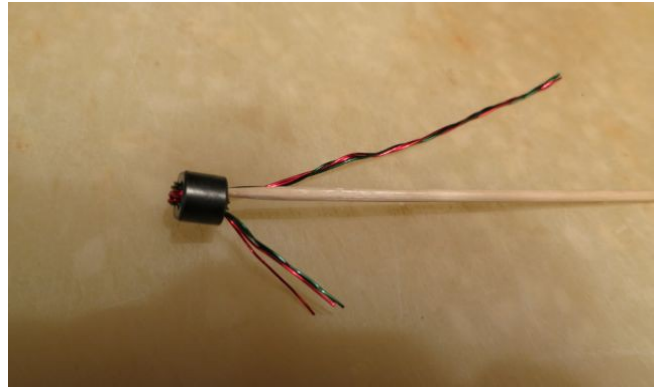
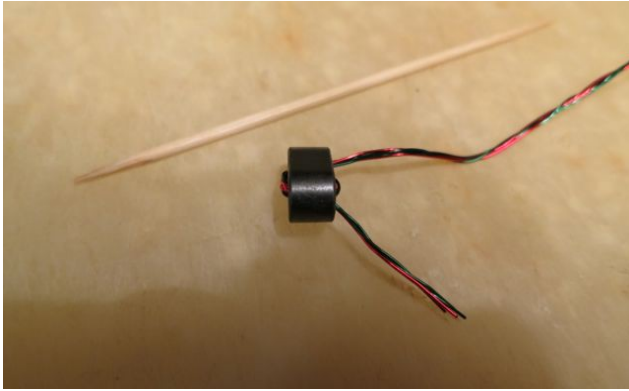

Trim the two doubled ends off so now there will be 8 ends (4 wires).

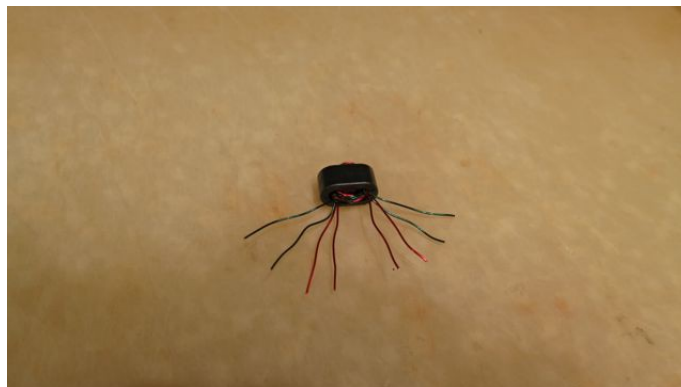

Then you connect up two wires to make one 8 turn center-tapped winding (using one color if you had two colors), then connect up the other two wires to make another 8T center-tapped winding. One of those becomes the secondary with its center tap used. The other one is the primary with no connection to the center tap.



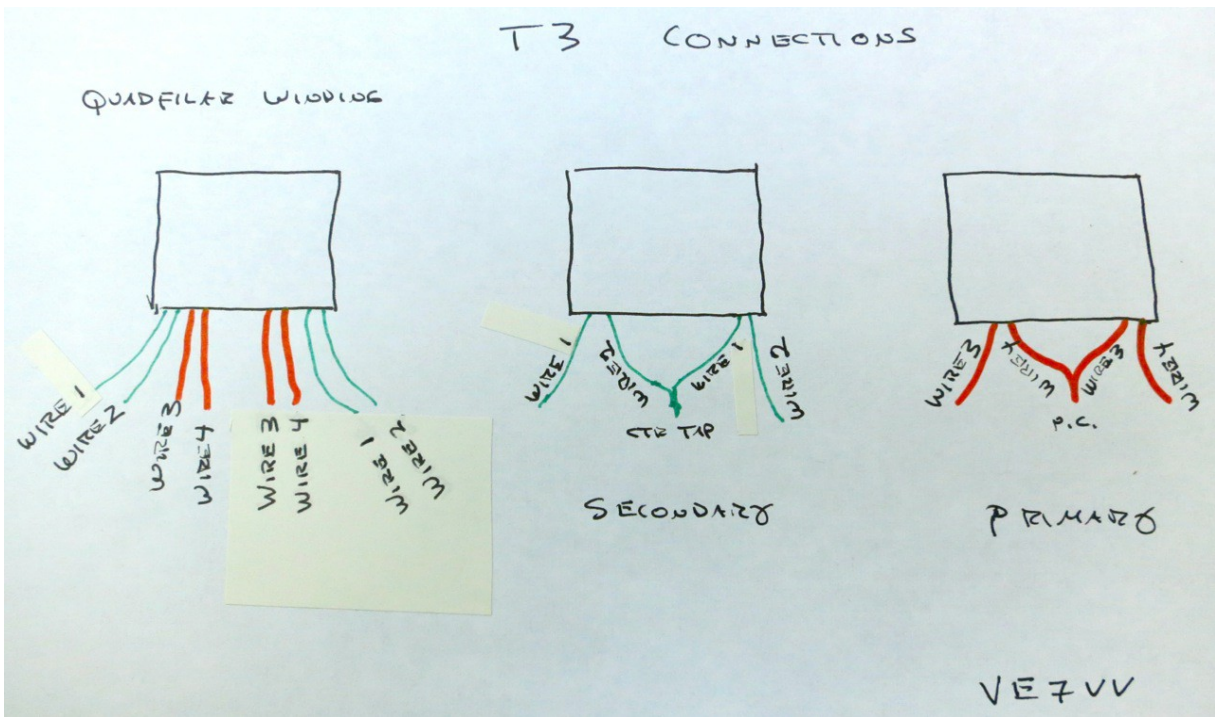

Use an Ohmmeter to make sure you connect up two *different* wires (Ohmmeter shows there is no connection).

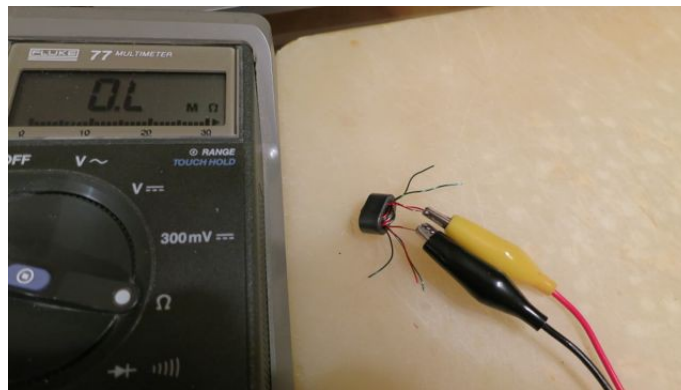

**Finished!**

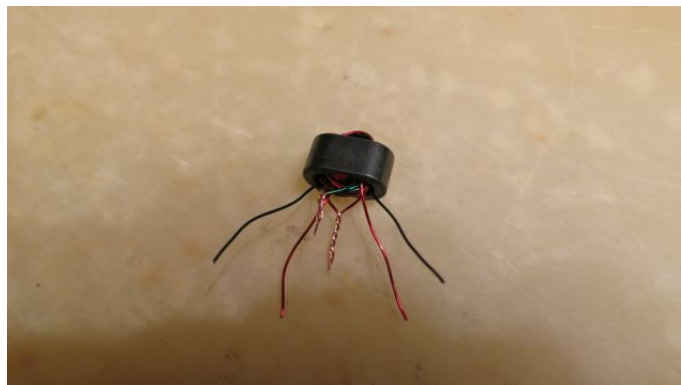

### Note 3. 30 ohm resistor and T3 installation.

The **primary center tap wires MUST NOT BE CONNECTED TO ANYTHING**. The soldered pigtail should not touch anything and ideally should be covered with a short piece of insulation. The 12 Volts on that wire will almost certainly damage something if it touches almost anything. You should also check, before installation of T3, with an Ohmmeter, that the primary and secondary windings are not shorted. A short here would put a high voltage bias on the PA mosfet gates which would likely destroy them and possibly other components as well.

The way I connected T3, there will be **5 connections** to the board, two for the primary, two for the hot leads of the secondary, and one for the secondary center tap (which if you install T3 "right side up" would go to either of the original two center tap holes on the board).

**Optionally**, you could not solder together the two wires that form the secondary center tap and instead connect them into the two holes on the circuit board (that are themselves bridged together) for the original T3 secondary center tap, in which case there would be **6 connections** to the board.

The way I actually installed T3, because I knew I would be doing this many times with different test versions of T3, was to solder 4 "posts", the 30 Ohm resistor plus 3 short pieces of insulated wire, into the primary and secondary holes on the circuit board. (The fine solid copper insulated wire from 4 conductor telephone wall cable works great for this purpose.) I then installed my T3 "upside down" between the primary and secondary wires and soldered the leads from the core to the post wires that were now easily reachable. The secondary center tap was soldered to the hairpin of either R46 or R47, **which if they were installed according to Robby's drawing** will be connected to the center tap traces.

**Electrically**, you want the new T3 to be connected to the board the same way the original T3 was - primaries to the primary holes, secondaries to the secondary holes, secondary center tap to the secondary center tap hole(s). Keeping this in mind should indicate how T3 is connected.

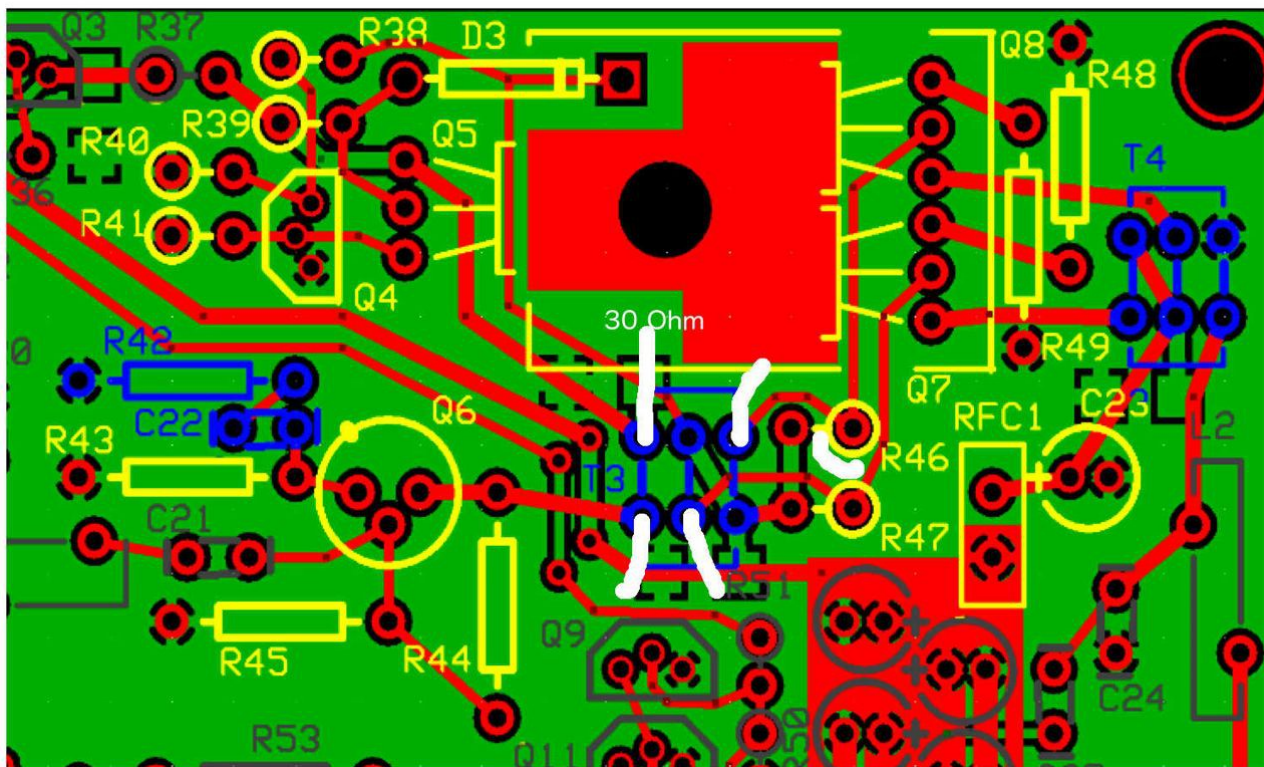

As shown on the circuit board illustration above, the two white lines on the *left side* show



connections for the T3 primary. I installed a 1/4 W 30 Ohm resistor vertically in the top hole (but it could as well go into the bottom hole) and a short vertical insulated wire in the other hole. I then soldered my T3 primary leads to the top of the 30 Ohm resistor (so the 30 Ohm resistor will be in series with the primary) and to the top of the vertical wire. (I installed T3 “upside down” to make it easy to access the connections.)

The two white lines on the *right side* show connections for the T3 secondary. Short vertical insulated wires were installed into the board holes for the “hot” secondary connections. T3 secondary leads were soldered to these wires. The center white line on the right indicates where I soldered the secondary center tap lead - to the hairpin of R46. The photo below shows my actual installation. (The red insulation tubing covers the lead from the 30 Ohm resistor.)

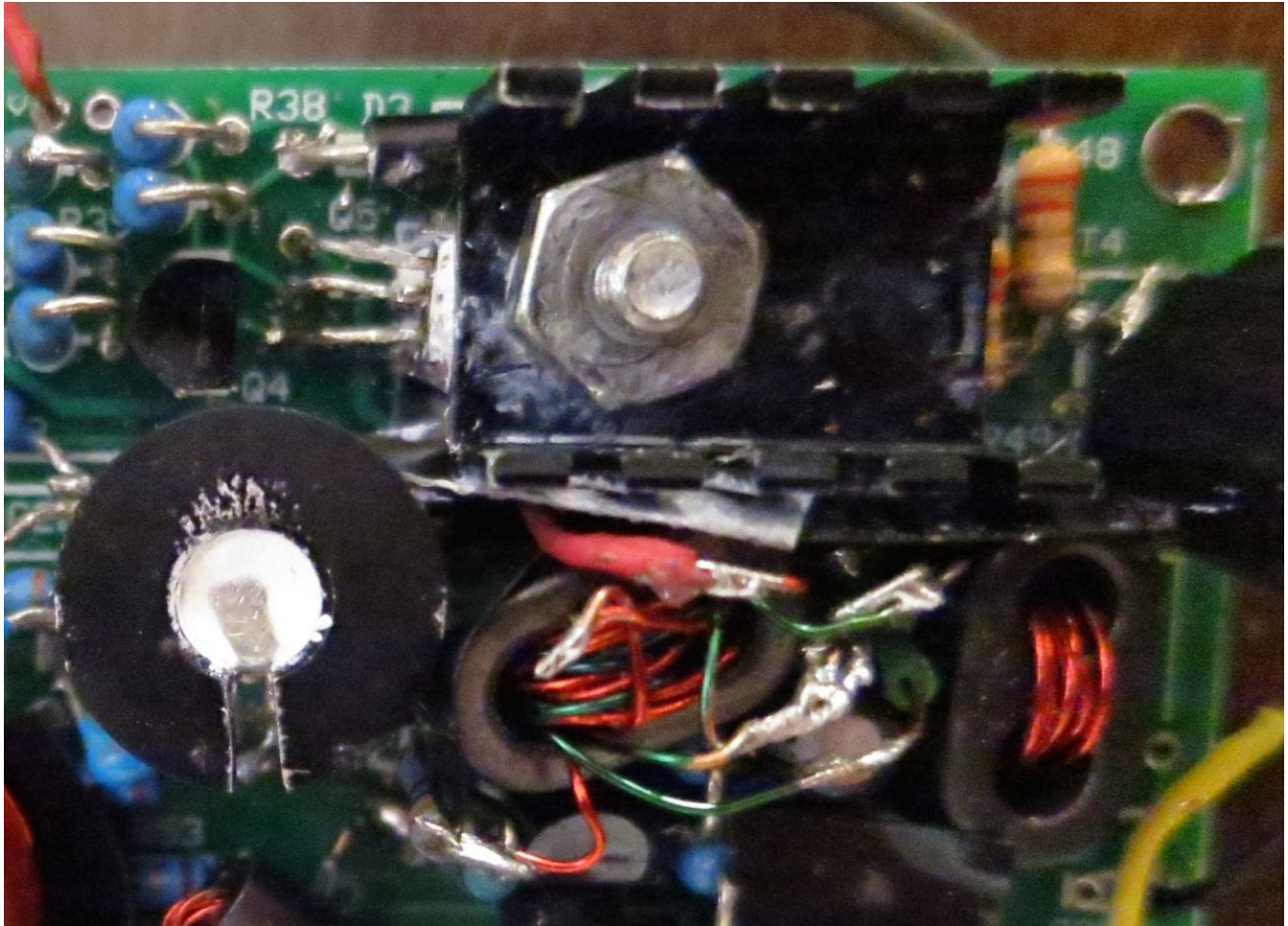

#### **Note 4. 1.800 MHz high pass receive filter.**

Adding this filter will provide some protection from strong signals below 1.8 MHz, such as medium wave AM broadcast stations. If the BC band attenuation is not sufficient with this filter, a 5<sup>th</sup> order filter could be substituted. If your location is subject to strong signals on other frequencies, such as short wave broadcast, some other type of filter may be needed.

Functionally, this filter could be either a T or a Pi configuration. The T configuration uses fewer inductors which are large if hand-wound toroids are used and space is limited near T5. If a T configuration is used, I discovered that the RXTX T/R switch circuit requires a DC ground path on the Q10 source. A T configuration filter would not provide this. A pi configuration filter (with input inductor to ground) would be OK. Alternatively, adding a resistor to ground before the T

filter would suffice. I found that a 1 kOhm resistor worked well. Caps Ceramic C0G (NPO).

Third order Chebyshev high pass filter, "T" configuration with the added resistor.

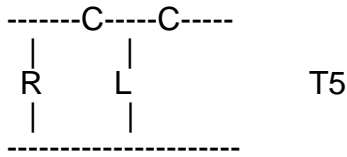

with 1 kOhm, 560 pF, 5.9 uH, 560 pF.

The inductor could be wound as 37 T on a T30-2 (red) toroid core.

This can be installed by: connecting the two capacitors in series and soldering the two ends into the holes for L4, then soldering one lead from the inductor to the common connection of the two capacitors and the other lead into the grounded hole for C39.

A third order Chebyshev Pi configuration high pass filter could be

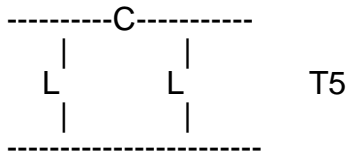

with 1.2 uH, .0027 uF, 1.2 uH.

Small molded inductors would save space over toroids.

**Note 5. Add-on external filters.**

The third order bandpass filters designed by Warren, which contain three inductors for each of the six bands, should be excellent if carefully constructed to meet his specifications.

Simpler low pass (LP) filters should provide the needed attenuation of 2<sup>nd</sup> and 3<sup>rd</sup> harmonics of the transmitter. For ease of construction I opted to use this type of filter. The disadvantage of using low pass rather than band pass filters is the lack of attenuation of frequencies below the operating bands, which could be a problem for the receiver if there are strong signals, such as nearby high power ham stations operating on lower bands.

Third order Chebyshev "Pi" configuration LP filters would be sufficient for the following bands.

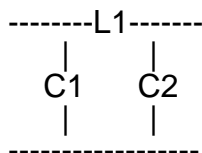

Band	C1, C2	L1*	Winding**
160	4700 pF	2.63 uH	25T over 100% of T30-2 (red)
80	1500 pf	1.72 uH	20T over 100% of T30-2 (red)

**This 80 mtr filter does not work on 60 mtrs.**

**For 60 mtrs, use a separate filter, or design a higher order 80-60 filter.**

20	560 pF	0.43 uH	8T over 50% of	T30-2 (red)
17-15	220 pF	0.41 uH	9T over 55% of	T30-6 (yellow)
12-10	220 pF	0.26 uH	7T over 60% of	T30-6 (yellow)

For 40-30 mtrs, a 5<sup>th</sup> order LP filter is needed.

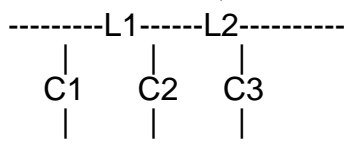

Band	C1	C2	C3	L1, L2
------	----	----	----	--------

40-30            560 pF   820 pF   560 pF   0.88 uH   13T over 90% of T30-2 (red)

For all of these filters, capacitors should be 5% tolerance disk ceramic, C0G (NPO) type, at least 100 V rating (higher voltage rating types, e.g. 630 V, would be best).

- \* All inductances are as given by filter design software.
- \*\* All windings are as determined empirically for best SWR by pushing the turns over more or less of the circumference of the toroid with the filter terminated in 51 Ohms and connected to an MFJ-259B analyser.

I constructed the filter using a 3 pole 6 position switch.

<http://www.ebay.ca/itm/171092308910>

The input and output "hot" leads of each filter are connected to the outer decks and the ground of each filter is connected to the middle deck. The 12/10 meter filter is connected to the switch contacts closest to the wiper contacts to minimize lead lengths for this highest frequency filter. The other filters are connected in sequence with the 160 filter on the contacts the furthest from the wiper terminals.

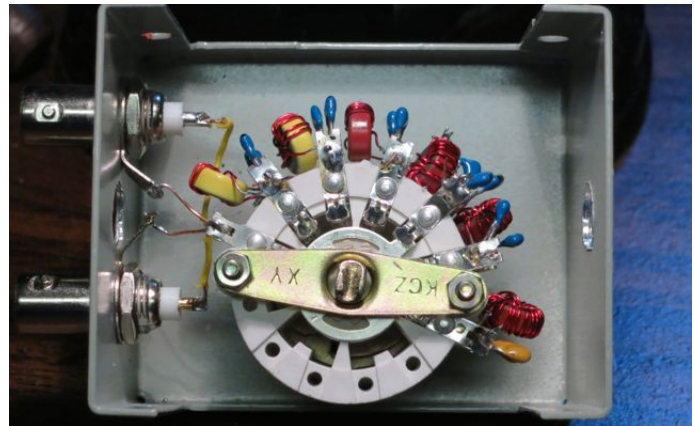
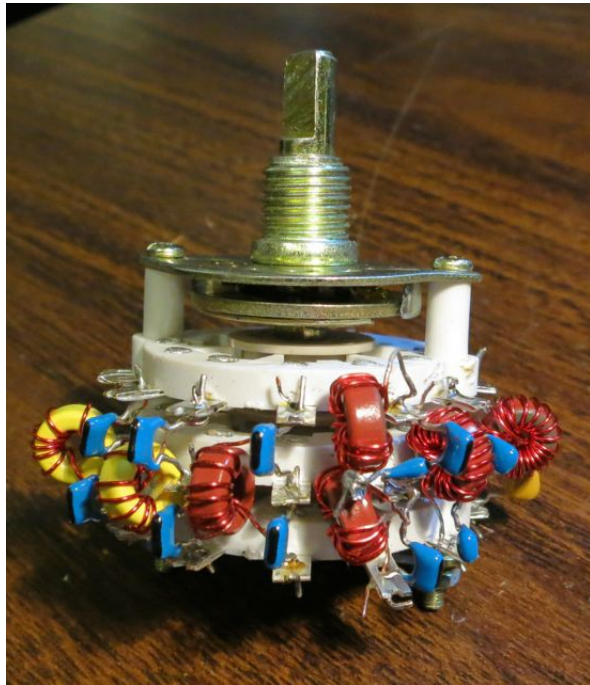





## Rationale for the changes.

1) The removal of the three existing RXTX filters, which limit operation to specific sets of frequency bands, is needed to allow operation over the entire 1.8 to 30 MHz range.

a) The lowpass filter at the antenna input functioned to suppress harmonics on TX and to limit overload to the RX from frequencies above the highest band. This filter needs to be replaced by an adequate new filter that could be connected either in the same location or as an external unit (or be part of an added linear amplifier). As far as suppression of harmonics is concerned, the new filter could be either a low pass or bandpass design as long as it had sufficient attenuation of the harmonics. A band pass design would be preferable for the RX since it would also protect the RX from overload from strong signals below the operating band, in particular from BC band stations.

b) The bandpass filter between the mixer and driver functioned mainly to suppress harmonics of the LO and main TX signal from reaching the mixer.

My design is an attempt to provide a simple and relatively easy to implement all-band modification. Measurements above show what can be accomplished when this filter is omitted. **However these measurements show that the IMD would be significantly improved if a low pass filter is installed at this point.** A 30 MHz low pass filter could be installed after the mixer, replacing the original filter, which would improve the IMD for 14 MHz and above (see table below). However, filters for the lower bands would have to be switchable to select the needed one for the desired frequency.

c) A simple *low pass* filter before the RX mixer input. I am not sure why this was provided in the original RXTX design. However, if a low pass filter (instead of a band pass filter) is used at the antenna input, it would be desirable to have a *high pass* filter at the input of the RX to suppress BC band and below.

2) Change in bias for the driver stage. The most difficult problem I encountered in developing this mod was finding transformer designs that would function over the whole frequency range. The issue is that when enough turns are used to provide the inductance needed to make it work at 1.8 there may then be too much capacitance to work at 28 MHz. This problem is greatly worsened by the fact that the PA mosfet input impedance drops significantly at 28 MHz, making the drive requirement the worst at this frequency. The T3 transformer that I found that would work across this range presents a low impedance at 28 MHz, thus requiring a small emitter bypass resistance. Consequently, in order to get enough voltage swing on the emitter resistors I needed to lower the emitter resistor to 24 ohms and increase the Q6 current. The above biasing setup was what I found would work.