

# THE LC TESTER

*Measure capacitors, inductors, and coils with this handy piece of test equipment*

Sometimes the exact value of small capacitors and inductors used in an RF circuit isn't too important because the circuit can be brought to resonance with the slug in a coil or a trimmer capacitor. However, multipole lowpass and bandpass filters, high-performance crystal filters, or phase shift networks are circuits that can require close tolerance components and there's no slug or trimmer which will compensate for error in a value. My LC Tester (front and back views shown in **Photos A** and **B**) measures capacitors to 2000 pF and inductors to 50 microhenries with 1-percent accuracy.

## Theory

The tester measures components by the frequency change they produce in an oscil-

lator. This concept isn't new; the Tektronix model 130 "LC Meter," a '60s instrument, displayed oscillator shift at 140 kHz on an analog meter whose scale was calibrated directly in inductance and capacitance values.

The schematic of **Figure 1** is a JFET Hartley oscillator operating at about 1 MHz, buffered by two transistors to drive an external frequency counter. In use, frequency is measured twice—first without any part connected, then with the unknown inductor or capacitor. The value of the unknown part can then be calculated. The formulas, with examples worked out, appear in the sections headed **Calibration** and **Example**. A simple computer program makes the tedious computations relatively easy.

Calibration of both inductance and capacitance requires one known capacitor; the accuracy will be directly proportional to the

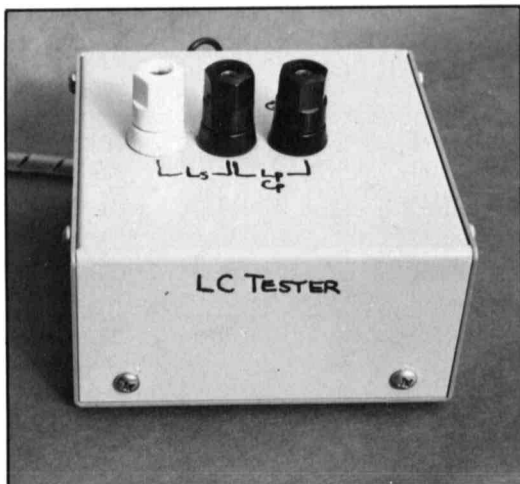

Photo A. Front view of LC tester.

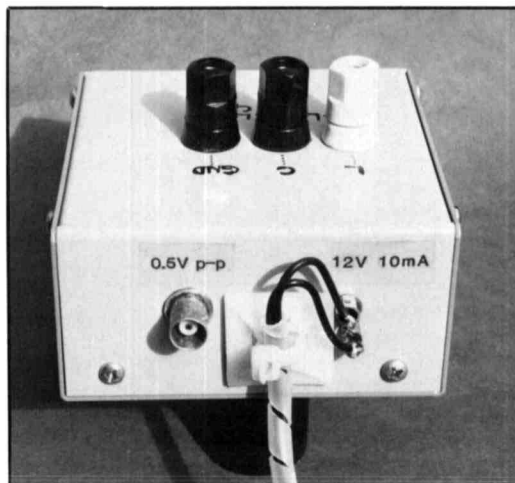

Photo B. Rear view of LC tester.

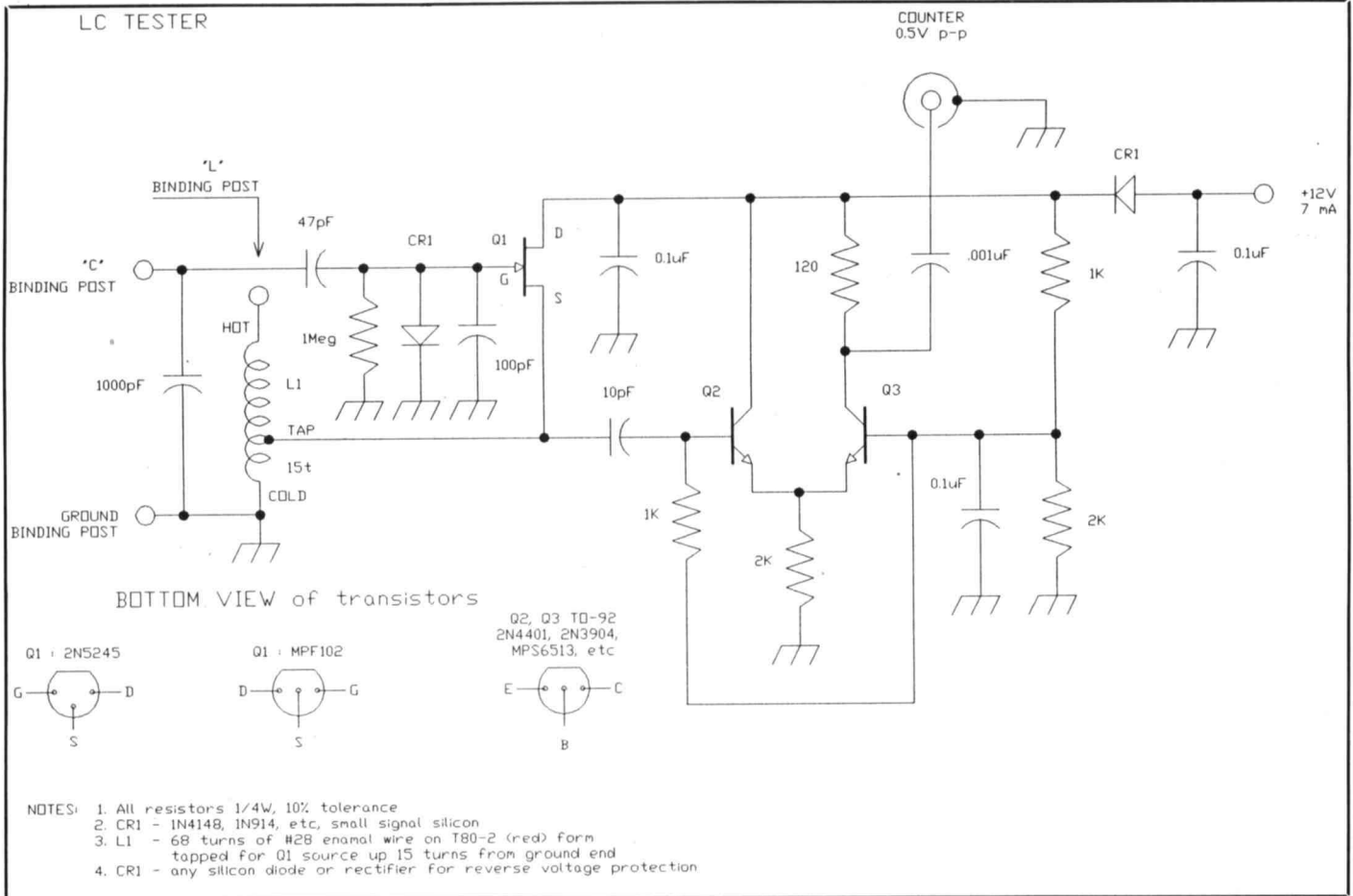

Figure 1. JFET Hartley oscillator operates at approximately 1 MHz and is buffered by two transistors to drive an external frequency counter.

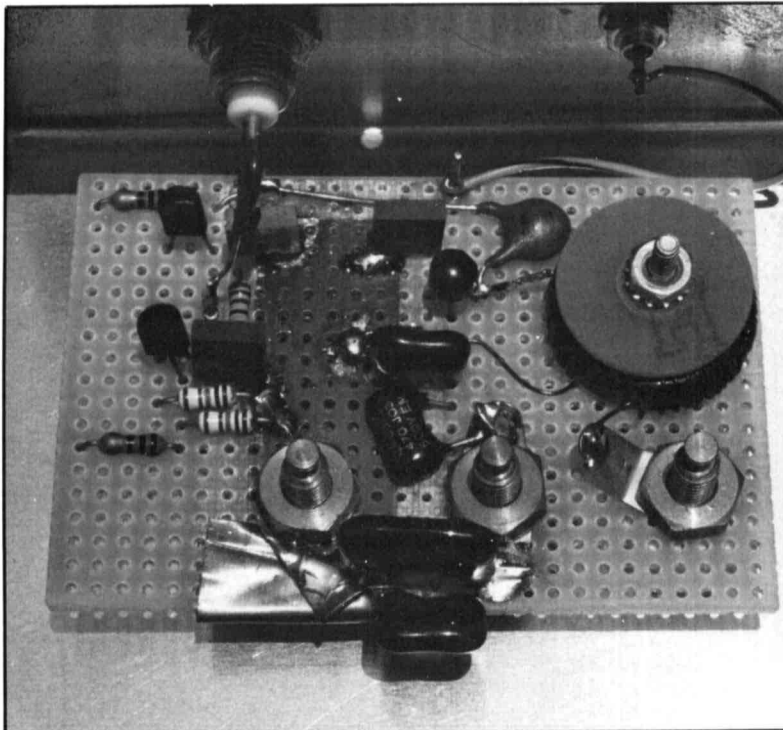

Photo C. The nominal 25- $\mu$ H tank coil is wound on a T-80-2 (red) powdered iron toroidal form and clamped to the perfboard with a screw and fiber glass washer.

accuracy of that capacitor. I've found one mail order source\* of dipped mica capacitors that can provide 1 percent + 0.1 pF accuracy. Swapmeets and surplus stores occasionally yield 1 percent, or even 1/2 percent, dipped mica capacitors. If you have even one-time access to a bridge to accurately measure your calibration capacitor, you'll find that it's easy to maintain 0.25 percent + 0.1 pF accuracy.

## Construction

I built the tester in a 4 by 4 by 2-inch aluminum box (LMB CR-442) as if it were a

\*All Electronics, P.O. Box 567, Van Nuys, California 91408 (800)826-5432, has a limited supply of the following dipped mica capacitors that can be used for calibrating the tester: DMCP-3106, 20.6 pF; DMCP-3803, 38.3 pF (only a few left); DMCP-4909, 49.9 pF; DMCP-7906, 79.6 pF (only a few left); DMCP-291, 291 pF.

Although they do not have an advertised tolerance, ten DMCP-291 tested in my Boonton bridge (1/4 percent original accuracy) averaged 292.7 pF—less than 0.6 percent higher than the value stamped on them. Three DMCP-291s in parallel would make a good calibration value of 873 pF. While in theory you only need one capacitor for calibration, with several you can see how consistent the tester is and be more confident about its accuracy.

While not precision values, All Electronics also has many 5 percent dipped mica capacitors. The following will work fine as the tank circuit capacitors: DMCP-47, 47 pF; DMCP-100P, 100 pF with pc board leads; DMCP-1K, 1000 pF.

transmitter VFO. A rigid box minimizes frequency changes from the mechanical stress of connecting the component being tested, so as a precaution I strengthened it with two pieces of aluminum angle stock. The oscillator is completely enclosed in order to prevent air drafts from causing short-term frequency changes.

The oscillator used a 2N5245 JFET. A somewhat wider range of gain is possible in a MPF102, but in most cases a MPF102 will work fine. In the unlikely event that a correctly wired oscillator doesn't have enough gain to start, or stops when a 2000-pF test capacitor is connected, measure the power supply current of the non-oscillating oscillator circuit alone (disconnect the buffer from the power supply). If JFET current is

less than 3 mA, try another FET or select one with higher zero-bias drain current,  $I_{DSS}$ .

I wound the nominal 25- $\mu$ H tank coil on a T80-2 (red) powdered iron toroidal form\*\* and clamped it to the perfboard with a screw and fiber glass washer (see **Photo C**). Exact capacitor values aren't necessary. I used dipped mica tank capacitors, but NPO ce-

\*\*For best stability, I suggest using a slug-tuned ceramic form instead of a toroid core. Wind the coil so a minimal amount of correction (slug insertion into coil) is needed to achieve the desired inductance. Ed.

The author replies: "In this instrument long term stability isn't important, that comes out using the calculations. What's crucial is the SHORT term stability, especially when measuring very small component values. It's particularly crucial to ensure that the oscillator frequency won't change while connecting the part under test . . . while manipulating the binding posts, etc. I ended up using a toroidal coil, tightly clamped to the perfboard with a screw and nonmetallic washer, essentially for mechanical stability."

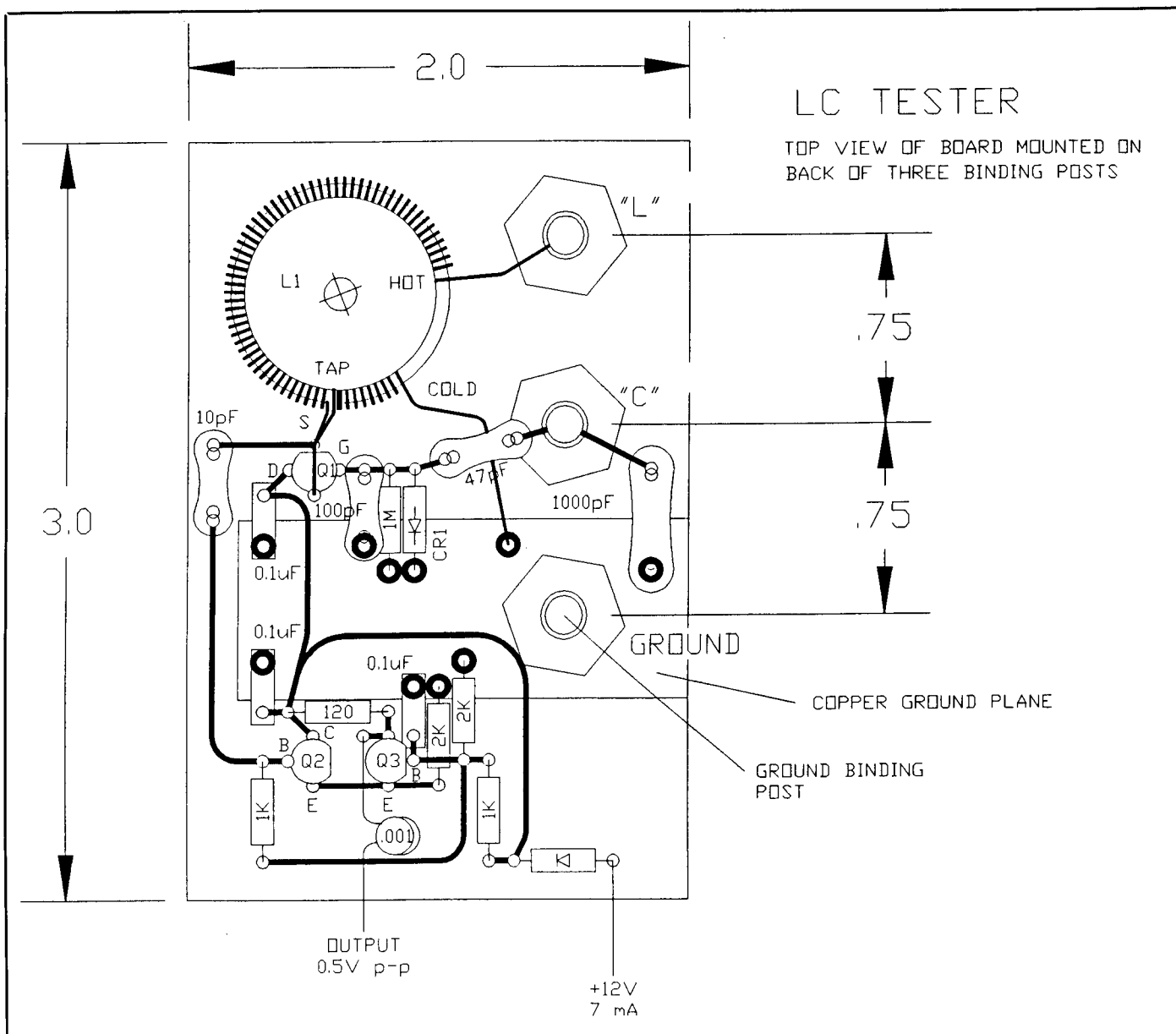

Figure 2. The oscillator and buffer layout on a 2 by 3 inch piece of perforated copperclad board.

ramic or polystyrene will also work. The 1000-pF capacitor can be several capacitors in parallel that add up to about 1000 pF. They should be mounted directly on the binding posts with minimum lead length. Leads of the 47 and 100 pF capacitors should also be short.

**Figure 2** shows the oscillator and buffer layout on a 2 by 3-inch piece of perforated copperclad board. Almost all of the copper was pulled off after scoring lines with an X-ACTO® knife, leaving a small patch for grounding. The board is supported on the back of three binding posts having 3/4-inch spacing. Other kinds of connections could serve just as well, but pay attention to their mechanical rigidity and keep the capacitor and ground leads short.

Twelve volts at about 7 mA is required; the frequency changes less than 2 cycles from 9 to 14 volts. The counter output signal is 0.5 volts p-p, well isolated by a two-transistor buffer.

## Calibration

Install a shorting wire\* between the L and C terminals. Verify that the oscillator is operating at about 1 MHz. Record the oscillator frequency; this is  $f_1$ . Now connect a known test capacitor, preferably around 1000 pF, between the C and GND terminals. This calibration capacitor should have leads no longer than 3/4 inch and stand vertically in the binding posts to minimize stray capacitance to ground. Record the new frequency,  $f_2$ . Calculate the effective capacitance of the oscillator tank,  $C_o$  as:

$$C_o = C_{cal} \frac{f_1^2}{f_1^2 - f_2^2} \quad (1)$$

$$L_o = \frac{1}{4\pi^2 f_1^2 C_o} \quad (2)$$

For example, if  $f_1 = 1005.984$  kHz, and connecting a 1000 pF, 1 percent capacitor for  $C_{cal}$  produces  $f_2 = 714.358$  kHz, then the tank capacitance  $C_o = 1017.16$  pF and the tank inductance  $L_o = 24.607$   $\mu$ H. These values of  $L_o$  and  $C_o$  should be stable. Check them each time you begin a group of mea-

\*The jumper should be a straight tinned wire, like a resistor lead. This has an inductance of about 0.006  $\mu$ H, which should be subtracted from all inductance measurements.

Originally, I used a carved piece of double-sided copperclad pc board material for the short between the L and C terminals because the self-inductance of a wide, thin strap is lower. However, the wide strap also had a capacitance of about 1/4 pF to the case. Removing that strap to measure a small inductor changed the oscillator capacitance by this 1/4 pF, so instead of improving the accuracy on small inductances, the wide strap resulted in an error of about 40 nH.

surements and record the values in a notebook. When you're confident that your values are stable, you won't need to perform calibrations as often.

The  $L_o$  and  $C_o$  values are used in measurement calculations that follow.

## Example: measuring an unknown capacitor

After you've calculated the value for  $C_o$ , connect an unknown capacitor, C, as shown in **Figure 3**, and record the new lower frequency  $f_2$ . Calculate the capacitor value as:

$$C = C_o \frac{f_1^2 - f_2^2}{f_2^2} \quad (3)$$

For example, if the connection of a capacitor marked 220 pF causes the frequency to drop from 1010 kHz to 910 kHz, it's value is:

$$1017.16 \times \left( \frac{1010^2 - 910^2}{910^2} \right) = 235.84 \text{ pF}$$

Because a 1-percent calibration capacitor was used, this will be within 1 percent + 0.1 pF, or 2.4 pF; the capacitor is between 233.4 and 238.3 pF.

If you need a specific capacitor value, the frequency it should produce in the LC Tester is:

$$f_2 = f_1 \sqrt{\frac{C_o}{C_o + C}} \quad (4)$$

If you need a 103-pF capacitor, and intend to try various 100-pF capacitors from your junkbox looking for this value, here's how to proceed. From the previous calculation you know that  $C_o$  is 1016.16 pF and  $f_1$  is 1010 kHz, so the frequency you'll be looking for is:

$$f_2 = 1,010,000 \times \sqrt{\frac{1017.16}{1017.16 + 103}} = 962,445 \text{ Hz}$$

As an alternative to trying every 100-pF capacitor in your junkbox, invest in five 75-pF and five 27-pF capacitors, costing about \$2. They will provide 25 combinations with nominal capacitance of 102 pF. Almost certainly, one of those combinations will be your desired 103 pF value, leaving eight capacitors for your junkbox.

## Example: measuring a small inductor in series

After calibrating and calculating  $L_o$ ,

record the  $f_1$  frequency with a piece of no. 22 wire shorting the L and C terminals. Then remove the wire and connect the unknown coil in its place (**Figure 4**); the measured frequency drops to  $f_2$ . The value of the coil is:

$$L = L_0 \frac{f_1^2 - f_2^2}{f_2^2} \quad (5)$$

For best accuracy with coils less than a few microhenries, subtract  $0.006 \mu\text{H}$  to compensate for the inductance of the shorting wire (see previous footnote for more information).

Alternatively, if you want a coil to have a specific inductance L, the frequency that coil should produce is:

$$f_2 = f_1 \sqrt{\frac{L_0}{L_0 + L}} \quad (6)$$

Suppose you need a 1.97 microhenry inductor for a QRP lowpass filter. *The Amidon Handbook\** says 20 turns on a T-50-6 (yellow) core will give 2 microhenries, so wind 20 turns of no. 28 wire on a swameet yellow core.

Using the same calibration value of  $f_1 = 1005.984 \text{ kHz}$  with the shorting wire, your toroid produces  $f_2 = 949.4 \text{ kHz}$ . **Equation 5** tells you the inductance is 3.02 microhenries! **Equation 6** tells you 1.97 microhenries should produce a  $f_2$  of 963.982 kHz. It would be more accurate to use  $1.97 + 0.006$ , or  $1.976 \mu\text{H}$ , for L in **Equation 6** to account for the inductance of the shorting wire.

To get up to 963 kHz you removed three turns, and spread the remaining seventeen more evenly over the core. You later realize the swameet core is 1/4-inch thick, while the Amidon core is 0.19-inch thick. The filter works fine because you compensated for the different core and have the correct inductance.

### Example: measuring a larger inductor in parallel

With the shorting wire between the L and C terminals in place, record  $f_1$ . Then connect the coil being measured between the C and GND binding posts. The frequency will increase to  $f_2$ . The calculation for the unknown inductance is:

$$L = L_0 \frac{f_1^2}{f_2^2 - f_1^2} \quad (7)$$

\*Amidon Associates, 2216 East Gladwick Street, Dominguez Hills, California 90220. (310)763-5770. Ask for free "Tech-Data" flyer, which shows inductance and Q produced by winding wire on a wide variety of their cores.

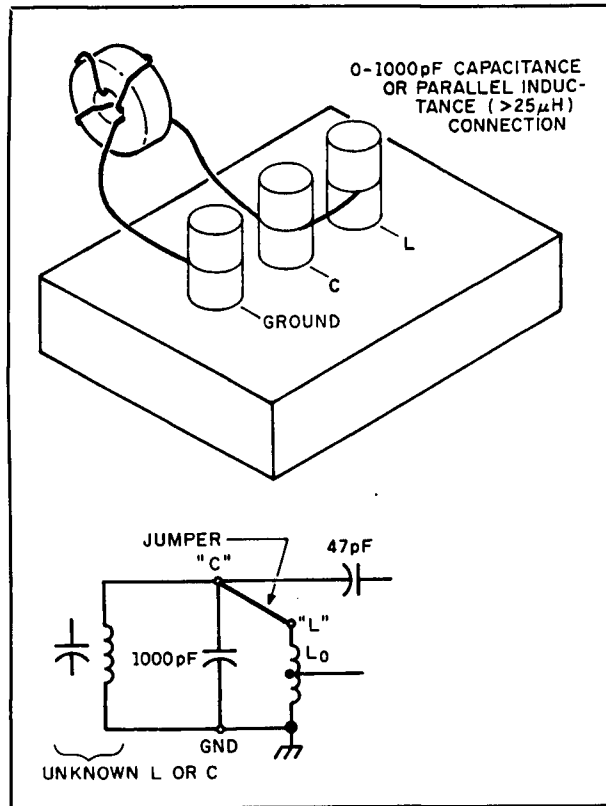

Figure 3. Connection for coils greater than  $25 \mu\text{H}$  ( $L_p$ , "parallel" connection) and capacitors.

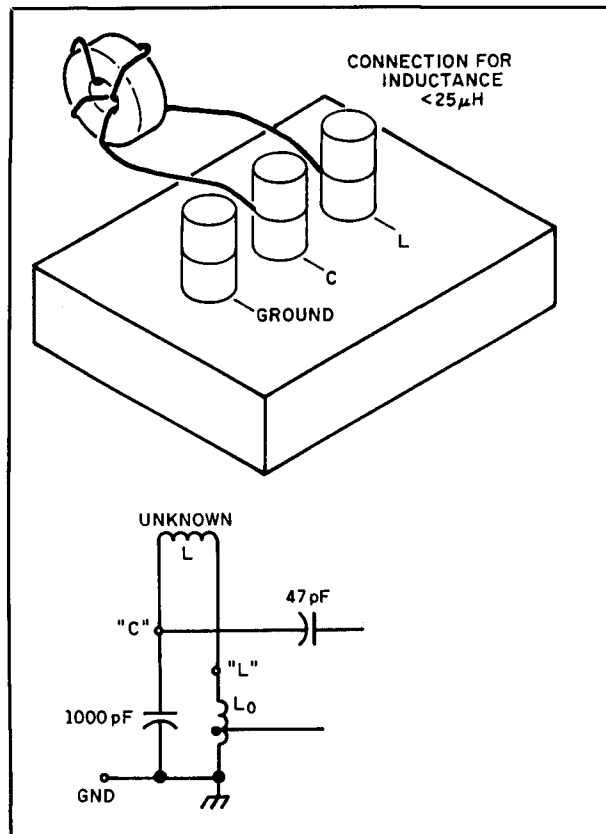

Figure 4. Connections for coils less than  $25 \mu\text{H}$  ( $L_s$ , "series" connection). Ground post is not used, unknown L replaces jumper between L and C posts.

```

program LC_TESTER;
uses crt;
var
  L, Lo, Lx, C, Co, Ct, f2, f1 : real; todo : char;

procedure CAL;
begin
  writeln('CALIBRATE');
  {enter calibration entries}
  write('ENTER the freq without CAL capacitor (Hz) : '); readln(f1);
  write('ENTER the freq with the CAL capacitor (Hz) : '); readln(f2);
  write('ENTER VALUE of the CAL capacitor (pF) : '); readln(Ct);
  {convert to picofards, calculate and print L and C of oscillator tank}
  Ct := Ct*1e-12; Co := Ct/(sqr(f1/f2)-1); Lo := 1/(Co*sqr(2*pi*f1));
  writeln('the tank capacitance is ',Co*1E12:4:2,' pF');
  writeln('the tank inductance is ',Lo*1E6:4:3,' uH'); writeln; writeln;
end;

procedure CAP;
{calculate unknown CAP from frequency measurements}
begin
  f2 := f1; while f2 >= f1 do
  begin
    {enter measured frequencies}
    write('ENTER the frequency without any capacitor (Hz) : '); readln(f1);
    write('ENTER the frequency with UNKNOWN capacitor (Hz) : '); readln(f2);
    if f2 >= f1 then writeln('second freq must be lower!');
  end;
  C := Co*(sqr(f1/f2)-1); writeln('UNKNOWN capacitor = ',C*1E12:4:2,' pF');
end;

procedure CFREQ;
{calculate the frequency that would be produced by a certain capacitance}
begin
  write('ENTER the free running frequency (Hz) : '); readln(f1);
  write('ENTER the capacitor value (pF) : '); readln(C); C:= C*1E-12;
  f2 := f1*sqr(Co/(Co+C));
  writeln('the frequency from ',C*1E12:4:2,' pF is ',f2*1E-3:4:3,' KHz');
end;

procedure INDUCT;
{calculate the inductance from frequency measurements}
begin
  write('ENTER the frequency WITH JUMPER (Hz) : '); readln(f1);
  write('ENTER the frequency with the inductor (Hz) : '); readln(f2);
  if f2>f1 then L := Lo*sqr(f1)/(sqr(f2)-sqr(f1)) else L := Lo*(sqr(f1/f2)-1);
  writeln('UNKNOWN inductor = ',L*1E6:4:3,' uH');
end;

procedure LSFREQ;
{calculate the frequency that would be produced by an inductance in series}
begin
  write('LSFREQ: ENTER the free running freq (Hz) : '); readln(f1);
  write('ENTER the inductor value (uH) : '); readln(L); L := L*1E-6;
  f2 := f1*sqr(Lo/(Lo+L));
  writeln('the frequency from ',L*1E6:4:3,' uH = ',f2*1E-3:4:3,' KHz');
end;

```

The frequency a desired parallel inductor, L, will produce is:

$$f_2 = f_1 \sqrt{\frac{L + L_0}{L}} \quad (8)$$

## Software: mechanizing the calculations

The calculations are error-prone and terminally tedious to do by hand, but a programmable calculator or personal computer on the bench makes the process practical.

**Listing 1** is a Turbo Pascal listing of a simple program for calibrating, then calculating component values from frequency measurements.\*\*

\*\*Microcomputers and older software can have small maximum number sizes and accuracy limitations. Four "sanity checks" for the calculations are suggested:

- 1) "Calibrate" by entering  $f_1 = 1,000,000$ ,  $f_2 = 707,071$ , and  $C = 1000$  pF. The program should respond with  $C_0 = 1000$  pF,  $L_0 = 25.33$   $\mu$ H or something very, very close to these values.
- 2) Compute a "C" with  $f_1 = 1,000,000$  and  $f_2 = 900,000$ . The response should be  $C = 234.6$  pF.
- 3) Compute "L<sub>s</sub>" using  $f_1 = 1,000,000$ ,  $f_2 = 900,000$ . The response should be  $L_s = 5.942$   $\mu$ H.
- 4) Compute "L<sub>p</sub>" using  $f_1 = 1,000,000$ ,  $f_2 = 130,000$ . The response should be  $L_p = 36.71$   $\mu$ H.

```

procedure LPPFREQ;
{calculate the frequency that would be produced by an inductance in parallel}
begin
  write('LPPFREQ: ENTER the free running freq (Hz) : '); readln(f1);
  write('ENTER the inductor value (uH) : '); readln(L); L := L*1E-6;
  f2 := f1*sqrt(1+Lo/L);
  writeln('the frequency from ',L*1E6:4:3,' uH = ',f2*1E-3:4:3,' KHz');
end;

procedure get_cmd;
begin
  {get single character from keyboard and convert to upper case}
  readln(todo); todo := upcase(todo);
end;

begin
  clrscr; writeln('{ 1.0 - 11/02/92 - K6OLG }'); writeln;
  {Here's the program that gets keyboard entries, and calls the various
  calculating and value-printing procedures shown above}
  CAL;
  repeat
    writeln; writeln;
    writeln('PRESS U to find the value of an unknown ');
    writeln('PRESS F to find the Frequency produced by a desired componant');
    writeln('PRESS Q to QUIT');
    get_cmd;
    case todo of
      'U' : begin
        clrscr;
        writeln('PRESS C to find the value of an unknown Capacitor');
        writeln('PRESS L to find the value of an unknown Inductor');
        get_cmd;
        case todo of
          'C' : CAP;
          'L' : INDUCT;
        end;
      end;
      'F' : begin
        clrscr;
        writeln('PRESS C to find the Frequency produced by a desired capac');
        writeln('PRESS L to find the Frequency produced by a desired induc');
        get_cmd;
        case todo of
          'C' : CFREQ;
          'L' : begin
            writeln('S for the Frequency produced with a SERIES indu');
            writeln('P for the Frequency produced with a PARALLEL in');
            get_cmd;
            case todo of
              'S' : LSFREQ;
              'P' : LPPFREQ; end;
            end;
          end;
        end;
      end;
    end;
    writeln;
  until todo = 'Q';
end.

```

## Accuracy

With a few precautions, the accuracy of the instrument is determined by one calibration capacitor. *Note that accuracy will be undermined if the oscillator frequency changes while you connect the part to be measured.* The beefed-up sheet metal box is very sturdy, a small die cast box would be ideal. Avoid any temptation to put this in a plastic box; durability is important!

Oscillator stability isn't difficult to achieve at 1 MHz, and drift error can easily be made negligible. My oscillator drifts less

than 10 Hz in ten minutes, which will cause only 0.02 pF error in the value of a 10-pF capacitor. Still, don't allow too much time to elapse between measurement of  $f_1$  and  $f_2$ , or accuracy may suffer.

I checked a number of parts on a surplus Boonton 63H inductance bridge, 75B capacitance bridge, and my LC Tester calibrated with a 0.001- $\mu$ F 1/2-percent silvered mica capacitor:

**Small coils.** A molded inductor with "0.15" color code measured 0.1412  $\mu$ H on the Boonton bridge. The calculated induc-

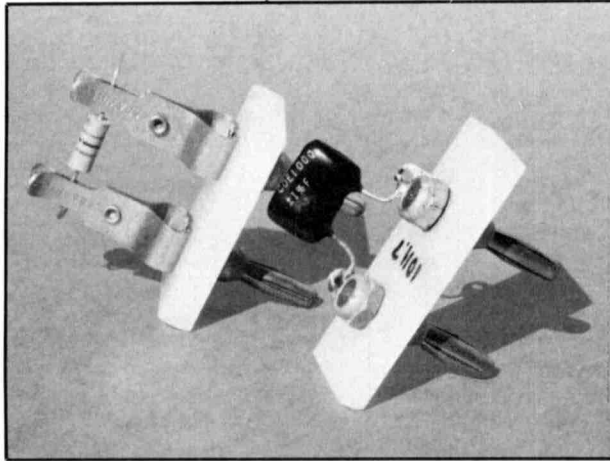
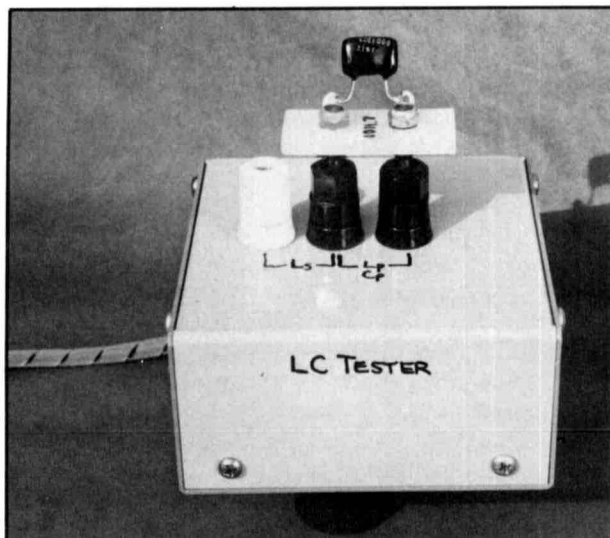

**Photo D.** A spring clip attachment holds the capacitor to be measured in place.

tance was  $0.1422 \mu\text{H}$ —0.7 percent higher than the bridge.

**Larger coils.** A molded inductor with “18” color code measured  $17.754 \mu\text{H}$  on the bridge. The calculated inductance was  $17.603 \mu\text{H}$ —0.9 percent lower than the bridge.

**Even larger coils: The parallel coil connection.** I measured molded chokes up to 100 microhenries with a few percent deviation from the bridge reading, but be aware that larger inductors frequently have large distributed capacitances. The instrument can’t tell how much a frequency change is due to inductance, and how much is due to stray capacitance! Distributed capacitance will make the calculated inductance higher than it really is, so be cautious before staking your life on readings in the parallel connection.



**Photo E.** Measuring the capacitor when directly attached to the LC tester’s binding posts yielded a slight change in frequency.

A 1.5-inch diameter, 4.9-inch long piece of Miniductor measured  $25.375 \mu\text{H}$  on a Boonton inductance bridge. When connected in *series* with the coil of the tester between C and L, the calculated inductance was  $25.364 \mu\text{H}$ —0.02 percent lower than the bridge. When connected in *parallel* with the coil of the tester, between C and GND terminals, it measured  $25.518 \mu\text{H}$ , or 0.56 percent higher. The difference could be attributed to 2.8 pF of distributed capacitance, but I couldn’t verify that with any of my test equipment. The accuracy was very good, but it points up one important fact: while this tester is quite accurate for the medium to high Q, low distributed capacitance coils that we normally use, it’s not an all-purpose substitute for a laboratory bridge that can measure the secondary parameters of a wide variety of components.

**Capacitors.** A silvered mica capacitor marked 110 pF, 1 percent measured 109.3 pF on the Boonton bridge. Using the spring clip attachment shown in **Photo D** to hold the capacitor, the tester gave a value of 109.51 pF—0.2 percent higher than the bridge. Although the frequencies changed when the capacitor was directly on the LC Tester’s binding posts (see **Photo E**), the second calculated value was 109.59 pF. The small additional capacitance of the spring clips shown didn’t compromise accuracy.

**Small capacitors.** A disk ceramic capacitor marked “2.7 NPO” had a calculated value of 2.38 pF, while the surplus capacitance bridge measured it as 2.432 pF—a difference of 0.05 pF—only 2 percent high for this very small capacitor.

I tested the capacitor by attaching the leads directly to the binding posts. If an exact value or matching a pair is very critical, put the capacitor in the same position relative to the surrounding grounded surfaces at the location where it will be used.

**Large capacitors.** The 2000-pF limit is arbitrary and conservative. Measurement accuracy is still the same as the calibration capacitor accuracy. At 1 MHz for capacitors above a few hundred pF, the series inductance of wire leads changes the apparent capacitance. Keep leads short when testing *and when using* larger values in circuits operating above 1 MHz requiring close tolerance. Full-length leads on a 1000-pF DM15 mica capacitor change the apparent capacitance by about 1 pF.

A silvered mica capacitor marked 1300 pF, 1 percent measured 1302.9 pF on the bridge. Frequencies from the tester gave a calculated value of 1301.45 pF—0.11 percent lower than the bridge.



A 2096 pF, 1 percent mica capacitor couldn't easily be measured on the bridge. The LC Tester gave a value of 2106.38 pF with 0.5-inch leads, 0.5 percent higher than its nominal value.

When the capacitor gets too large the oscillator simply stops. This oscillator operated at 5000 pF, but a 0.01  $\mu$ F mica capacitor caused it to stop.

## Semiconductor capacitances

The tank circuit can put up to 25 volts p-p on the capacitor being tested. This is too much for semiconductors, making this tester useful only for fixed capacitors.

## Next: A self-contained instrument?

If you have a PC or calculator and frequen-

cy counter, the LC Tester will provide accurate inductor and capacitor measurement at very little expense. If used frequently, it's possible that the convenience of putting the LC meter circuits, counter, and calculator in one package might be justified. If  $C_0$  is precisely adjusted to some known value, say 1000 pF, the premeasurement calibration step, with its need for a keyboard entry, could be eliminated. I'm currently building a self-contained instrument with built-in microcomputer and LCD display to test its practicality and see how stable the calibration will be with temperature changes and the passage of time.

## Acknowledgements

Thanks to Mike Berman, ex-K6RIW, for his photographic expertise.

# PRODUCT INFORMATION

## Relays and Accessories Guide on Floppy Disk

Philips ECG has released its newly-expanded Relays and Accessories Cross Reference guide on floppy disk for IBM PCs and compatibles.

This program, that contains the same reference data base as the new sixth edition catalog, allows users to access the entire replacement relays data base of over 39,500 industry numbers on their personal computers, crossed to over 530 ECG relays and accessories. CompuCross displays the full ECG relay type description, including relay style, input voltage, contact arrangement and current rating; and a reference to any special note that applies. With an access time less than a second, it also displays a list of manufacturers of the relay type to be replaced.

Requirements for using CompuCross include 512k of RAM, a hard drive and 3-1/2 or 5-1/4" floppy disk drive.



The ECG product line comprising this data base includes replacements for electro-mechanical relays, definite purpose magnetic contactors, reed, solid state, DIP and time delay, as well as an array of cube timers and standard and slim line I/O modules.

For more information contact Philips ECG, 1025 Westminster Drive, Williamsport, PA 17701, (800) 526-9354.

## Jensen's 1993 Master Catalog Available

Jensen Tools has a new 284-page master catalog that includes OSHA-required insulated tool sets (VDE certified), magnetic screwdrivers, and other hard-to-find tools for electrical and electronic installation and repair. For a free copy of the catalog write Jensen Tools Inc., 7815 S. 46th Street, Phoenix, Arizona 85044, or call (602) 968-6231 or FAX (800) 366-9662.

## Application note on Microsoft® Windows DDE protocols available

A new application note, "Utilizing DDE for Test and Measurement Applications," is available from Hewlett-Packard Company. The note (Literature 5091-2950E, Application Note 1219-1) explains the Dynamic Data Exchange (DDE) protocol feature of Microsoft Windows 3.0, and provides the information you need to use it in test-and-measurement applications.

To obtain a free copy of this application note, contact Hewlett-Packard Company Inquiries, 19310 Pruneridge Avenue, Cupertino, California, 95014.